



# PRODUCT CATALOGUE

General Surgical Instruments

# General Surgical Instruments

## INDEX

- **SCISSORS MICRO SCISSORS**
- **MICRO & GENERAL NEEDLE**
- **HOLDER GENERAL FORCEPS**
- **DISSECTING FORCEPS**
- **MICRO FORCEPS**
- **SELF RETAINING RETRACTOR**
- **GENERAL RETRACTOR**
- **ELEVATORS**
- **RECTAL INSTRUMENTS**
- **GYNECOLOGY INSTRUMENTS**
- **ORTHO & NEURO INSTRUMENTS**
- **CARDIOLOGY INSTRUMENTS**
- **GENERAL INSTRUMENTS**
- **NEEDLES**
- **SUCTIONS**
- **BLADES & HANDLES**
- **BIPOLAR INSTRUMENTS**
- **LARYNGOSCOPE**
- **GENERAL & HOLLOWARE & TRAY ETC**
- **SUCTION MACHINE & LIGHT SOURCE**

# SCISSORS



**METZENBAUM SCISSORS**  
CURVED

- 5"
- 6"
- 7"
- 8"
- 9"
- 10"



**S.S**

**METZENBAUM SCISSORS**  
STRAIGHT

- 5"
- 6"
- 7"
- 8"
- 9"
- 10"



**S.S**

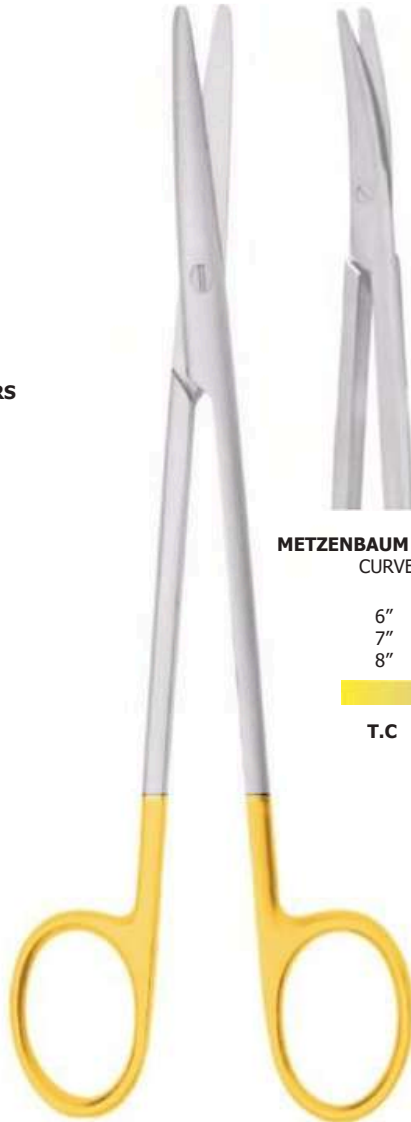

**METZENBAUM SCISSORS**  
CURVED

- 6"
- 7"
- 8"



**T.C**

**METZENBAUM SCISSORS**  
STRAIGHT

- 6"
- 7"
- 8"



**T.C**

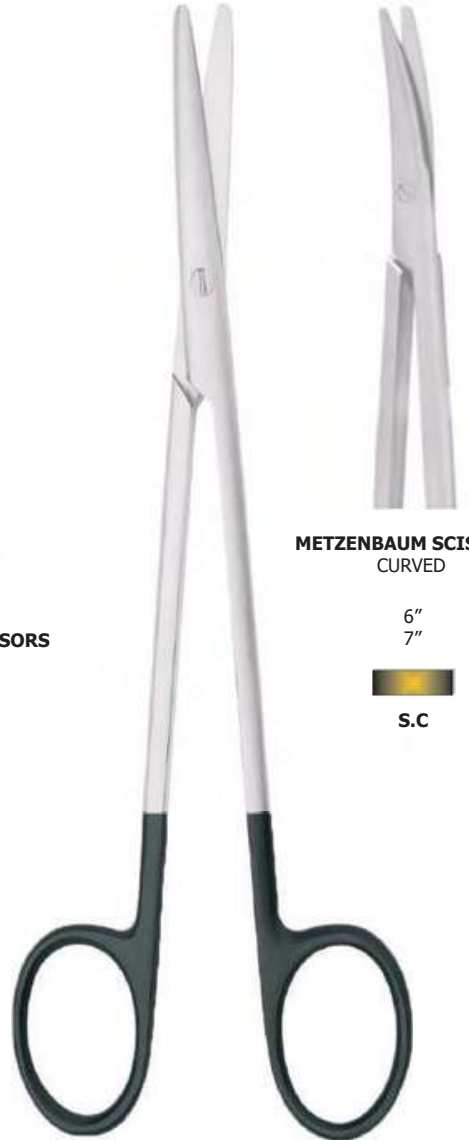

**METZENBAUM SCISSORS**  
CURVED

- 6"
- 7"



**S.C**

**METZENBAUM SCISSORS**  
STRAIGHT

- 6"
- 7"



**S.C**

# SCISSORS



**METZENBAUM SCISSORS**  
CURVED

- 5"
- 6"
- 7"
- 8"
- 9"
- 10"



**S.S**

**METZENBAUM SCISSORS**  
STRAIGHT

- 5"
- 6"
- 7"
- 8"
- 9"
- 10"



**S.S**

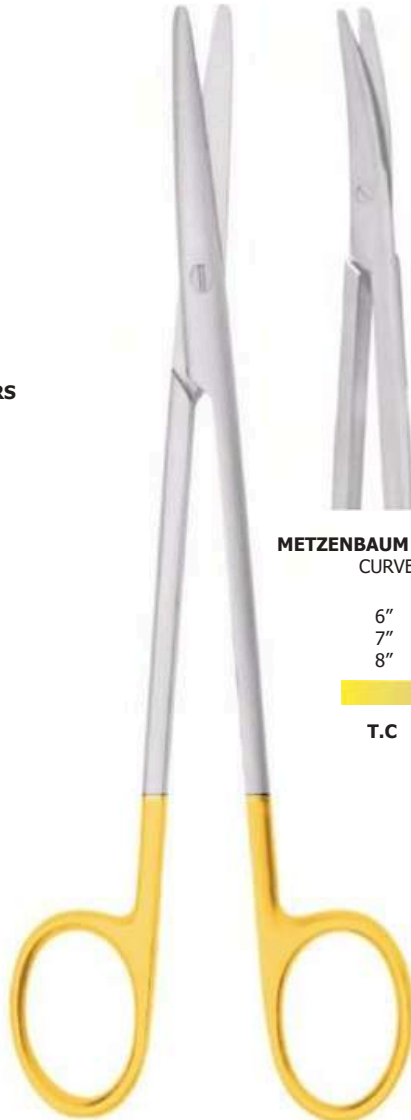

**METZENBAUM SCISSORS**  
CURVED

- 6"
- 7"
- 8"



**T.C**

**METZENBAUM SCISSORS**  
STRAIGHT

- 6"
- 7"
- 8"



**T.C**

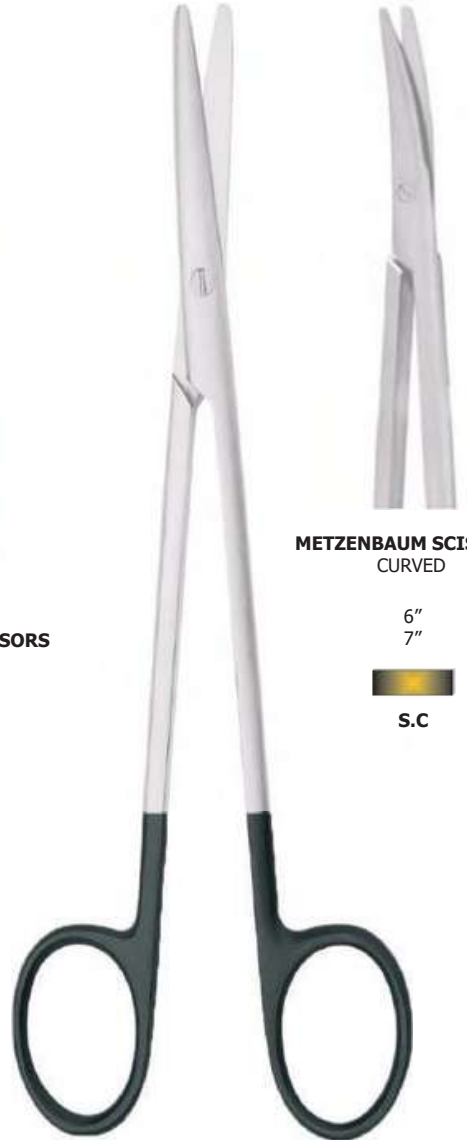

**METZENBAUM SCISSORS**  
CURVED

- 6"
- 7"



**S.C**

**METZENBAUM SCISSORS**  
STRAIGHT

- 6"
- 7"



**S.C**

# SCISSORS



**MAYO SCISSORS**  
STRAIGHT

5½"  
6½"  
7½"  
8½"  
9½"  
10½"



**S.S**



**MAYO SCISSORS**  
CURVED

5½"  
6½"  
7½"  
8½"  
9½"  
10½"



**S.S**



**MAYO SCISSORS**  
STRAIGHT

5½"  
6½"  
7½"  
8½"



**T.C**



**MAYO SCISSORS**  
CURVED

5½"  
6½"  
7½"  
8½"



**T.C**



**MAYO SCISSORS**  
STRAIGHT

6½"  
7½"



**S.C**



**MAYO SCISSORS**  
CURVED

6½"  
7½"



**S.C**

# SCISSORS



S.S

5"  
6"

T.C

6"



**DRESSING SCISSORS**  
 STRAIGHT (SHARP x SHARP)



S.S

5"  
6"

T.C

6"



T.C

6"



**DRESSING SCISSORS**  
 STRAIGHT (SHARP x BLUNT)



S.S

5"  
6"

T.C

6"



**GAUGE**  
 CUTTING SCISSORS  
 9"



**UMBILICAL CORD**  
 SCISSORS- 4.25"



**Heath Suture**  
 REMOVAL SCISSORS



**Lister Bandage**  
 SCISSORS  
 5 1/2"  
 7 1/2"



**EPISIOTOMY**  
 SCISSORS

# SCISSORS



**STEVENS SCISSORS**  
STRAIGHT

4 1/2"



**S.S**

**STEVENS SCISSORS**  
CURVED

4 1/2"



**S.S**



**STEVENS SCISSORS**  
STRAIGHT

4 1/2"

5 1/2"



**T.C**

**STEVENS SCISSORS**  
CURVED

4 1/2"

5 1/2"



**T.C**



**STEVENS SCISSORS**  
STRAIGHT

4 1/2"

5 1/2"



**S.C**

**STEVENS SCISSORS**  
CURVED

4 1/2"

5 1/2"



**S.C**



**GREEN BERG SCISSORS**  
STRAIGHT

5 1/2"



**S.S**

**GREEN BERG SCISSORS**  
CURVED

5 1/2"



**S.S**



**GREEN BERG SCISSORS**  
STRAIGHT

5 1/2"

6 1/2"



**T.C**

**GREEN BERG SCISSORS**  
CURVED

5 1/2"

6 1/2"



**T.C**



**GREEN BERG SCISSORS**  
STRAIGHT

5 1/2"

6 1/2"



**S.C**

**GREEN BERG SCISSORS**  
CURVED

5 1/2"

6 1/2"



**S.C**

# SCISSORS



**KNAPP SCISSORS**  
CURVED  
4 1/2"  
S.S



**KNAPP SCISSORS**  
CURVED  
4"  
5"  
T.C



**KNAPP SCISSORS**  
CURVED  
4"  
5"  
S.C

**KNAPP SCISSORS**  
STRAIGHT  
4 1/2"  
S.S

**KNAPP SCISSORS**  
STRAIGHT  
4 1/2"  
5 1/2"  
T.C

**KNAPP SCISSORS**  
STRAIGHT  
4 1/2"  
5 1/2"  
S.C



**IRIS SCISSORS**  
CURVED  
3 1/2"  
4"  
5"  
S.S



**IRIS SCISSORS**  
CURVED  
3 1/2"  
4"  
5"  
T.C



**IRIS SCISSORS**  
CURVED  
4"  
5"  
S.C

**IRIS SCISSORS**  
STRAIGHT  
3 1/2"  
4"  
5"  
S.S

**IRIS SCISSORS**  
STRAIGHT  
3 1/2"  
4"  
5"  
T.C

**IRIS SCISSORS**  
STRAIGHT  
4"  
5"  
S.C

# SCISSORS



**Gorney**  
Face Lift Scissors 19cm  
T.C.



T.C



**SOLZ**  
mammoplasty facelift scissor  
8"  
6"



S.C



**JAMISON METZENBAUM**  
SCISSORS NARROW  
TIP BLUNT CURVED  
9"  
7"  
6"



T.C



**Metzenbaum**  
FINE TIP Scissors  
15cm  
18cm  
20cm



T.C



**Metzenbaum**  
Dissecting Scissors Angled 8"



T.C

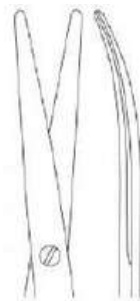

**JOSEPH SCISSOR**  
15CM/6"

STRAIGHT      CURVED



S.S



T.C



S.C



# SCISSORS



**WIRE CUTTER**  
SCISSORS

■ S.S    ■ T.C



**O'BRIEN STICH**  
REMOVING ANGLED  
SCISSORS

■ S.S  
■ T.C



**WALTER SCISSORS**  
CURVED ANGLED 10CM

■ S.S    ■ T.C



**KELLY SCISSORS**  
Straight 16cm-6 1/4"

■ S.S    ■ T.C



**Pott's Angled**  
Scissors 8"

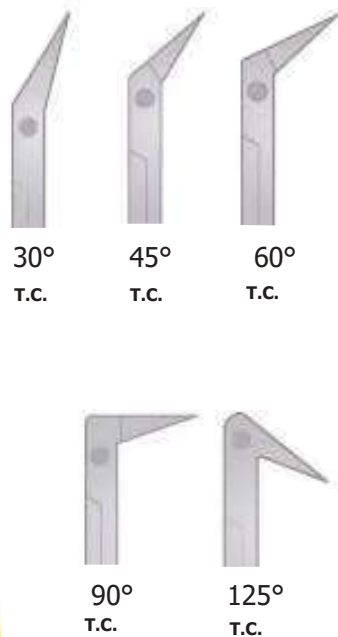

■ T.C  
■ S.S  
■ T.C





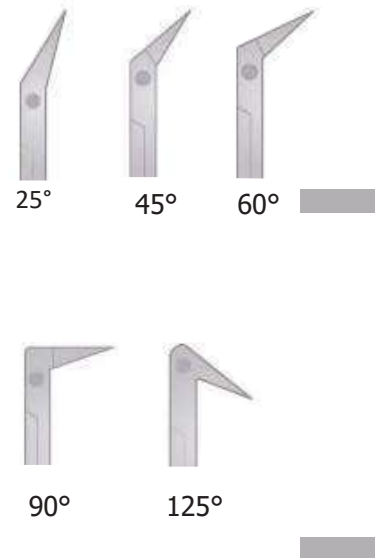





**MICRO ANGLED SPRING**  
SCISSORS 17 cm











## MICRO SPRING SCISSORS FLAT HANDLE



	<b>SIZE</b>		<b>SIZE</b>		<b>SIZE</b>
	6"		7"		8"
<b>S.S</b>		<b>S.S</b>		<b>S.S</b>	
	6"		7"		8"
<b>T.C</b>		<b>T.C</b>		<b>T.C</b>	
	6"		7"		8"
<b>TITANIUM</b>		<b>TITANIUM</b>		<b>TITANIUM</b>	

## MICRO SCISSORS SPRING ROUND HANDLE



	<b>SIZE</b>		<b>SIZE</b>		<b>SIZE</b>
	6"		7"		8"
<b>S.S</b>		<b>S.S</b>		<b>S.S</b>	
	6"		7"		8"
<b>T.C</b>		<b>T.C</b>		<b>T.C</b>	
	6"		7"		8"
<b>TITANIUM</b>		<b>TITANIUM</b>		<b>TITANIUM</b>	

## DENNIS MICRO SCISSORS SPRING STRAIGHT HANDLE, DOUBLE ACTION, 18.4CM



STRAIGHT    CURVED

S.S

# MICRO SCISSORS



**YASARGIL**



**UPWARD**  
22.5cm/9"

**TITANIUM**



**STRAIGHT**  
22.5cm/9"

**TITANIUM**



**DOWNWARD**  
22.5cm / 9"



**UPWARD**  
22.5cm / 9"  
24.5cm/9¾"

**T.C**



**STRAIGHT**  
22.5CM  
24.5CM  
22.5CM  
**T.C**  
T.C



**YASARGIL**



## CASTROVIEJO SCISSORS

Tips, 105mm length

Flat Handle Scissors

Round Handle Scissors



S.S



TITANIUM



## VANNAS SCISSORS

Sharp Tips

Straight  
Curved  
Angled 45°



S.S



TITANIUM



## WESTCOTT CURVED TENOTOMY SCISSORS

SHARP  
BLUNT



S.S



TITANIUM

# NEEDLE HOLDER

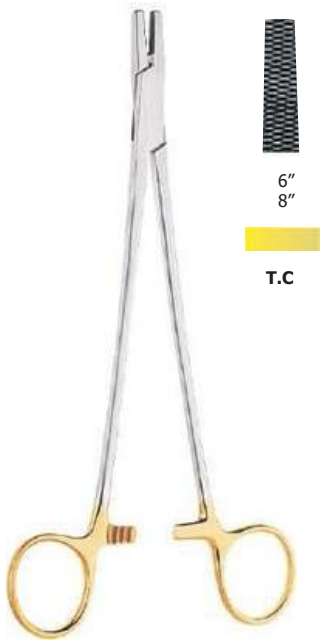

6"  
8"



T.C

**WIRE TWISTER**

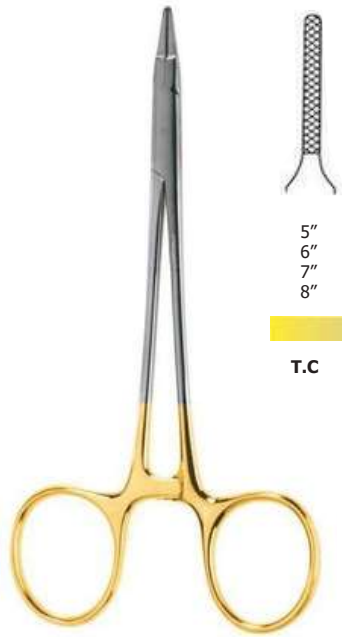

5"  
6"  
7"  
8"



T.C

**RYDER NEEDLE HOLDER**

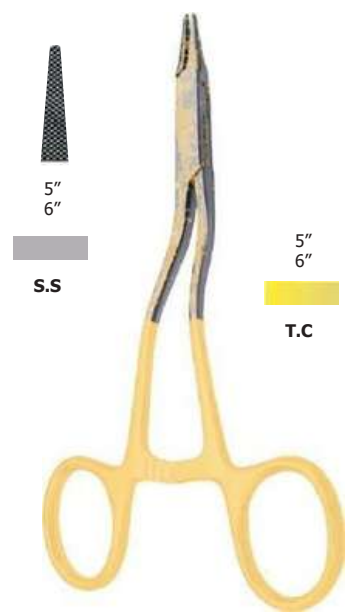

5"  
6"



S.S



T.C

**KILNER NEEDLE HOLDER**

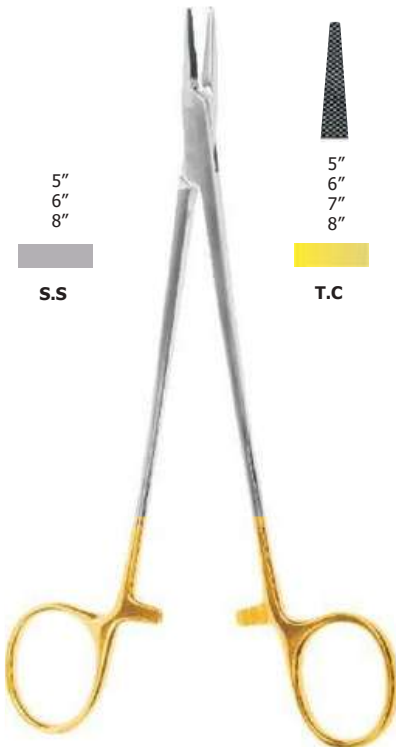

5"  
6"  
7"  
8"



T.C

5"  
6"  
8"



S.S

**MICRO VASCULAR NEEDLE  
HOLDER**



5"  
6"



Titanium

**MICRO VASCULAR NEEDLE  
HOLDER**



S.S



T.C

**OLSEN HAGAR NEEDLE HOLDER  
(WITH SCISSOR)**

# NEEDLE HOLDER

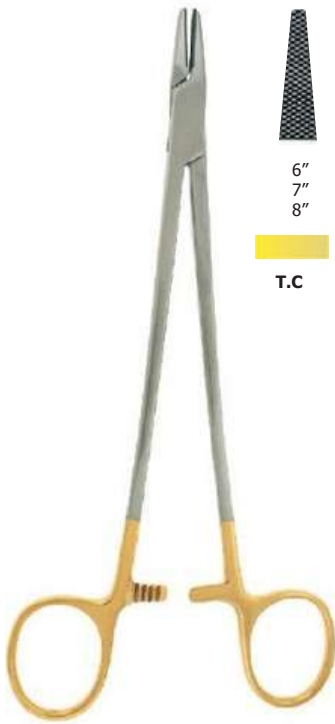

6"  
7"  
8"



T.C

**MAYO HEGAR NEEDLE HOLDER**

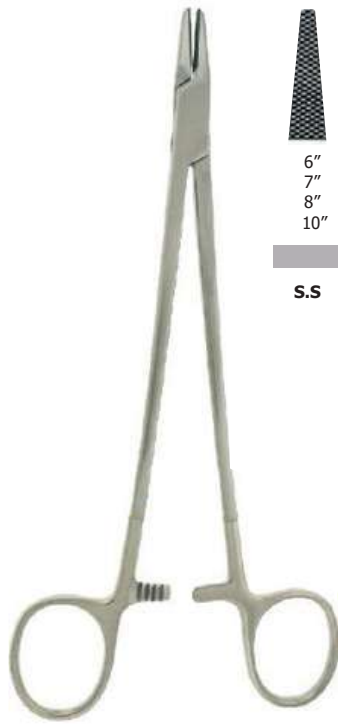

6"  
7"  
8"  
10"



S.S

**MAYO HEGAR NEEDLE HOLDER**



5 1/2"  
8"



T.C

**MATHIEU NEEDLE HOLDER**



8"



T.C

**MAYO HEGAR NEEDLE HOLDER CURVED TIP**



8"



T.C

8"



S.S

**BOZEMAN NEEDLE HOLDER**



**MICRO SPRING NEEDLE HOLDER FLAT HANDLE**



**MICRO SPRINGNEEDLE HOLDER ROUND HANDLE**

**TITANIUM**

**FINE MICRO SPRING NEEDLE HOLDER FLAT HANDLE**



**Barraquer Needle Holder Fine Tip**

- Round Handle
- Available In with or without lock
- Straight & Curved
- Straight, withlock
- Straight without lock
- Curved withlock

   
Titanium Stainless Steel

**Barraquer Needle Holder Fine**

- Flat Handle
- Available In with or without lock
- Straight & Curved
- Straight, withlock
- Straight without lock
- Curved withlock
- Curved without lock

   
Titanium Stainless Steel



# MICRO NEEDLE HOLDER

## YASARGIL MICRO NEEDLE HOLDER BAYONET SHAPE

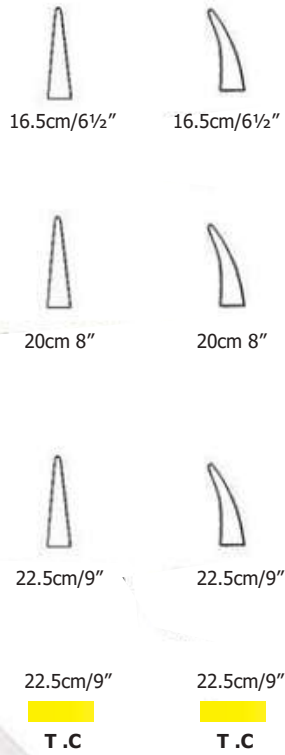
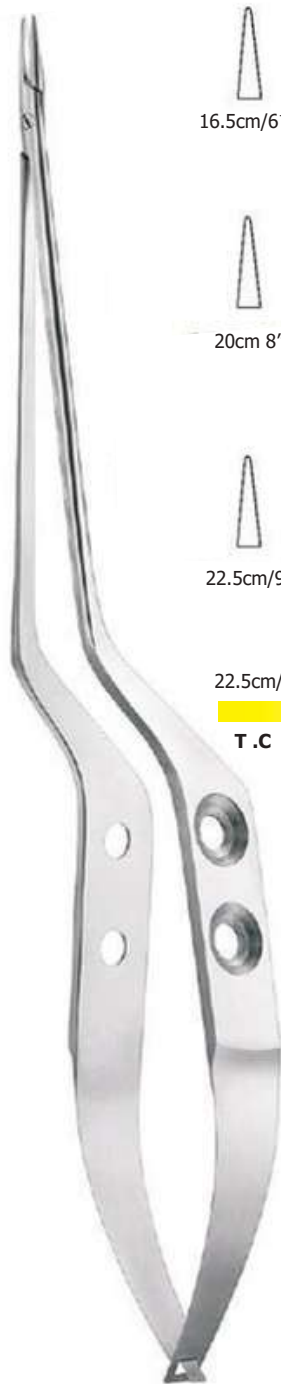

YASARGIL

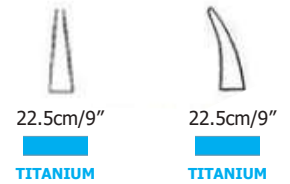

YASARGIL

# GENERAL FORCEPS

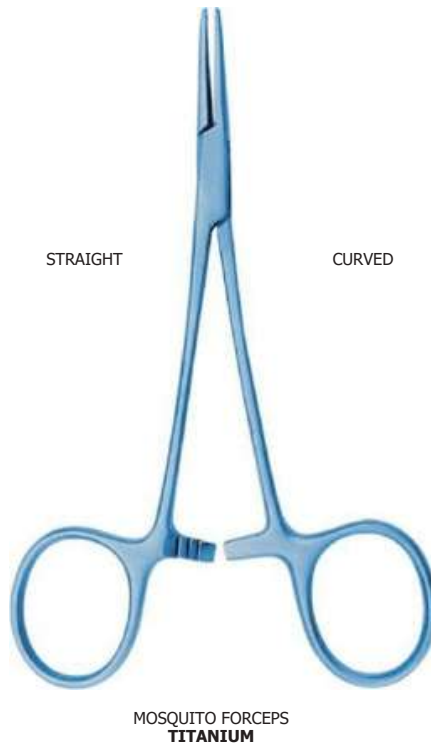
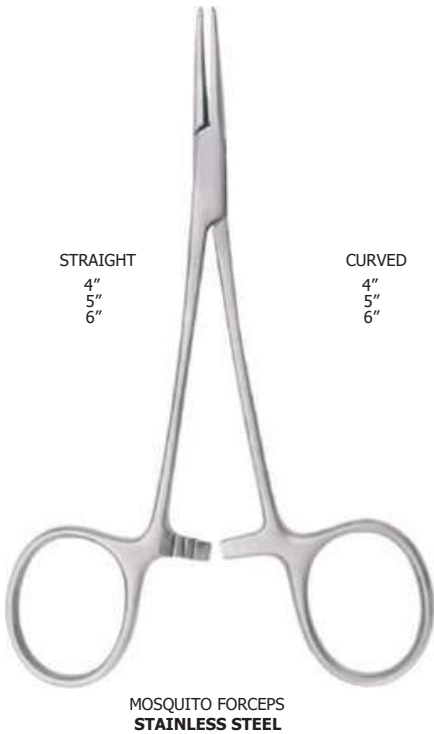
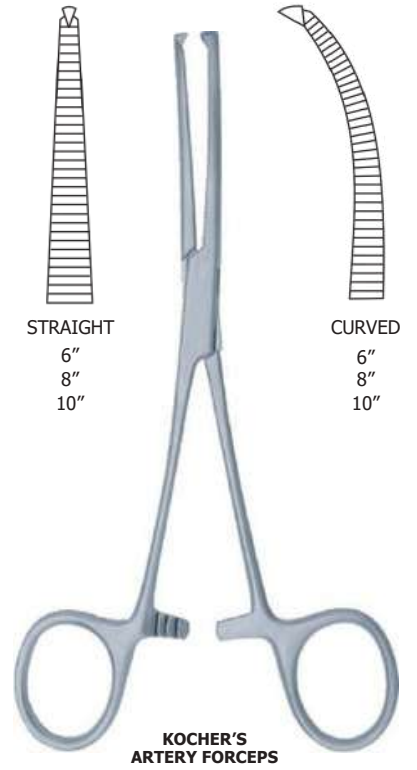
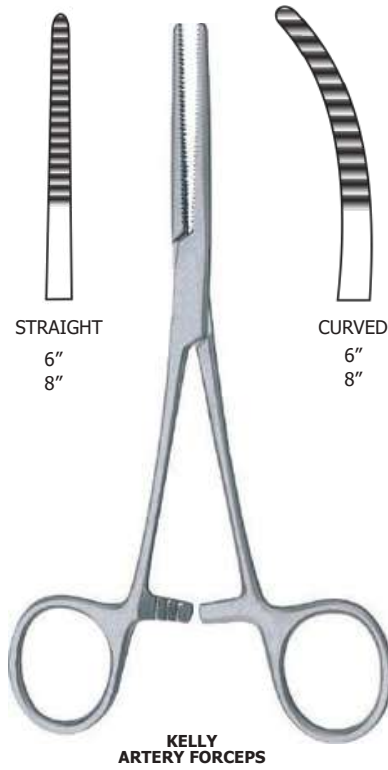
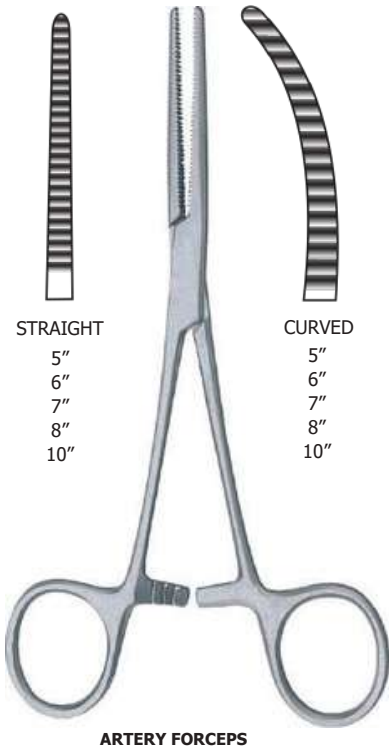

# GENERAL FORCEPS

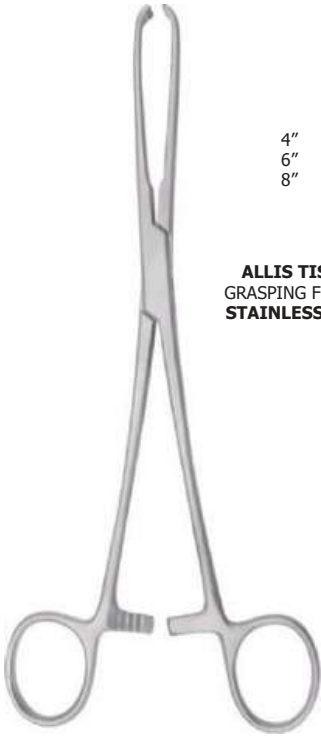

4"  
6"  
8"

**ALLIS TISSUE**  
GRASPING FORCEPS  
STAINLESS STEEL



6"

**ALLIS TISSUE**  
GRASPING FORCEPS  
TUNGSTEN CARBIDE

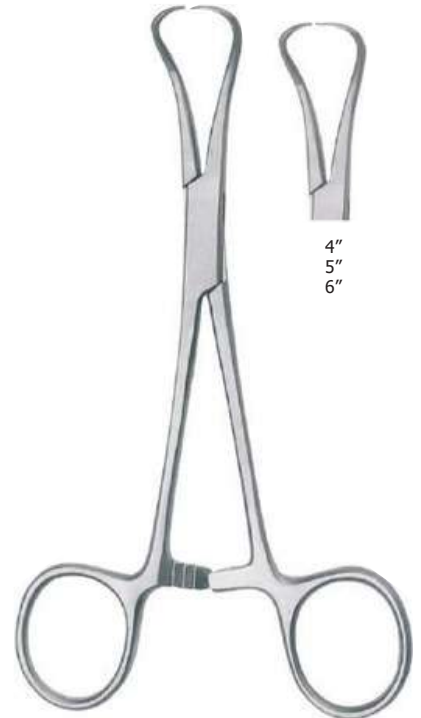

4"  
5"  
6"

**TOWEL FORCEPS**  
BACKHAUS

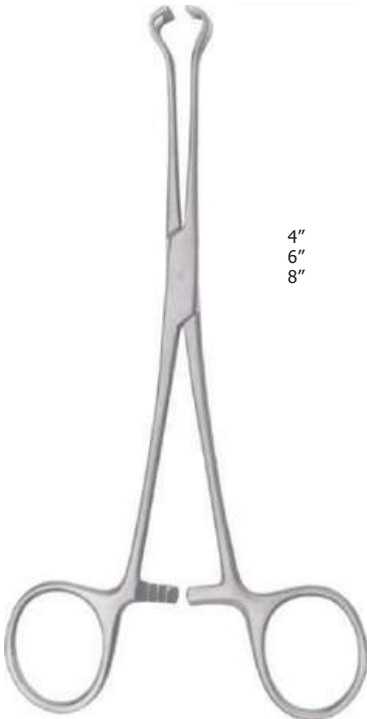

4"  
6"  
8"

**BAB COCK**  
GRASPING FORCEPS  
STAINLESS STEEL

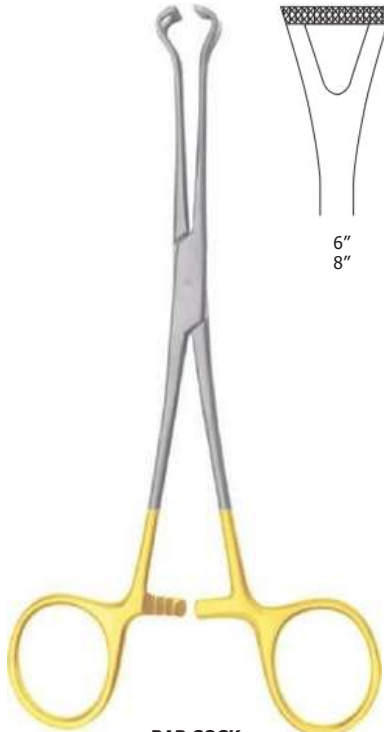

6"  
8"

**BAB COCK**  
GRASPING FORCEPS  
TUNGSTEN CARBIDE



**TOWEL CLIP**  
CROSS ACTION

# GENERAL FORCEPS



**HYSTERECTOMY  
MAINGOTS FORCEPS**  
STRAIGHT 8"



**HYSTERECTOMY  
MAINGOTS FORCEPS**  
CURVED 8"



**HYSTERECTOMY  
GWILLIAM FORCEPS**  
STRAIGHT 8"



**HYSTERECTOMY  
GWILLIAM FORCEPS**  
CURVED 8"



**HYSTERECTOMY CLAMP**  
DeBAKEY CLAMP

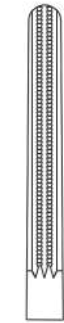

STRAIGHT



CURVED



HALF CURVED

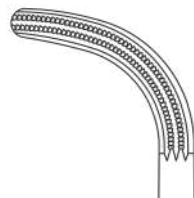

FULL CURVED



**KOVAC HYSTERECTOMY**  
TOOTH CLAMP



STARIGHT



CURVED

# GENERAL FORCEPS

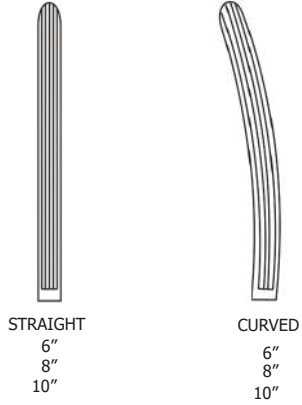

**DOYEN INTESTINAL CLAMP**



**HEANYS HYSTERECTOMY  
FORCEPS SINGLE TOOTH  
CURVED**



**HEANYS HYSTERECTOMY  
FORCEPS DOUBLE TEETH  
CURVED**



**MIXTURE LIGATURE  
RIGHT ANGLED FORCEPS**



**GREEN  
ARMYTAGE  
FORCEPS**



**LAHEY'S  
FORCEPS**

# GENERAL FORCEPS

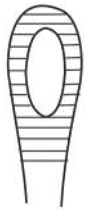

STRAIGHT

8"  
10"

**SPONGE**  
HOLDING FORCEPS



curved

12"

**KELLY**  
POLYPUS FORCEPS



STRAIGHT



CURVED



**TENACULUM**  
DOUBLE TEETH FORCEPS

# GENERAL FORCEPS



**CHEATLE**  
JAR



**UTERINE VULSELLUM**  
FORCEPS



**CHEATLE FORCEPS**



**LISTER SINUS**  
DRESSING FORCEPS

# GENERAL FORCEPS



**RENDALLS RENAL**  
FORCEPS

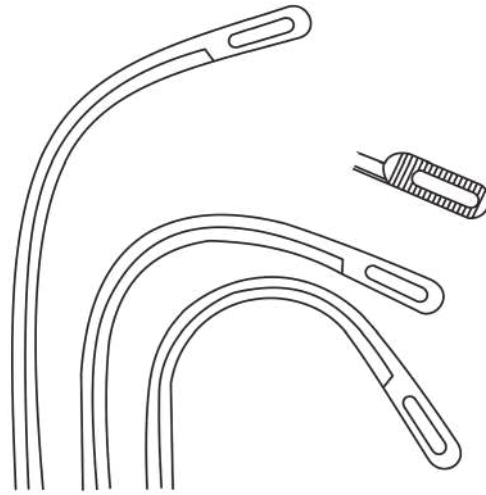

**BLADDER**  
STONE FORCEPS



**BLAKE**  
GALL BLADDER  
FORCEPS

# GENERAL FORCEPS



**PERFORATOR**  
SIMS FORCEPS



**VEIN STRIPPERS**

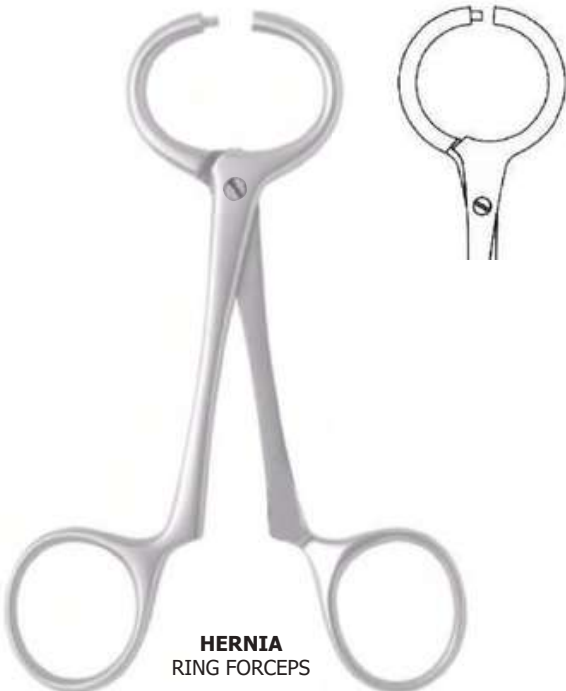

**HERNIA**  
RING FORCEPS



**BOWL LIFTING**  
FORCEPS  
12"



**MAYO SAFETY PIN**  
INSTRUMENT HOLDER

# DISSECTING FORCEPS

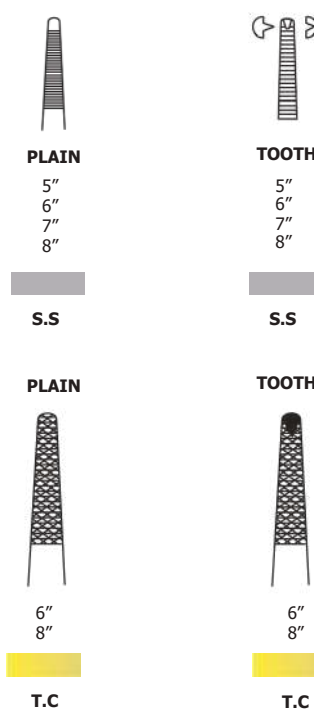
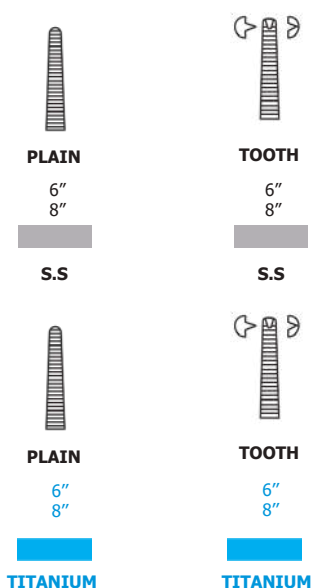

**DISSECTING FORCEPS**  
FINE

**DISSECTING FORCEPS**



**DENNIS BROWNE**  
DISSECTING FORCEPS



**RUSSIAN DISSECTING**  
FORCEPS

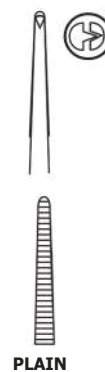

**GERALD FORCEPS**  
STRAIGHT NARROW 7"



**BROWN FORCEPS**  
8 x 8 TEETH

# DISSECTING FORCEPS

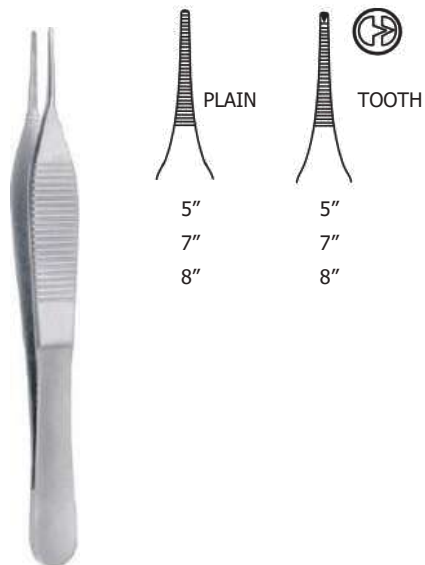

**ADSON FORCEPS**

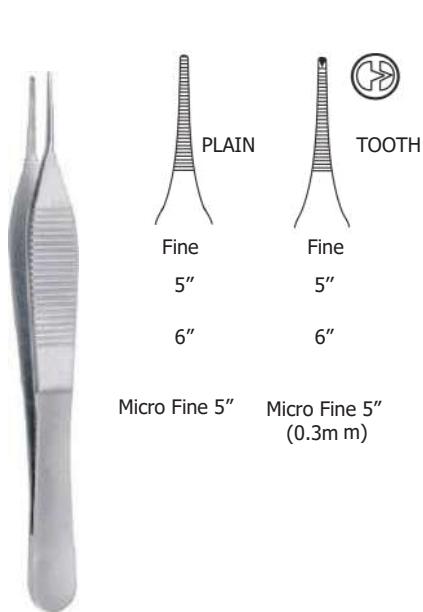

**ADSON FORCEPS**

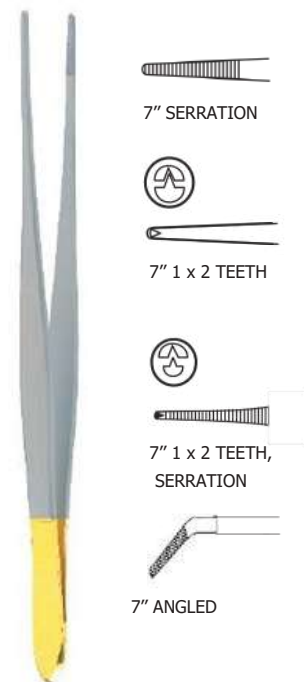

**CUSHING FORCEPS SEMI SHARP**  
DISSECTING END GUTSCH HANDLE

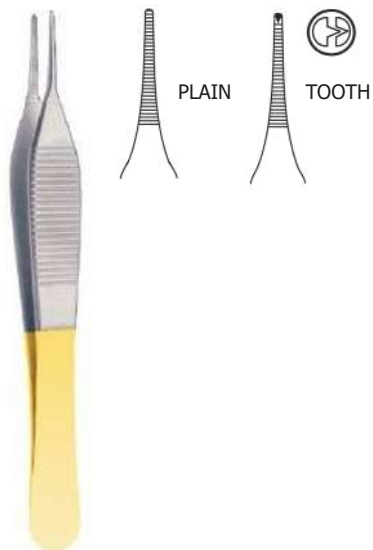

**ADSON FORCEPS**

PLAIN- 5"  
Fine



T.C

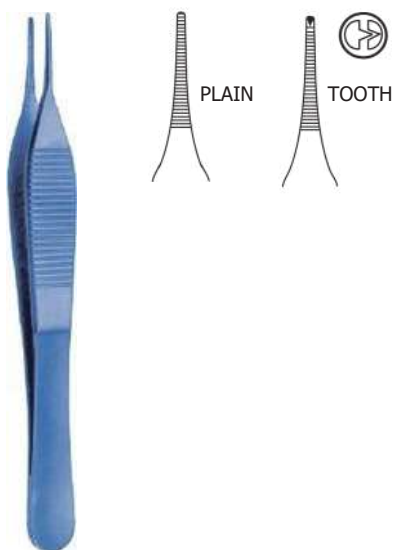

**ADSON FORCEPS**

PLAIN- 5"  
Fine



TITANIUM



**ADSON BROWN**  
FORCEPS 5"



T.C

# MICRO FORCEPS



**CROW INSULATED FORCEPS**  
9" STRAIGHT



**MAXWELL FORCEPS**  
9" CURVED



6"  
7"  
8"

**JANSEN BAYNOT**  
FORCEPS PLAIN



T.C

**JANSEN B AYNOT**  
FORCEPS PLAIN 6"



6"  
8"

**NELSON TISSUE**  
FORCEPS



**MICRO JEWELLERS**  
FORCEPS



ANGLED 5-A

S.S



No.5

S.S



TOOTHED  
No.5

S.S



No.3

S.S



No.7  
CURVED

S.S



TOOTHED No.5  
CURVED

S.S



ANGLED 5-A

TITANIUM



No.5

TITANIUM



TOOTHED  
No.5

TITANIUM



No.3

TITANIUM



No.7











TITANIUM



TOOTHED No.5

TITANIUM

# MICRO FORCEPS

											
	<b>PLAIN STRAIGHT</b>	<b>PLAIN CURVED</b>	<b>TEETH</b>	<b>TEETH CURVED</b>			<b>PLAIN STRAIGHT</b>	<b>PLAIN CURVED</b>	<b>TEETH</b>	<b>TEETH CURVED</b>	
	6" 8"	6" 8"	6" 8"	6" 8"			6" 8"	6" 8"	6" 8"	6" 8"	
		6" 8" ANGLED	6" 8" TOOTH	6" 8" TOOTH	<b>TITANIUM</b>			6" 8" ANGLED	6" 8" TOOTH	6" 8" TOOTH	<b>TITANIUM</b>
	6" 8" DIAMOND	6" 8" DIAMOND					6" 8" DIAMOND	6" 8" DIAMOND			

## MICRO FORCEPS ROUND HANDLE PLATFORM TIP

		
	<b>Plain</b>	<b>Teeth</b>
	<b>Titanium</b>	<b>Titanium</b>
	<b>S.S</b>	<b>S.S</b>

**CASTROVIEJO**  
FORCEPS with PLATFORM

## MICRO FORCEPS FLAT HANDLE PLATFORM TIP

		
	<b>Plain</b>	
	<b>Titanium</b>	
	<b>S.S</b>	

		
	<b>Plain</b>	<b>Teeth</b>
	<b>Titanium</b>	<b>Titanium</b>
	<b>S.S</b>	<b>S.S</b>

**SUTURE TYING**  
FORCEPS CURVED

**MCPHERSON TYING FORCEPS**  
FLAT HANDLE

## Mcpherson Tying Forceps



**GREEN FIXATION**  
FORCEPS

**S.S**

# MICRO FORCEPS

0.3mm      0.6mm



16cm/6¼"  
18cm/7"  
20cm/8"  
22cm/8¾"  
24cm/9½"

22cm/8¾"

**TITANIUM**      **TITANIUM**

22cm/8¾"

**DIAMOND TIP**      **DIAMOND TIP**

24cm/9½"

**DIAMOND TIP**      **DIAMOND TIP**



**YASARGIL  
MICRO FORCEPS**

Ø 3 mm      Ø 5 mm      Ø 7 mm

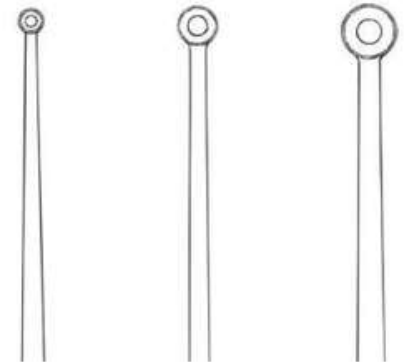

**JAW SPOON SHAPED**

22cm/8¾"  
24cm/9½"



Ø 3 mm      Ø 5 mm      Ø 7 mm

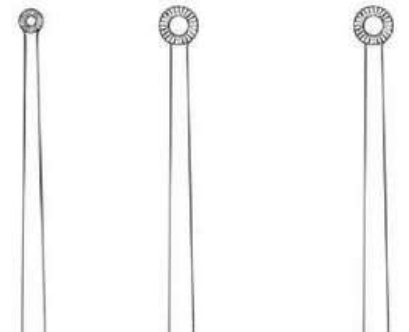

**SERRATED FLAT JAW**

22cm/8¾"

**TOOTH CURETTE JAW**

22cm/8¾"

# RETRACTORS



## SELF-RETAINING RETRACTORS

### WEITLANER STRAIGHT RETRACTOR

**LENGTH**

26cm 27mm 5x6 PRONGS SEMI SHARP  
26cm 27mm 5x6 PRONGS BLUNT

### WEITLANER CURVED RETRACTOR

**LENGTH**

26cm 27mm 5x6 PRONGS SEMI SHARP

### WEITLANER STRAIGHT RETRACTOR

**LENGTH**

13cm 18mm 3x4 PRONGS SIMI SHARP  
16cm 18mm 3x4 PRONGS SIMI SHARP  
20cm 21mm 3x4 PRONGS SIMI SHARP  
25cm 27mm 3x4 PRONGS SIMI SHARP  
20cm 21mm 4x5 PRONGS SIMI SHARP

**LENGTH**

13cm 18mm 3x4 PRONGS BLUNT  
16cm 18mm 3x4 PRONGS BLUNT  
20cm 21mm 3x4 PRONGS BLUNT  
25cm 27mm 3x4 PRONGS BLUNT

### WEITLANER CURVED RETRACTOR

**LENGTH**

20cm 21mm 3x4 PRONGS SIMI SHARP  
25cm 27mm 3x4 PRONGS SIMI SHARP  
20cm 21mm 4x5 PRONGS SIMI SHARP

### RETRACTOR

RIGHT BLADE 42mm, LEFT BLADE 22mm DEEP

**LENGTH**

29cm 22/42mm 6x6 PRONGS SEMI SHARP

### RETRACTOR

RIGHT BLADE 22mm, LEFT BLADE 42mm DEEP

**LENGTH**

29cm 22/42mm 6x6 PRONGS SIMI SHARP

# RETRACTORS



A



B



A

## SELF-RETAINING RETRACTORS

### MOLLISON

RETRACTOR

LENGTH

14cm,18mm 3x3 PRONGS SEMI SHARP  
14cm,18mm 3x3 PRONGS BLUNT  
14cm,18mm 3x4 PRONGS SEMISHARP  
14cm,18mm 3x4 PRONGS BLUNT  
16.5cm,18mm 3x4 PRONGS SEMISHARP  
16.5cm,18mm 3x4 PRONGS BLUNT

### BEEKMAN ADSON

RETRACTOR

LENGTH

31cm,37mm 4x4 PRONGS SEMI SHARP  
31cm,48mm 4x4 PRONGS SEMI SHARP  
31cm,37mm 4x4 PRONGS BLUNT  
31cm,48mm 4x4 PRONGS BLUNT

### CONE

RETRACTOR

LENGTH 16cm 18mm 3x4

PRONGS SHARP  
20cm 20mm 3x4 PRONGS SHARP  
26cm 27mm 3x4 PRONGS SHARP  
16cm 18mm 3x4 PRONGS BLUNT  
20cm 20mm 3x4 PRONGS BLUNT  
26cm 27mm 3x4 PRONGS BLUNT

### MAYO ADSON LEMOTOMY

RETRACTOR

LENGTH

31cm,27mm 4x5 PRONGS SIMI SHARP  
31cm,27mm 4x5 PRONGS BLUNT

# RETRACTORS

**LANGENBECK  
RETRACTOR  
SMALL**

25CM x 6MM  
35CM x 15MM



**LANGENBECK  
RETRACTOR  
LARGE**

45CM x 20MM  
65CM x 25MM  
75CM x 25MM  
90CM 25MM

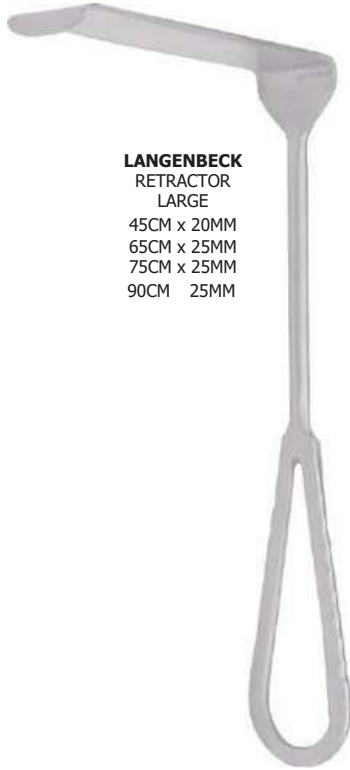

**LANGENBECK RETRACTOR  
WITH FIBER OPTIC LIGHT CARRIERS  
ALONG WITH SUCTION**

45CM x 20MM  
75CM x 25MM



**DOYEN RETRACTOR**

1"  
1½"  
2"  
2½"  
3"  
3½"  
4"



**DOYEN RETRACTOR  
WITH FIBER OPTIC  
LIGHT CARRIERS**

2½"



**KELLY RETRACTOR**

2"X1½"  
2½"X2"  
3"X2½"  
3½"X2¼"

# RETRACTORS



**VOLKMAN RETRACTOR**  
SHARP  
3 PRONG  
4 PRONG  
5 PRONG

**VOLKMAN RETRACTOR**  
BLUNT  
3 PRONG  
4 PRONG  
5 PRONG



**DEAVERS**  
RETRACTOR  
1/2" x 6"  
3/4" x 8"  
1" x 12"



**DEAVERS RETRACTOR**  
ADULT  
1 1/2" x 12"  
2" x 12"  
2 1/2" x 12"



**DEAVERS RETRACTOR**  
WITH FIBER OPTIC LIGHT CARRIER  
ADULT  
1 1/2" x 12"  
1" x 12"



**LOVER NERVE**  
ROOT RETRACTOR 22cm 5mm TIP WIDTH

STRAIGHT  
45° ANGLED  
90° ANGLED



**MORRIS RETRACTOR**  
1 1/2"  
2"  
2 1/2"  
3"



**MORRIS RETRACTOR**  
WITH FIBER OPTIC  
LIGHT CARRIER  
2 1/2"



**KELLY'S RETRACTOR**  
7203

# RETRACTORS



**CZERNY RETRACTOR**

6"  
8"



**S SHAPE RETRACTOR**  
3/8" WIDE

6"  
8"

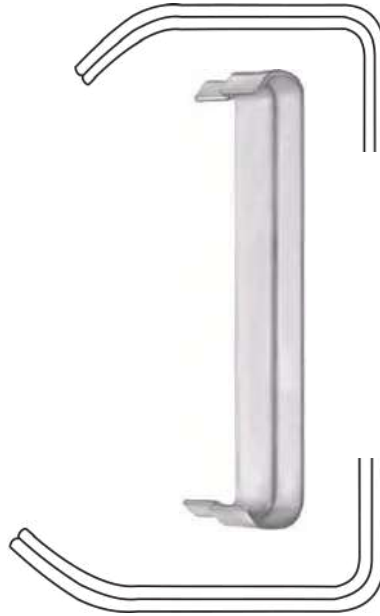

**LANE'S RETRACTOR**

SET OF 2



**ROUX RETRACTOR**

SET OF 3



**DAVIS MALLEABLE RETRACTOR**



**THYROID DISSECTOR**



**DISSECTOR**  
McDONALD



**JOLLS THYROID**  
RETRACTOR

# RETRACTORS



2009

**COTTLE**  
RETRACTOR  
BLUNT



2010

**COTTLE**  
RETRACTOR  
SHARP



2012

**COTTLE UPPER**  
RETRACTOR



P-12205

**JOSEPH**  
RETRACTOR  
FINE SHARP



MICRO FINE  
P-12462



3mm  
P-12353

**GILLIES**  
SKIN HOOK

5mm  
2011



**COTTLE UPPER**  
TEFION COATED RETRACTOR



**ROLLET RETRACTOR**  
4 SHARP PRONGS



**KILNER**  
RETRACTOR



SHARP  
7175



BLUNT  
2014



**RAGNELL RETRACTOR**  
16cm

# RETRACTORS



(BALFOUR) ABDOMINAL  
SELF - RETAINING RETRACTOR



POZZI SELF-RETAINING RETRACTOR  
WITH THREE BLADE



(BALFOUR) ABDOMINAL  
SELF - RETAINING RETRACTOR  
CHILD

# RETRACTORS



**PARKS ANAL**  
RETRACTOR



**MILLIAN BLADDER**  
RETRACTOR



**THOMSON WALKER BLADDER**  
RETRACTOR



**DIRECTOR WITH ANEURYSM**  
NEEDLE



**PENILE CLAMP**

# RETRACTORS

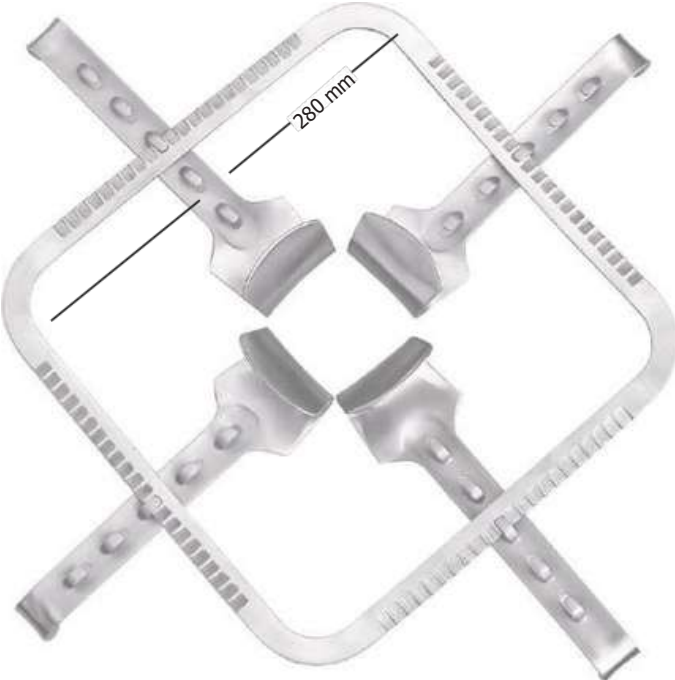

**ABDOMINAL RETRACTOR**  
KIRSHNER SET OF 4 BLADES

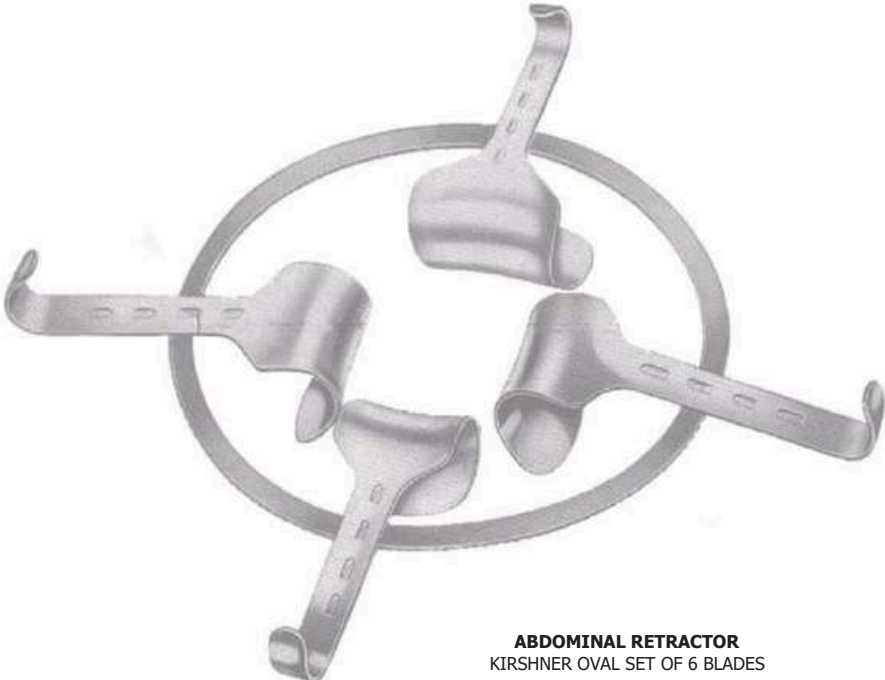

**ABDOMINAL RETRACTOR**  
KIRSHNER OVAL SET OF 6 BLADES

# RETRACTORS



**PLAIN**  
15CM X 30MM  
12CM X 25MM

**WITH TEETH**  
15CM X 30MM  
12CM X 25MM

**TEBBETTS RETRACTOR**  
WITH FIBER OPTIC ILLUMINATION  
& SUCTION TUBE

# ELEVAORS



**FREER**  
ELEVATOR BROAD



**DISSECTOR**  
WITH SUCCER



**RASPATORIEN**  
ROUND

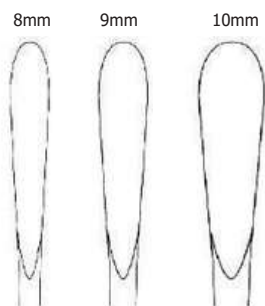
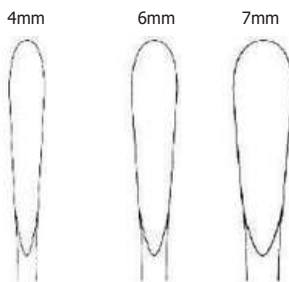

**RASPATORIEN**  
SHARP

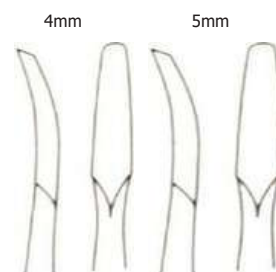
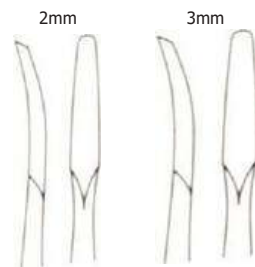

**COTTLE MCKENTY**  
ELEVATOR



**COHEN**  
ELEVATOR



**WILLIGER**  
RASPATORIEN



**OBWEGESER**  
RASPATORIEN



# RECTAL INSTRUMENTS



**KELLY'S RECTAL SPECULUM**

SMALL  
MEDIUM  
LARGE  
EXTRA LARGE



**KELLY'S RECTAL SPECULUM**

WITH FIBER OPTIC CARRIER  
SMALL  
MEDIUM  
LARGE  
EXTRA LARGE

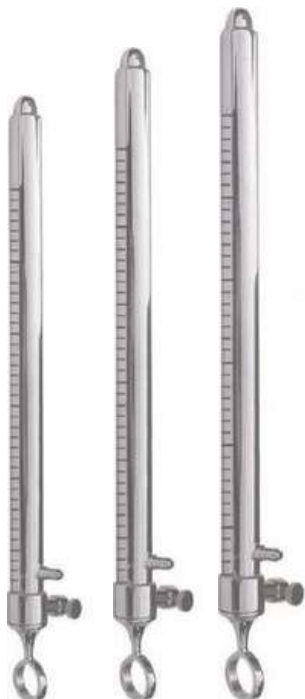

**SMALL**      **MEDIUM**      **LARGE**



**SIGMOID SCOPE WITH FIBER OPTIC LIGHT CARRIER**

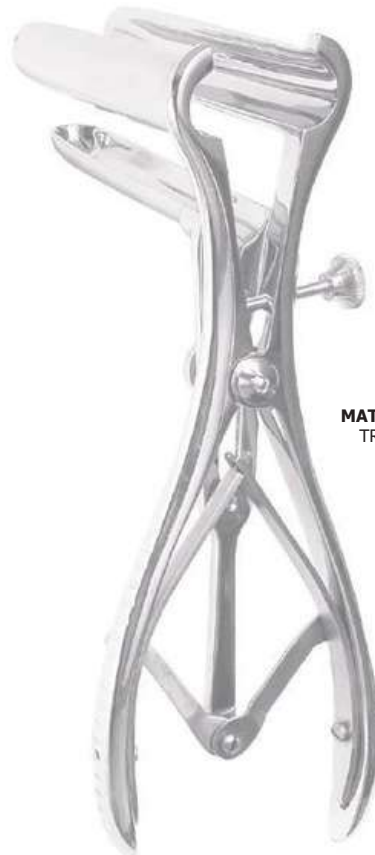

**MATHIEU RECTAL SPECULUM**

TRIVALVE SELF RETAINING

# RECTAL INSTRUMENTS



**HAEMORRHOIDAL  
LIGATING GUN**

**PILES BAND  
RUBBER**

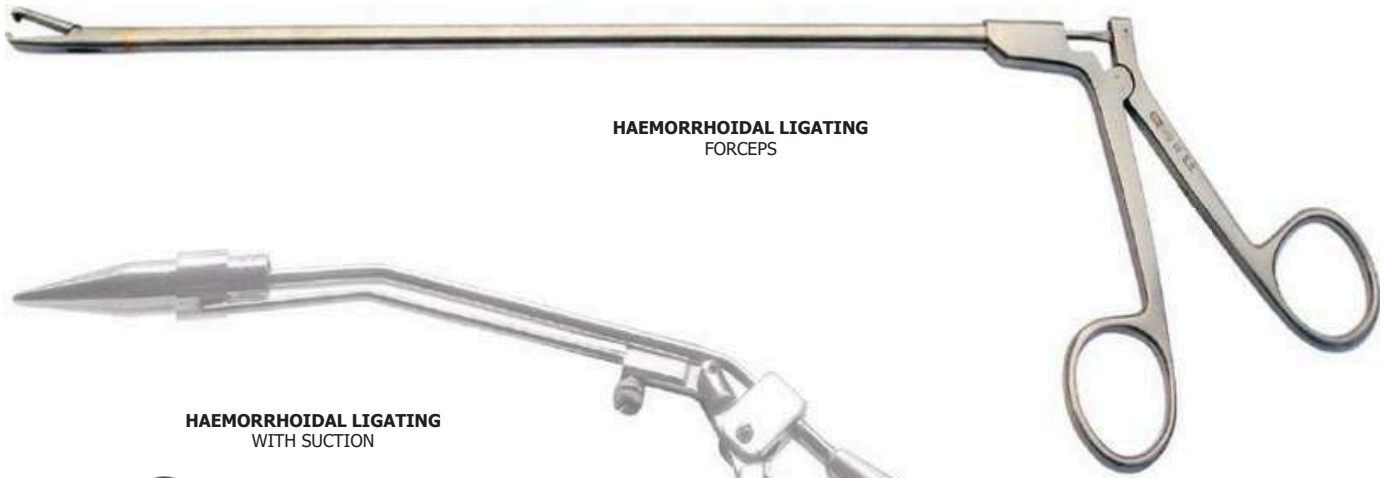

**HAEMORRHOIDAL LIGATING  
FORCEPS**



**HAEMORRHOIDAL LIGATING  
WITH SUCTION**



**ST. MARKS RECTAL DILATOR**

- NO.1
- NO.2
- NO.3
- NO.4

# GYNECOLOGY INSTRUMENTS



**UTERINE DRESSING  
FORCEPS**



**UTERINE TENACULUM  
SINGLE TOOTH FORCEPS**



**UTERINE VULSELLUM  
FORCEPS**



**UTERINE TENACULUM  
SINGLE TOOTH FORCEPS,**

# GYNECOLOGY INSTRUMENTS



**HOOK ,**  
10"-25.5 CM



**HOOK WITH 3 PRONGS ,**  
10"-25.5 CM



**KOGAN 9.5" (24CM)**  
CALIBRATED, TEFLON COATED

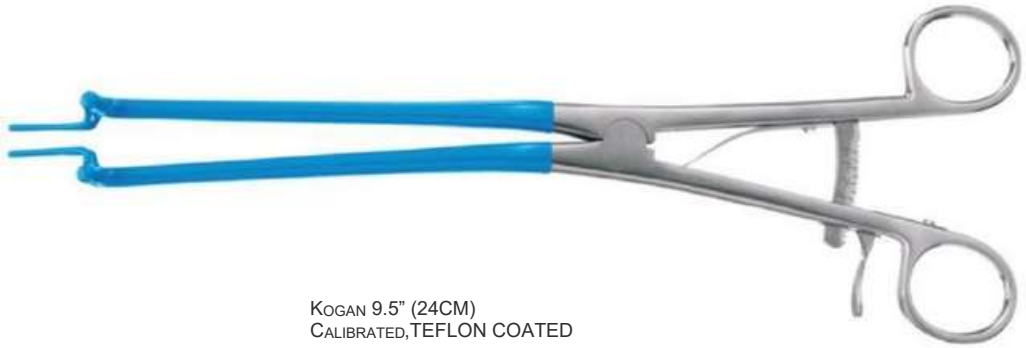

**UTERINE MANIPULATOR**  
RING HANDLE

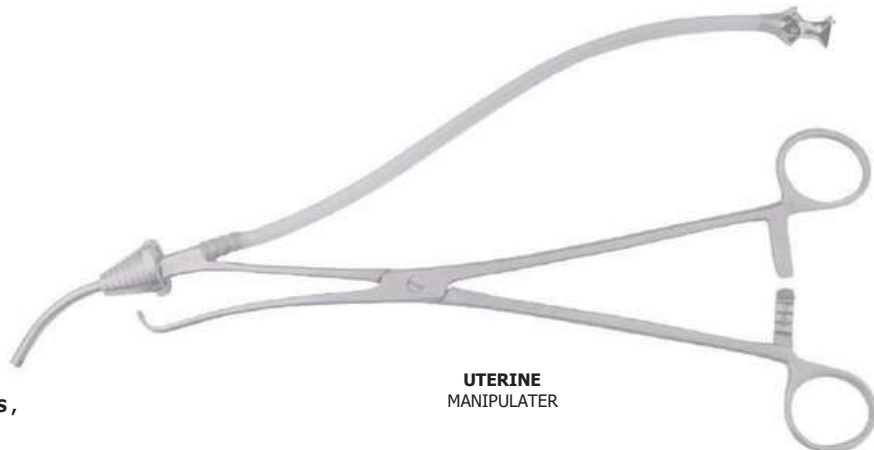

**UTERINE  
MANIPULATOR**

# GYNECOLOGY INSTRUMENTS



**COLLIN UTERINE  
ELEVATING FORCEPS**



**BURKE  
BIOPSY PUNCH, 8.5"**

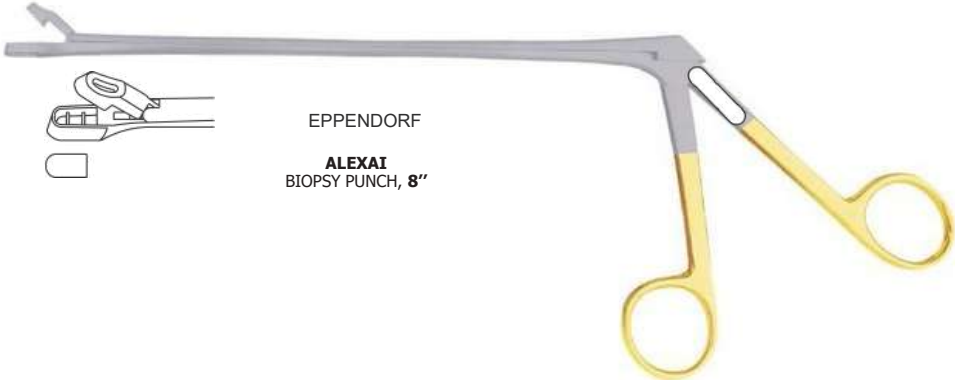

**EPPENDORF  
ALEXAI  
BIOPSY PUNCH, 8"**

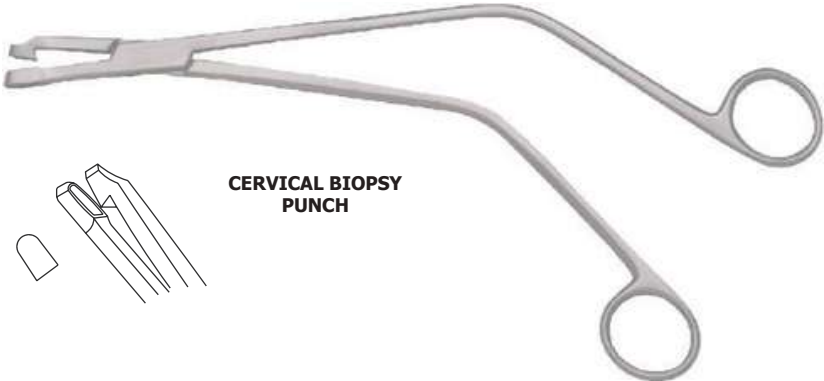

**CERVICAL BIOPSY  
PUNCH**

# GYNECOLOGY INSTRUMENTS



**LONDON  
VAGINAL RETRACTOR  
RIGHT ANGLED**



**MIDWIFERY FORCEPS  
SIMPSON**



**WRINGLE  
FORCEPS**

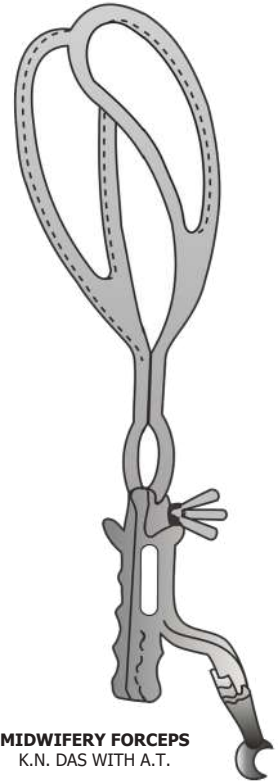

**MIDWIFERY FORCEPS  
K.N. DAS WITH A.T.**



**SIMS UTERINE CURETTE , SEMI SHARP 10"-25.5CM**



6MM



9MM



12MM

6MM

9MM

12MM



6X5MM

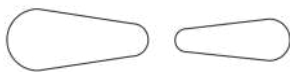

9X6MM



12X9MM

**SIMS UTERINE CURETTE , SEMI SHARP 10"-25.5CM  
DOUBLE ENDED**



**CUSCO**

SMALL 22X80MM  
MEDIUM 25X100MM  
LARGE 27X105MM

**CUSCO SPECULUM WITH FIBER**

SMALL 22X80MM  
MEDIUM 25X100MM  
LARGE 27X105MM

**GRAVES SPECULUM**

SMALL 20X75MM  
MEDIUM 35X95MM  
LARGE 35X115MM



**SIMS SPECULUM**

SMALL  
MEDIUM  
LARGE



**KRISTELLER VAGINAL  
SPECULUM**

SMALL  
MEDIUM  
LARGE



**GRAVES SPECULUM**

SMALL 20X75MM  
MEDIUM 35X95MM  
LARGE 35X115MM

# GYNECOLOGY INSTRUMENTS



SMALL



MEDIUM



LARGE  
7552



**HYSTO-GRAPHI CANNULAS**  
WITH LOCK



SMALL



MEDIUM



LARGE



**HYSTO-GRAPHI CANNULAS**  
WITHOUT LOCK



**ENDOMETRIAL BIOPSY CURETTE NOVAK**

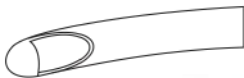

**RANDALLS ENDOMETRIAL BIOPSY CURETTE**



**GRADUATED UTERINE SOUND**

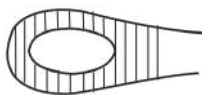

**INTERIOR VAGINAL WALL RETRACTOR**

# GYNECOLOGY INSTRUMENTS



**MYMO-SCREW**



**FOETAL**  
STETHOSCOPE

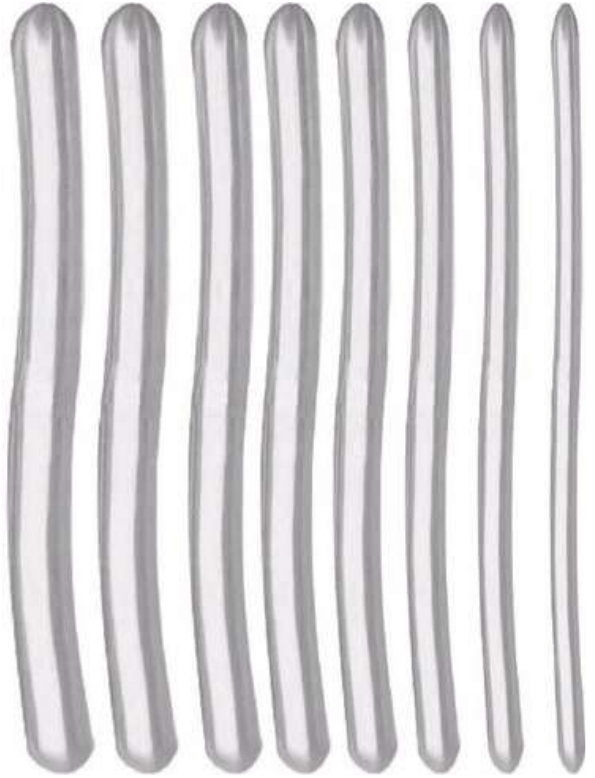

**HEGAR DILATORS**  
SET OF 8

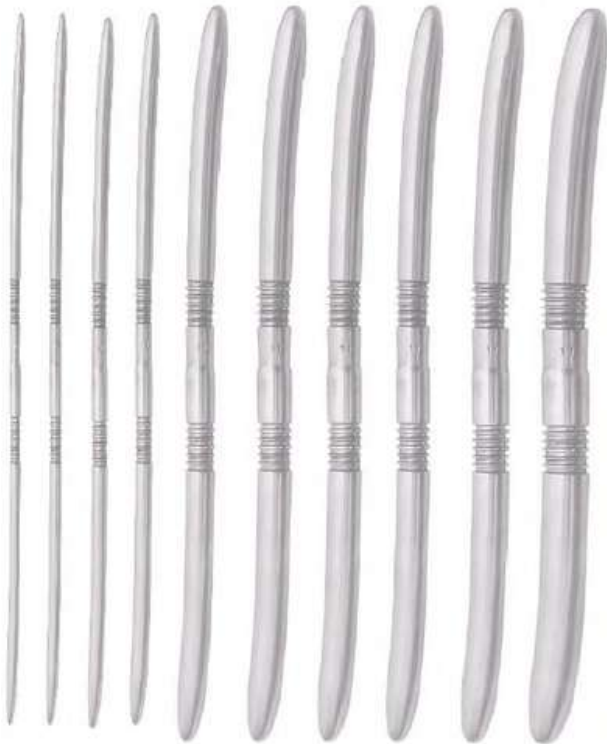

**HEGAR DILATORS**  
GRADUATED FINE 1/2MM  
SET OF 10



**HEGAR DILATORS**  
SINGLE ENDED  
SET OF 16

# ORTHO & NEURO INSTRUMENTS



<b>STRAIGHT</b>	<b>CURVED</b>
2mm	2mm
3mm	3mm
4mm	4mm
6mm	6mm
8mm	8mm
10mm	10mm

**GILLIES  
OSTEOTOME**



**STRAIGHT**  
2mm  
3mm  
4mm  
6mm  
8mm  
10mm

**GILLIES  
CHISEL**



**SIZE**  
2mm  
3mm  
4mm  
6mm  
8mm  
10mm

**GILLIES  
GOUGE**



**6MM  
8MM  
10MM  
12MM  
14MM  
18MM  
22MM**

**STILLE OSTEOTOME  
20cm 8" LENGTH**



**6mm  
9mm  
13mm  
16mm  
19mm  
25mm  
32mm**

**LAMBOTTE GOUGE  
25cm 9 3/4" LENGTH**





**LAMPERT CURETTE**  
STRAIGHT/ANGLED 21cm/8¼"

**SIZE**  
1.0mm  
1.5mm  
2.0mm  
2.5mm

**SIZE**  
3.0mm  
3.5mm  
4.0mm  
4.5mm

**SIZE**  
1.0mm  
1.5mm  
2.0mm  
2.5mm

**SIZE**  
3.0mm  
3.5mm  
4.0mm  
4.5mm

**VOLKMANN DOUBLE**

ENDEDCURETTE22CM

**SIZE**  
3MM/5MM  
4MM/6MM  
5MM/7MM



**TOFFEE MALLET**

24.5cm , 200GRAM  
30mm WITHINTERCHANGEABLE  
PLASTIC DISC



**MALLET WIH FERROZELL  
HANDLE**



**PERCUSSOR HAMMER  
T-SHAPE**



**PERCUSSOR HAMMER**



# ORTHO & NEURO INSTRUMENTS

**WIRE CUTTER**

19 cm – 7 1/2” 23 cm – 9”



T.C



T.C



**HENNING SOREDER**  
 27CM-10 3/4'



for twist drills up to Ø 7 mm,  
 for wires up to Ø4 mm

Ralk



Engel  
 Plaster saw  
 15 cm – 6”



Satterlee  
 29 cm – 11 3/8”

# ORTHO & NEURO INSTRUMENTS



Liston



14 cm – 5 1/2?



17 cm – 6 3/4?



20 cm – 8?



22 cm – 8 3/4?



15 cm – 6?



14 cm – 5 1/2?



17 cm – 6 3/4?



20 cm – 8?



22 cm – 8 3/4?



Liston-mini



15 cm – 6?

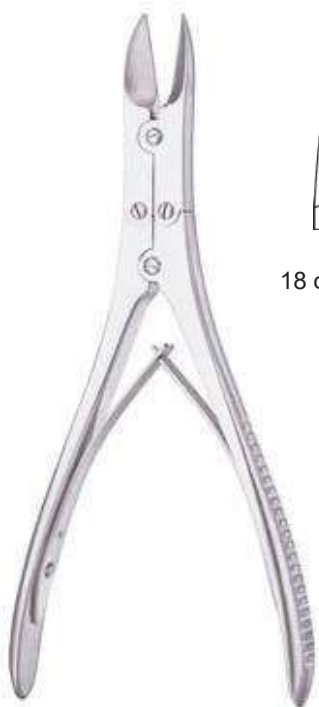

Ruskin-Rowland



18 cm – 7 1/8?



18 cm – 7 1/8?



McIndoe



18 cm – 7 1/8?



18 cm – 7 1/8?

# ORTHO & NEURO INSTRUMENTS

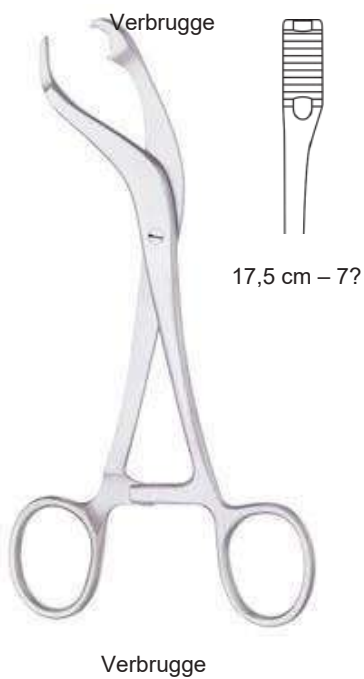
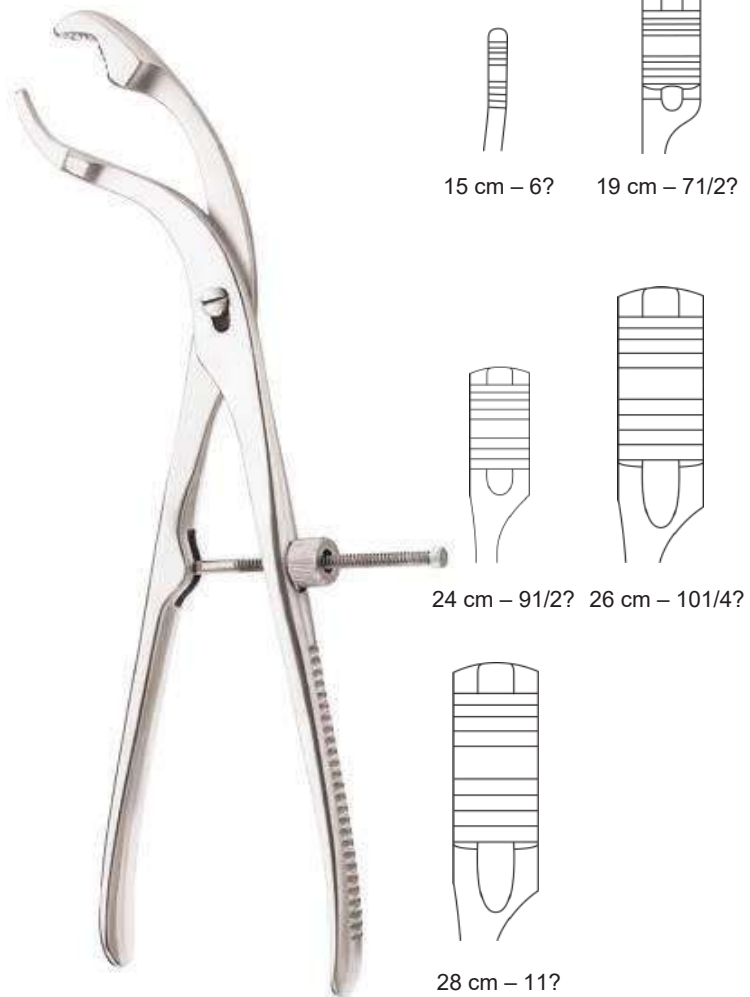

# ORTHO & NEURO INSTRUMENTS



**HYGIENIC LUMBAR AND CERVICAL  
KERRISON LAMINECTOMY  
RONGEURS**



# CARDIOLOGY INSTRUMENTS

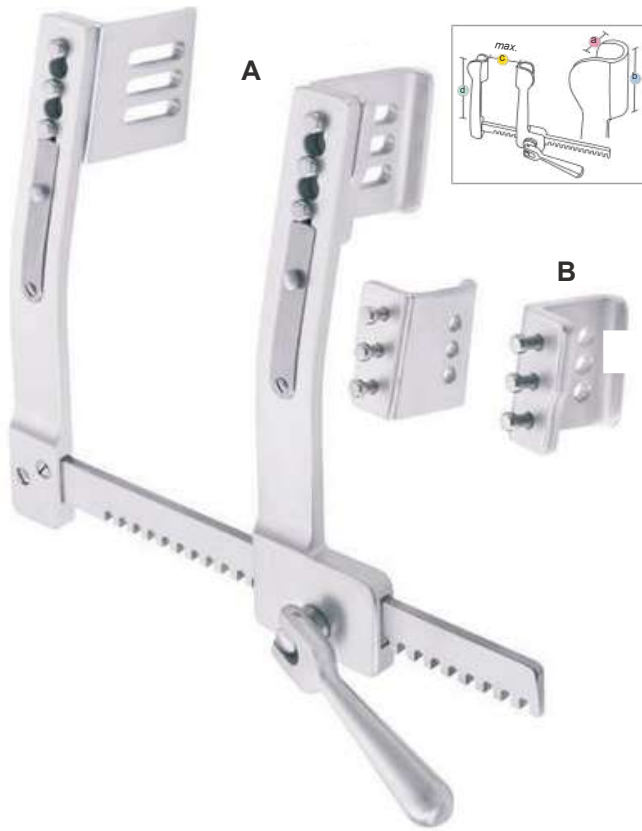

Burford  
with **2 pairs** of detachable blades

a	b	c	d
mm	mm	mm	mm

stainless steel	A B	63 43	61 61	260	200	for adults
-----------------	--------	----------	----------	-----	-----	------------

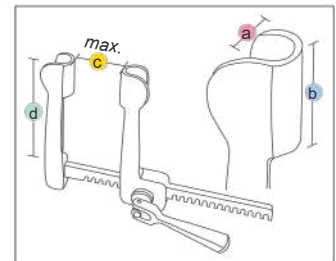

a	b	c	d
mm	mm	mm	mm

stainless steel	40 50 60	100 80 60	200	185	
-----------------	----------------	-----------------	-----	-----	--

DeBakey  
with **3 pairs** of detachable blades

# CARDIOLOGY INSTRUMENTS

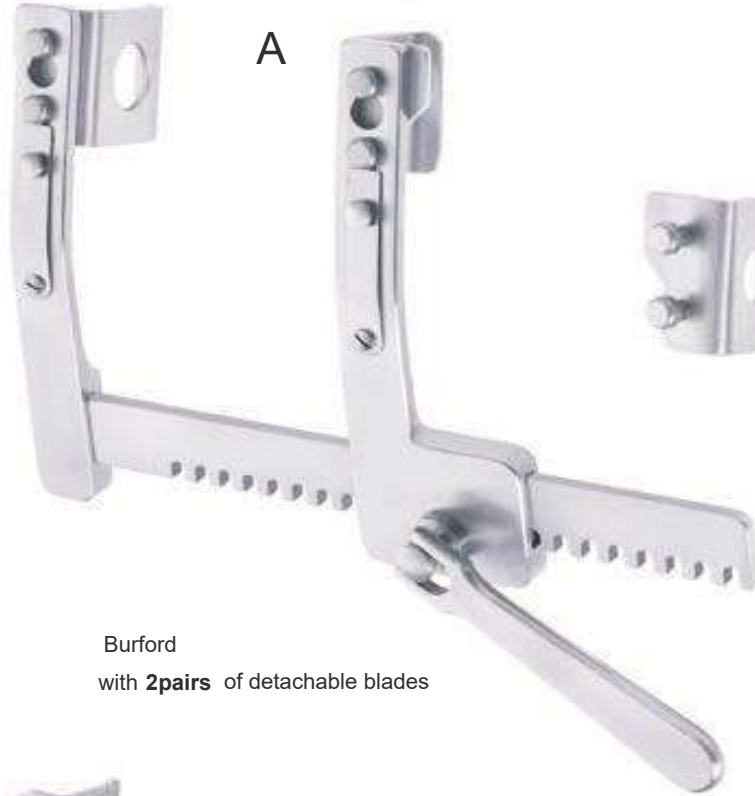

A

B

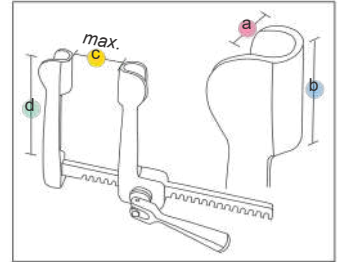

		a	b	c	d	
		mm	mm	mm	mm	
stainless steel	A	40	42	130	117	for children
	B	30	42			

Burford  
with **2pairs** of detachable blades

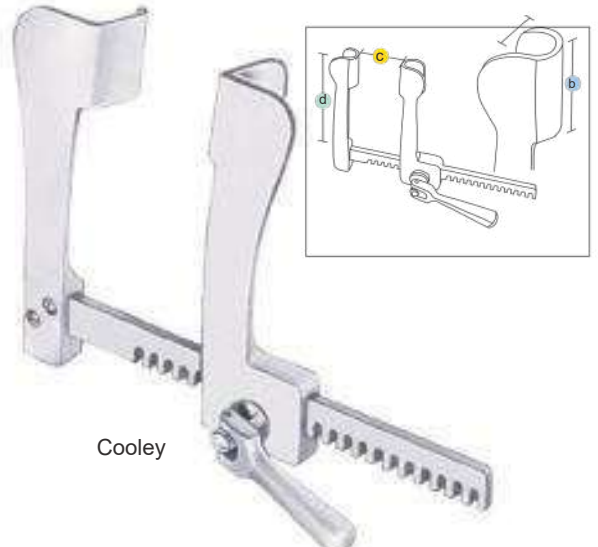
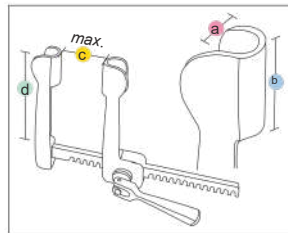
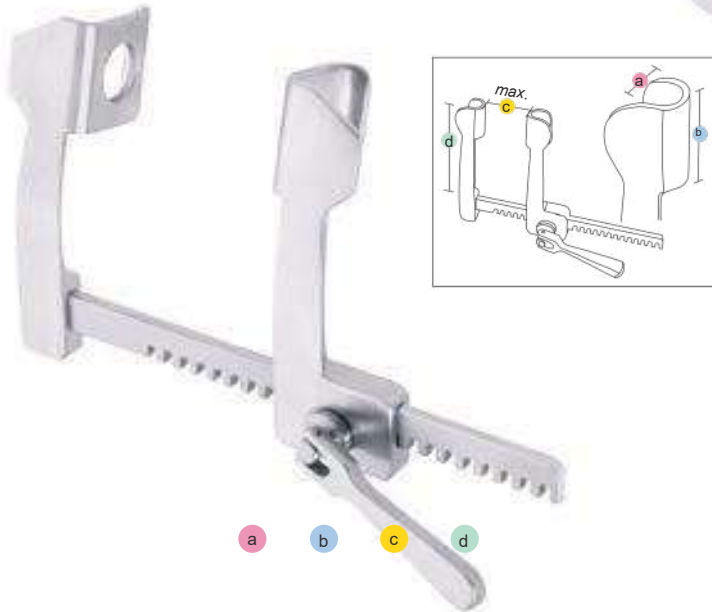

Cooley

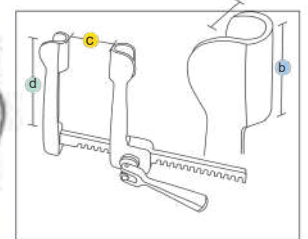

	a	b	c	d	
	mm	mm	mm	mm	
stainless steel	28	30	100	75	for children
stainless steel	12	15	70	55	for babies

		a	b	c	d	
		mm	mm	mm	mm	
stainless steel	20	24	100	80	for babies	

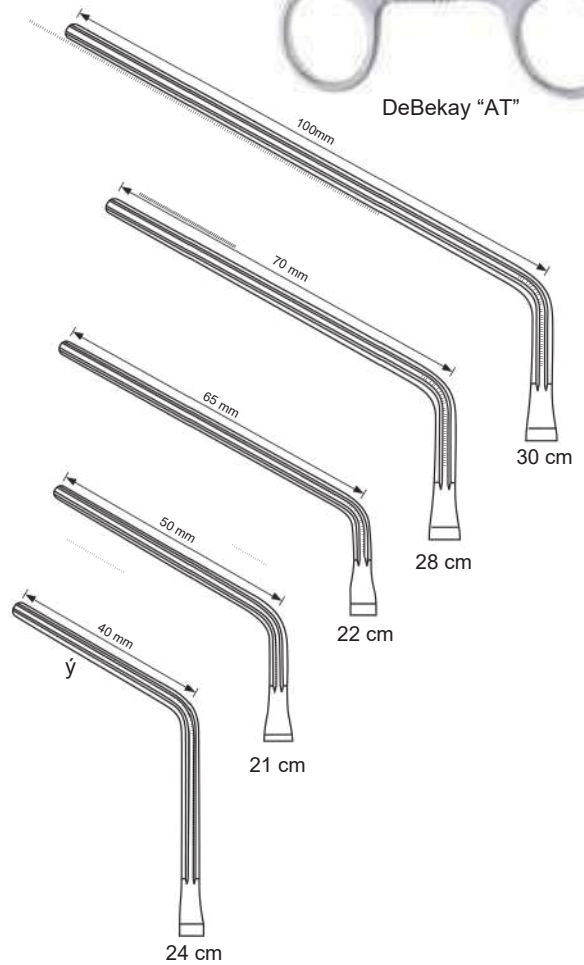
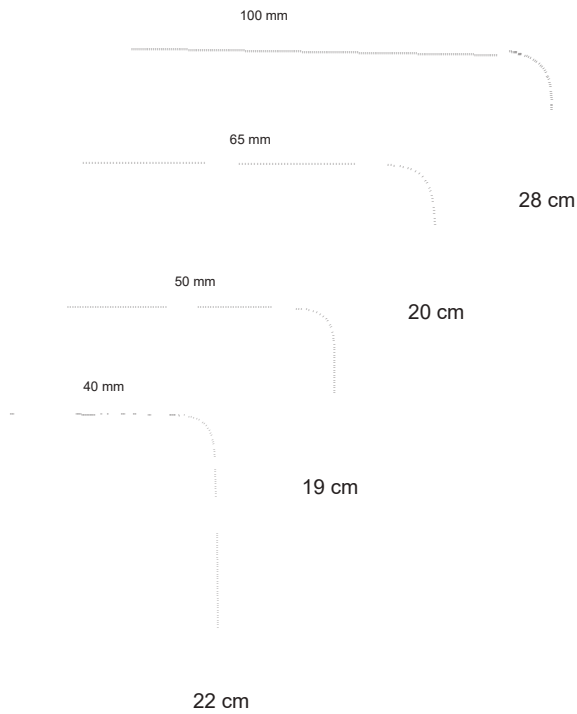

# CARDIOLOGY INSTRUMENTS

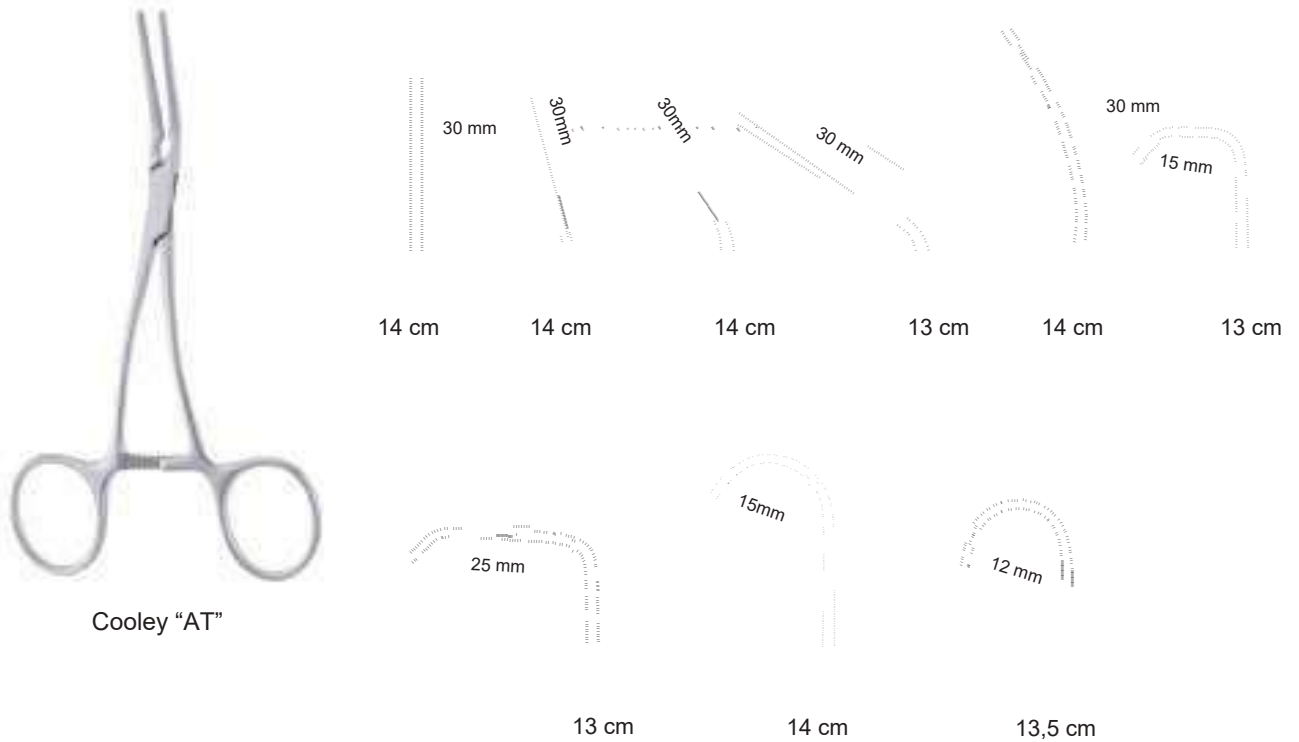
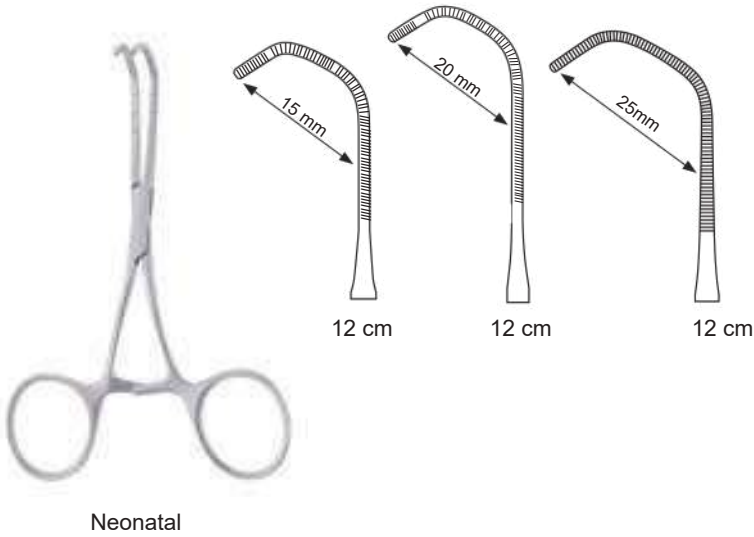



# CARDIOLOGY INSTRUMENTS



Duval

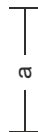

**ALLISON LUNG**  
RETRACTOR



**RIB SPREADERS**  
APPROXIMATOR

DeBakey Vessel Dilator  
19cm/ 7 1/2" Length  
Malleable Shaft

Diameter Ø

- 0.5mm
- 1.0mm
- 1.5mm
- 2.0mm
- 2.5mm
- 3.0mm



Diameter Ø

- 3.5mm
- 4.0mm
- 4.5mm
- 5.0mm
- 7.0mm
- 9.0mm



# GENERAL INSTRUMENTS



**LANES TWIN**  
INTESTINAL CLAMPS  
CURVED

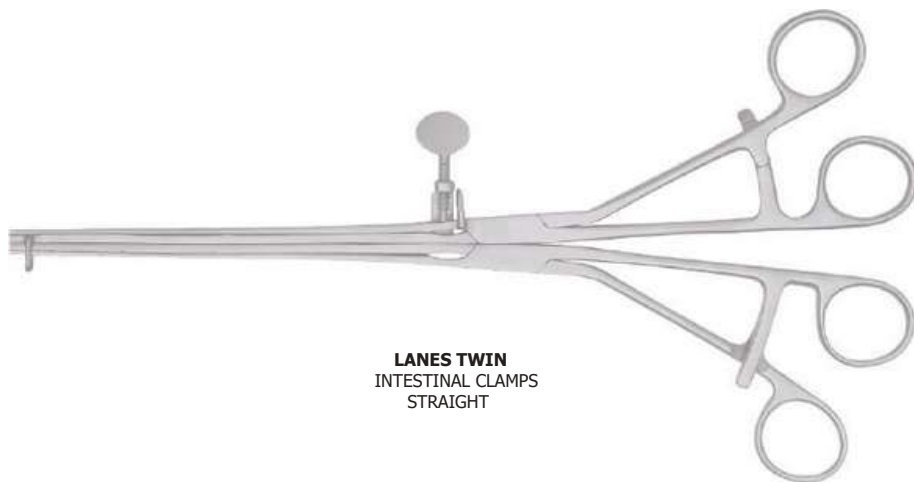

**LANES TWIN**  
INTESTINAL CLAMPS  
STRAIGHT



**145MM**



**110MM**



**70MM**



**PAYRS CRUSHING**  
INTESTINAL CLAMP

# GENERAL INSTRUMENTS



**BLADDER  
NECK SPREADER**



**SUPRAPUBIC TROCARS  
& CANNULA**

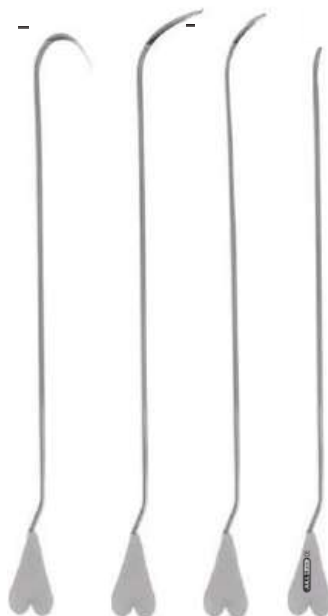

**FISTULA DIRECTORS**

- NO.1
- NO.2
- NO.3
- NO.4



**CATHETER INTRODUCER**



**LISTER UREATHAL DILATOR  
SET OF 12**



**CLUTTON UREATHAL  
DILATOR SET OF 12**



**MALE CATHETER  
SET OF 10**



**CATHETER**

# NEEDLES

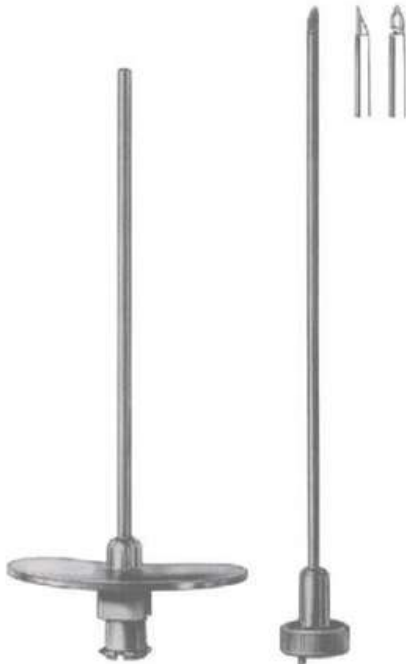

**MEGHINI RENAL BIOPSY NEEDLE**



**SILVER BIOPSY NEEDLE**



**PILE SYRINGE NEEDLE STRAIGHT**



**PILE SYRINGE NEEDLE CURVED**



**SPINAL (LP) NEEDLE**

12  
14  
16  
18  
20  
22  
24



**LUER LOCK**



**LICHTWITZ**  
Ø 1,5 mm  
Ø 1,8 mm  
Ø 2,0 mm



**LICHTWITZ-EICKEN**  
Ø 1,5 mm  
Ø 1,8 mm  
Ø 2,0 mm

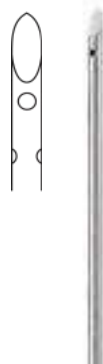

**VOGEL**  
Ø 1,5 mm  
Ø 1,8 mm  
Ø 2,0 mm



**BONE MARROW trephine needle**  
16  
18  
20



**STERNAL Ø 1.8 mm PUNCTURE NEEDLE**

# SUCTIONS

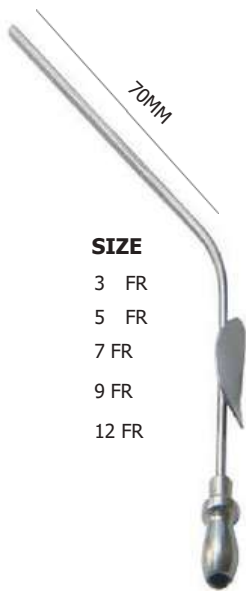

- SIZE**
- 3 FR
  - 5 FR
  - 7 FR
  - 9 FR
  - 12 FR

**BARRON SUCTION  
TUBE**

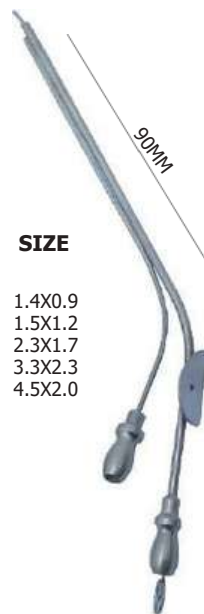

- SIZE**
- 1.4X0.9
  - 1.5X1.2
  - 2.3X1.7
  - 3.3X2.3
  - 4.5X2.0

**SUCTION IRRIGATION TUBE  
WITH CHANNEL**

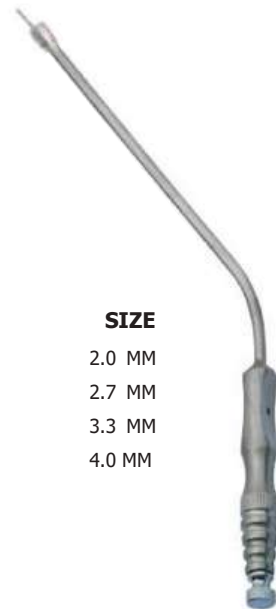

- SIZE**
- 2.0 MM
  - 2.7 MM
  - 3.3 MM
  - 4.0 MM

**FRAZIER SUCTION  
TUBES, BALL END, L-8"**

# BLADES & HANDLES



**LONG HANDLE**  
B.P. Handle 3



**LONG HANDLE**  
B.P. Handle 4



B.P. Handle 7



ROUND. Handle 3



B.P. Handle Curved



VERTICAL CUTTING  
HORIZONTAL CUTTING  
VERTICAL CUTTING



ROUND HANDLE  
NO-3  
NO-4



No.10



No.11



No.12



No.15



No.21



No.23

# BLADES & HANDLES



**WATSON SKIN**  
GRAFTING HANDLE



**HUMBY SKIN**  
GRAFTING HANDLE



**SKIN GRAFTING**  
BLADE



**SILVER SKIN**  
GRAFTING KNIFE  
FOR SAVING BLADES USE

# BIPOLAR INSTRUMENTS



16 cm  
19.5 cm  
B-15141 25 cm  
**BIPOLAR COAGULATION**  
FORCEPS BAYONET TIP-1MM



16 cm  
19.5 cm  
**BIPOLAR**  
**COAGULATION**  
FORCEPS BAYONET TIP-1MM



16 cm  
19.5 cm  
**BIPOLAR**  
**COAGULATION**  
FORCEPS BAYONET TIP-1MM  
WITH SUCTION



16 cm  
19.5 cm  
**BIPOLAR**  
**COAGULATION** TIP-1MM  
FORCEPS (ST.)



16 cm  
19.5 cm  
**BIPOLAR**  
**COAGULATION** TIP-1MM  
FORCEPS (ST.)



16 cm  
19.5 cm  
**BIPOLAR**  
**COAGULATION**  
FORCEPS CURVED TIP-1MM



16 cm  
19.5 cm  
**BIPOLAR COAGULATION**  
FORCEPS CURVED  
WITH TWO PINS TIP-1MM



16 cm  
19.5 cm  
**BIPOLAR**  
**COAGULATION**  
FORCEPS CURVED TIP-1MM



16 cm  
19.5 cm  
**BIPOLAR**  
**COAGULATION**  
FORCEPS CURVED TIP-1MM  
WITH SUCTION



16 cm  
19.5 cm  
**BIPOLAR**  
**COAGULATION**  
FORCEPS CURVED TIP-1MM  
WITH TWO PINS

# BIPOLAR INSTRUMENTS



19.5 cm  
25cm

**BIPOLAR COAGULATION**  
FORCEPS BAYONET TIP-1MM



19.5 cm

**BIPOLAR COAGULATION**

FORCEPS BAYONET TIP-1MM



19.5 cm

**BIPOLAR COAGULATION**

FORCEPS BAYONET TYPE TIP-1MM WITH SUCTION



16 cm  
19.5 cm

**BIPOLAR COAGULATION**  
FORCEPS (ST.) TIP-1MM



16 cm  
19.5 cm

**BIPOLAR COAGULATION**  
FORCEPS (ST.) TIP-1MM



16 cm  
19.5 cm

**BIPOLAR COAGULATION**  
FORCEPS CURVED TIP-1MM



16 cm  
19.5 cm

**BIPOLAR COAGULATION**  
FORCEPS CURVED TIP-1MM WITH TWO PINS



16 cm  
19.5 cm

**BIPOLAR COAGULATION**  
FORCEPS CURVED TIP-1MM



16 cm  
19.5 cm

**BIPOLAR COAGULATION**  
FORCEPS CURVED TIP-1MM WITH SUCTION



19.5 cm  
**BIPOLAR COAGULATION**  
FORCEPS CURVED TIP-1MM WITH TWO PINS

# BIPOLAR INSTRUMENTS



**BALL PROBE**  
WORKING LENGTH- 140MM  
3MM  
5MM



**NEEDLE**  
WORKING LENGTH - 35MM



**MONOPOLAR CABLE**



**CABLE**



**LOOPS**  
WORKING LENGTH- 140MM  
1.5X1.5MM  
2.0X1.5MM  
2.0X1.5MM  
2.0X2.0MM



**PENCIL CABLE**



**BIPOLAR CABLE Double PIN**



**BIPOLAR CABLE FLAT PIN**



**BIPOLAR CABLE TWO PIN**



**ARTERY FORCEPS STRAIGHT**  
7"



**ARTERY FORCEPS CURVED**  
7"



**TURNER WARWICK SCISSORS STRAIGHT**  
7"



**TURNER WARWICK SCISSORS CURVED**  
7"



**Bipolar Clamp**

# LARYNGOSCOPE



**FIBER OPTIC  
FLEXIBLE LARYNGOSCOPE  
SET OF 3**



**FIBEROPTIC LARYNGOSCOPE  
SET OF 3**



**MAGILL LARYNGOSCOPE  
WITH BLADES**  
SET OF 2 BLADES  
SET OF 3 BLADES  
SET OF 4 BLADES



**LAMP FOR LARYNGOSCOPE**



**McINTOSH LARYNGOSCOPE  
WITH BLADES**  
SET OF 3 BLADES  
SET OF 4 BLADES



**SURGICAL CRYO**  
WITH ONE PROBE



**BREATHING BAG**  
PEDIATRIC  
SILICONE



**BREATHING BAG**  
CHILD  
SILICONE



**BREATHING BAG**  
ADULT  
SILICONE



**TOURNIQUET WITH PUMPS**  
ALONG WITH 3 CUPS  
COVERED WITH CLOTH BAG



# HOLLOWWARE



SPUTUM CUP  
STAINLESS STEEL



SWAB BOX  
STAINLESS STEEL



BOWL  
STAINLESS STEEL

3"  
4"  
5"  
6"  
8"



BED PANS  
STAINLESS STEEL  
MALE  
FEMALE



BASINS  
STAINLESS STEEL

7448 10"  
7449 12"  
7450 14"



DRESSING DRUMS  
HEAVY DUTY STAINLESS STEEL

6" x 6"  
9" x 5"  
9" x 9"  
9" x 11"  
11" x 5"  
12" x 10"  
14" x 9"  
14" x 12"  
15" x 12"



PORTABLE SINGLE DRUM  
AUTOCLAVE HEAVY DUTY  
STAINLESS STEEL

12" X 12"

# TRAYS



**INSTRUMENTS STERILIZING  
PERFORATOR BOX**  
STAINLESS STEEL  
8" x 4" x 2"  
11" x 7" x 2"  
12" x 10" x 3"  
14" x 10" x 2"



**AUTOClave INSTRUMENT BOX**  
WITH SILICONE MATT  
STAINLESS STEEL  
8" x 4" x 1"  
9" x 8" x 1"  
14" x 8" x 1"



**CIDEX BOX HEAVY**  
STAINLESS STEEL  
2 8" x 6" x 5"



**SURGICAL TRAY WITH LID**  
HEAVY STAINLESS STEEL  
6" x 9"  
7" x 11"  
8" x 10"  
10" x 12"  
12" x 15"



**KIDNEY TRAY  
HEAVY**  
STAINLESS STEEL  
6"  
8"  
10"  
12"



**MEASURING BOWL**

# SUCTION & LIGHT SOURCE



**SUCTION MACHINE**  
HI - VAC 4.5 LTRS  
(50x38x70)CMS



**SUCTION MACHINE**  
JUNIOR HI - VAC 3.0 LTRS  
(39x33x65)CMS



**SUCTION MACHINE**  
EP-90 ELECTRIC CUM MANUAL



**ULTRA COMPACT**  
XENON LIGHT SOURCE 300W



**FIBER OPTIC CABLE**  
3.5 mm length 230 cm  
4.5 mm length 230 cm



**LED LIGHT SOURCE**



**FIBER OPTIC COLD LIGHT SOURCE**  
DOUBLE POINT 24 V - 250 W



**FIBER OPTIC COLD LIGHT SOURCE**  
SINGLEPOINT 15V - 150W



# HEALTHCORE

## VENTURES

**build.scale.expand.**

Unit no 157, Kaliandas Udyog Bhavan, near Century Bazar, Prabhadevi, Mumbai- 400025

**Tel:** +91 86554 11521

**Email:** [sales@healthcoreventures.com](mailto:sales@healthcoreventures.com)

**Web:** [www.healthcoreventures.com](http://www.healthcoreventures.com)