



PRODUCT CATALOGUE

Orthopedic Surgical Instruments

INDEX

DHPS Instrumentation
Mini Fragment Instrumentation
Small Fragment Instrumentation
Large Fragment Instrumentation
Pelvic Instrumentation
Instrumentation for Cannulated Screw
Instrumentation for Cannulated Screw 4.5mm
Instrumentation for Cannulated Screw 7mm
Shoulder Surgery Instruments
HIP Revision Instruments
Bone File
Elevator
Raspatories
Chisels , Gouges , Osteotome
Hammer
Curettes
Bone Nibblers & Rongeurs
Bone Cutter
Bone Holding Forceps
Reamers
Bone Levers
Screwdriver & Inserter
K-Wire & Guides
Nose Pliers & Cutters
Saws
Plaster Spreader & Scissors
Hand Drills & Accessories
Kerrison Punch & Rongeurs
Retractor
Needle Holder
Micro & General Scissors
Micro & General Dissecting Forceps
Blades & Handles
Bipolar Instruments
General Instruments
Suction



Drill guide adjustable



Drill guides



Drill guide
for supracondylar plates
95°

- 130°
- 135°
- 140°
- 145°
- 150°



Three-step reamer

for standard DHPS plates



Three-step reamer

for supra condylar DHPS plates

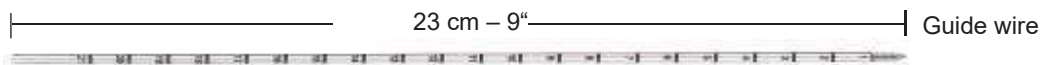

Guide wire

2,5 mm

DHPS INSTRUMENTATION

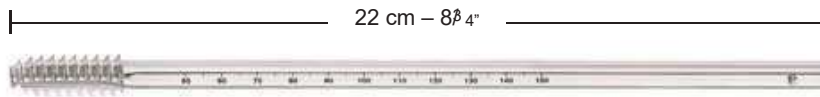

Tap 12,5 mm



Centering sleeve, short



T-Handle, large, with quick coupling



Centering sleeve, long

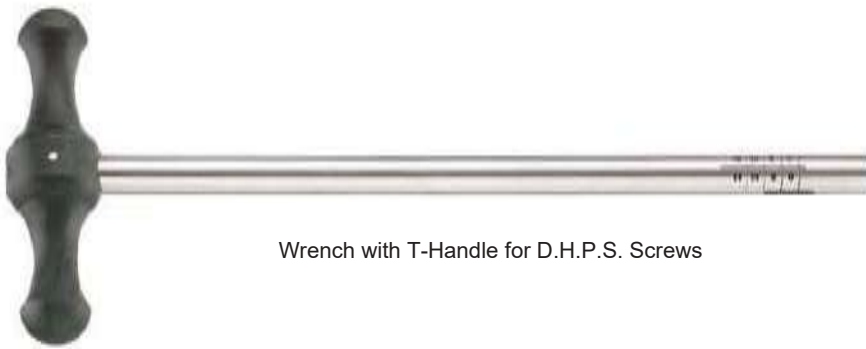

Wrench with T-Handle for D.H.P.S. Screws



Coupling screw, long



Coupling screw, short



Guide Shaft



Mpactor



for Calibrated screws



Taps for Cortical Screws

4,5 mm
6,5 mm



Drills with quick coupling

100mm	2,0 mm
145mm	3,2 mm
145mm	4,5 mm



Double Drill Sleeve



Ø 6,5 mm Ø 3,2 mm



T-Handle, small, with quick coupling



Universal drill sleeve



Ø 4,5 mm Ø 3,2 mm

3,5 mm



Screwdriver Hexagonal
24,5 cm - 9

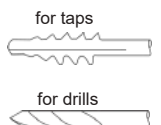

Holding sleeve
for screws



Screw Holding Forceps



Depth Gauge Large
for screws Ø 4,5 / 6,5 mm

MINI FRAGMENT INSTRUMENTATION



Screwdriver Handle
with dental coupling



Screwdriver insert hexagonal
for dental coupling



Screwdriver Handle
with dental coupling



for 1.5mm
Screwdriver hexagonal 18 cm - 7/16"



Holding sleeve for screws
for screws Ø 1,5 / 2,0 mm

For Screws 2.7mm



Handle
with quick coupling



Screwdriver insert hexagonal- 100mm
for quick coupling



Screwdriver insert hexagonal- 135 mm
for quick coupling



Holding sleeve for screws
for screws Ø 2,7 mm



2,5 mm

Screwdriver hexagonal 20 cm - 8"

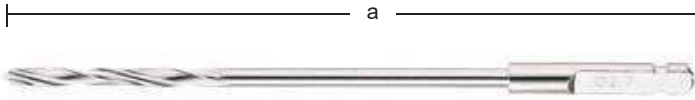

Holding sleeve for screws
for screws Ø 2,7 mm



Drills for Quick Coupling

a	Ø
60 mm	1.1mm
85 mm	1.5mm
110 mm	1.5mm
100 mm	2.0mm
125mm	2.0mm
100mm	2.7mm
125mm	2.7mm

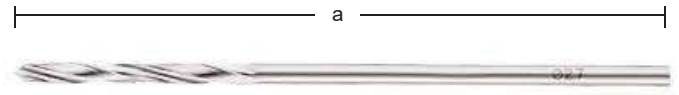

Drills for three-jaw chuck

45mm	1.1mm
70mm	1.5mm
85mm	2.7mm

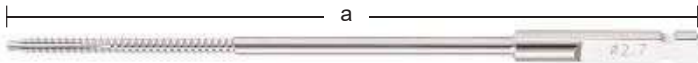

Taps for quick coupling for cortical screws

a	Ø
60mm	1.5mm
70mm	2.0mm
100mm	2.7mm

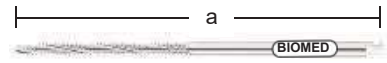

Taps for dental coupling for cortical screws

a	Ø
50mm	1.5mm
53mm	2.0mm



Countersink for quick coupling
for screws Ø 1,5 / 2,0 mm 60mm

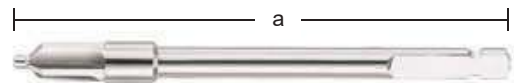

Countersink for quick coupling
for screws Ø 2,7 / 3,5 / 4,0 mm72mm

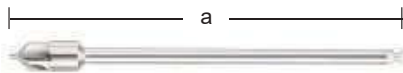

Countersink for dental coupling
for screws Ø 1,5 / 2,0 mm 57mm



Double drill sleeves



1.5mm	1.1mm
2.0mm	1.5mm
2.7mm	2.0mm



Parallel drill sleeve

2.0mm



Drill sleeve neutral and excentric
for screws 2.7mm



2.0mm



for taps

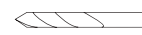

para brocas

MINI FRAGMENT INSTRUMENTATION



Screwdriver Handle
with dental coupling



Screwdriver Handle
with dental coupling



Handle
with quick coupling



Screwdriver insert hexagonal
for dental coupling

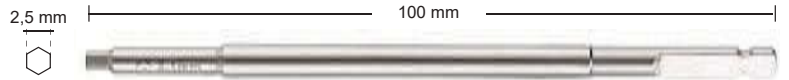

Screwdriver insert hexagonal
for quick coupling



Screwdriver hexagonal 18 cm - 7 1/8"



Screwdriver hexagonal 20 cm - 8"



Holding sleeve for screws
for screws Ø 1,5 / 2,0 mm



Holding sleeve for screws
for screws Ø 2,7 mm



Holding sleeve for screws
for screws Ø 2,7 mm



Depth gauge, Mini
for screws Ø 1,5 / 2,0 mm



Depth gauge, small
for screws Ø 2,7 mm



Bending Lever for Plates 1,5 and 2,0 mm



Bending lever for plates 2,7 mm
Right



Bending bolt
for Kirschner wires



Bending lever for plates 2,7 mm
Left



Flat nose pliers 14 cm - 5 1/2"



Bending Pliers for Mini Plates
14 cm - 5 1/2"



Screw Holding Forceps

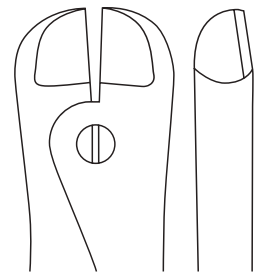
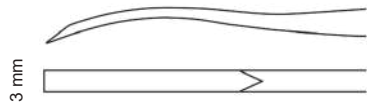

Plate and wire cutting forceps
19 cm - 7 1/2" 0 mm



Cleaning hook 16 cm - 6 1/4"



Raspatory 18,5 cm - 7 1/4"

MINI FRAGMENT INSTRUMENTATION

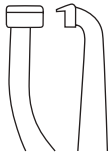

Holding Forceps for Small Plates
13,5 cm - 53/8"

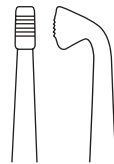

Holding Forceps for Fnger Plates
13,5 cm - 53/8"



Reposition Forceps Broad
13 cm - 51/8"

Bone Lever

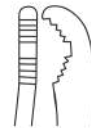

Bone Holding Forceps, Self-Centering
15cm - 6"

6 mm

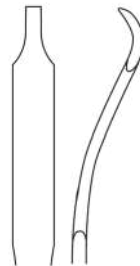

16 cm - 61/4"

8 mm

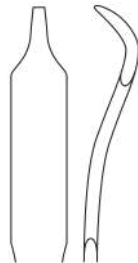

16 cm - 61/4?"

Bone Lever

15 mm

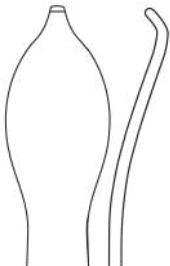

16 cm - 61/4"

Bone Lever Elevator per Ossa

SMALL FRAGMENT INSTRUMENTATION

Overview screwdrivers, blades and holding sleeves for screws

For Cortical Screws 3.5mm and Spongiosa Screws 4,0 mm



T-Handle, small, with quick coupling

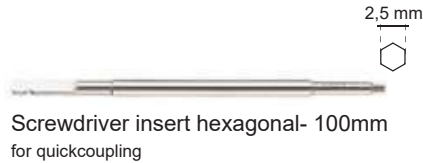

Screwdriver insert hexagonal- 100mm for quickcoupling

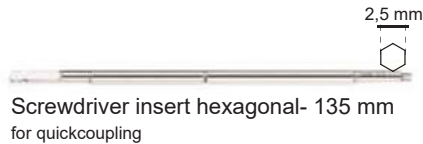

Screwdriver insert hexagonal- 135 mm for quickcoupling



Holding sleeve for screws for screws Ø 2,7 mm



2,5 mm
Screwdriver hexagonal 20 cm - 8"



Holding sleeve for screws for screws Ø 2,7 mm

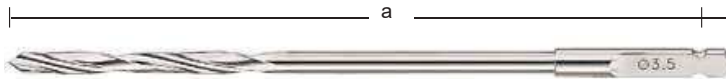

Drills for quick coupling

110 mm	2,5 mm
180 mm	2,5 mm
110 mm	3,5 mm
145 mm	3,5 mm
195 mm	3,5 mm

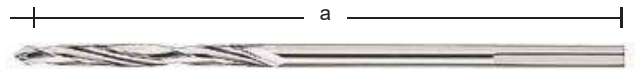

Drills for three-jaw chuck

95 mm	2,5 mm
95 mm	3,5 mm
180 mm	3,5 mm

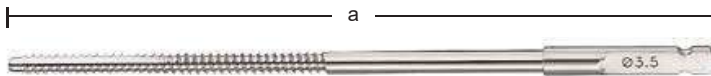

Tap or Quick Coupling for Cortical Screws

110 mm	3,5 mm
--------	--------



Taps for quick coupling for spongiosa screws

110 mm	3,5 mm
110 mm	4,0 mm

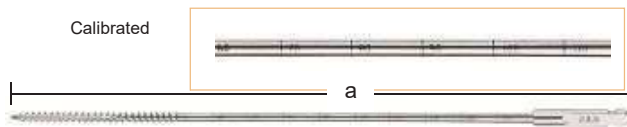

Tap for quick coupling for cortical screws

175 mm	3,5 mm
--------	--------

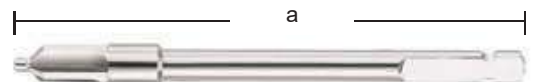

Countersink for quick coupling for screws Ø 3,5 / 4,0 mm

OR-7093031 72 mm

SMALL FRAGMENT INSTRUMENTATION

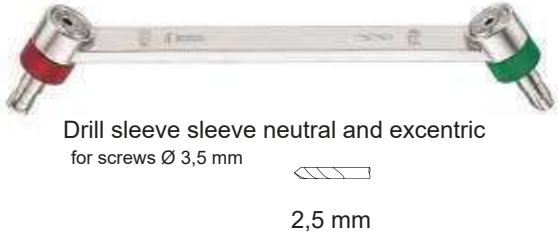

Combination Wrench 11 mm



T-Handle, small, with quick coupling

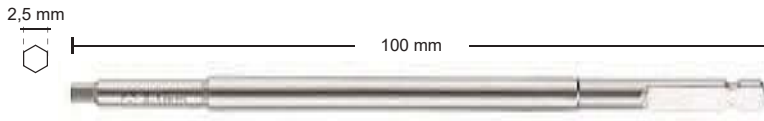

Screwdriver insert hexagonal for quick coupling



Holding sleeve for screws
for screws Ø 2.7



Screwdriver hexagonal 20 cm 8"



Screw holding forceps



Holding sleeve for screws for screws



Bending bolt for Kirschner wires up to 2,7 mm



Depth gauge, small for screws Ø 3,5 / 4,0 mm



Bending lever for plates 1,5 and 2,0 mm



Bending lever for plates 2,7 mm
right



Flat nose pliers 14 cm - 5 1/2"



Bending lever for plates 2,7 mm
left

SMALL FRAGMENT INSTRUMENTATION



Bone Holding Forceps
13,5 cm - 53/8"

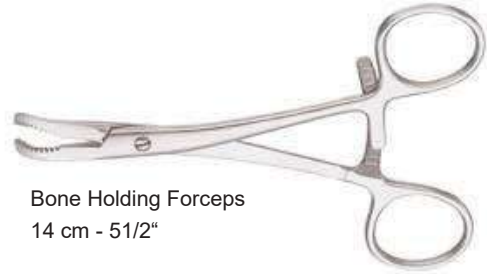
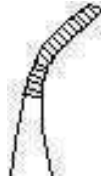

Bone Holding Forceps
14 cm - 51/2"



Cleaning Hook 61/4"



Raspatory 18,5 cm - 7 1/4"
6 mm

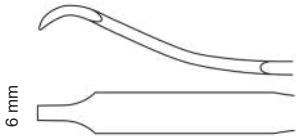
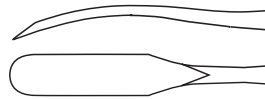

6 mm

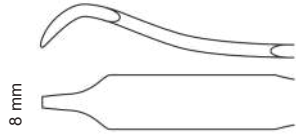

8 mm



16 cm - 6 1/4"

Bone Lever



Bone holding forceps, self-centering

Verbrugge

19 cm - 7 1/2"

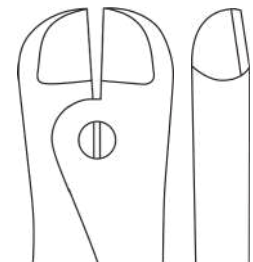
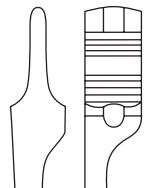

6 mm

Plate and Wire Cutting Forceps

19 cm - 7 1/2"

2,0 mm

LARGE FRAGMENT INSTRUMENTATION

Overview screwdrivers, blades and holding sleeves for screws

For Cortical Screws 4.5mm Spongiosa Screws 6.5mm and Malleolar Screws 4.5mm

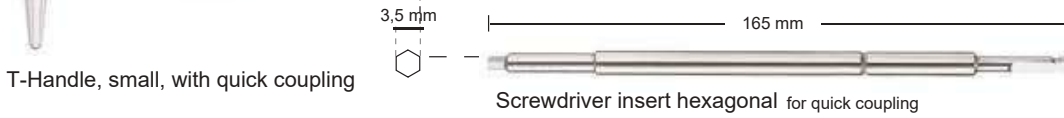
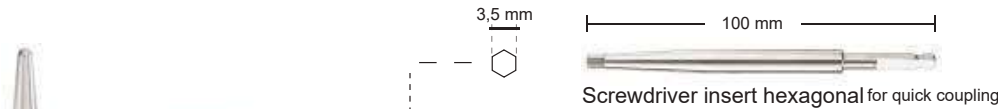

T-Handle, small, with quick coupling

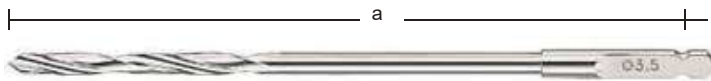

Drills for quick coupling

145 mm	3,2 mm
195 mm	3,2 mm
145 mm	4,5 mm
195 mm	4,5 mm

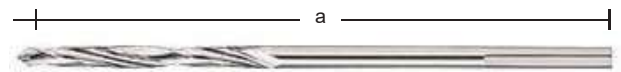

Drills for three-jaw chuck

85 mm	2,0 mm
130 mm	3,2 mm
180 mm	3,2 mm
130 mm	4,5 mm
180 mm	4,5 mm

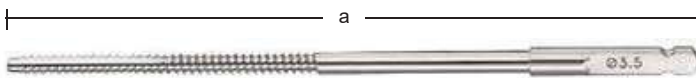

Tap for quick coupling for cortical screws

125 mm 4,5 mm

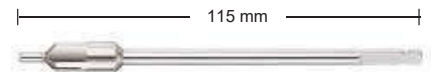

Countersink for quick coupling

for screws Ø 4,5 / 6,5 mm

calibrated



a



Tap for quick coupling for cortical screws

175 mm 4,5 mm

calibrated



200 mm

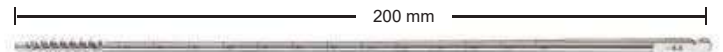

Tap for quick coupling for spongiosa screws

200 mm 6,5 mm

LARGE FRAGMENT INSTRUMENTATION

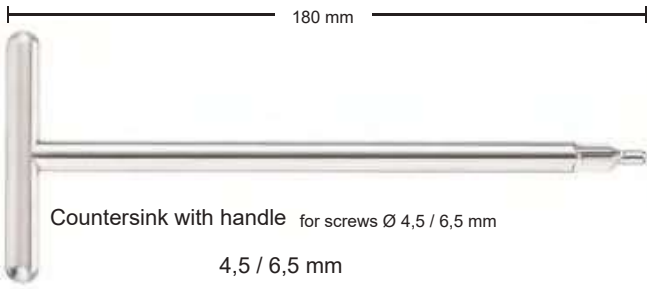

Combination wrench 11 mm

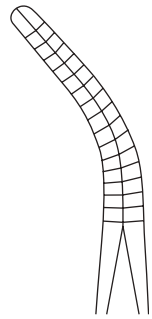

Bone Holding Forceps
20 cm - 83/4"

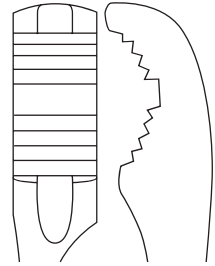

Bone Holding Forceps, Self-Centering

- 24 cm - 9 1/2"
- 26 cm - 10 1/4"
- 28 cm - 11"



PATELLA DOUBLE BONE CLAMP

- 16.5 cm 6 1/2"
- 19.0 cm 7 1/2"
- 21.5 cm - 8 1/2"
- 24.0 cm 9 1/2"
- 26.5 cm - 10 1/2"

LARGE FRAGMENT INSTRUMENTATION



T-Handle, small, with quick coupling



Screwdriver insert hexagonal for quick coupling

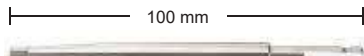

Screwdriver insert hexagonal for quick coupling



Cleaning hook 16 cm - 6 1/4"



Screwdriver Hexagonal 24,5 cm - 9 3/4"



Holding sleeve for screws for screws Ø 4,5 / 6,5 mm



Depth gauge, large for screws Ø 4,5 and 6,5 mm



Bending lever for standard plates

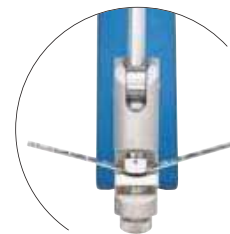

Bending Device for Bone Plates

440 80 mm

With this bending device bone-plates up to a thickness of 6 mm can be bent easily without applying much force. The plates can be bent convex or concave and will not be damaged.

PELVIC INSTRUMENTATION



T-Handle, Small, with Quick Coupling



Screwdriver Hexagonal 30 cm - 113/4"



Screwdriver hexagonal 27 cm - 103/4"



Holding sleeve for screws
for screws Ø



Holding sleeve for screws
for screws Ø4,5 / 6,5mm



Screwdriver insert, hexagonal for quick coupling
16,5 cm - 61/2"



Screwdriver insert, hexagonal for quick coupling
16,5 cm - 61/2"



Depth gauge, large for screws Ø 4,5 / 6,5 mm



Bending lever for reconstruction plates for plates 3,5 / 4,5 mm

PELVIC INSTRUMENTATION



Reposition forceps, large
20 cm - 8"

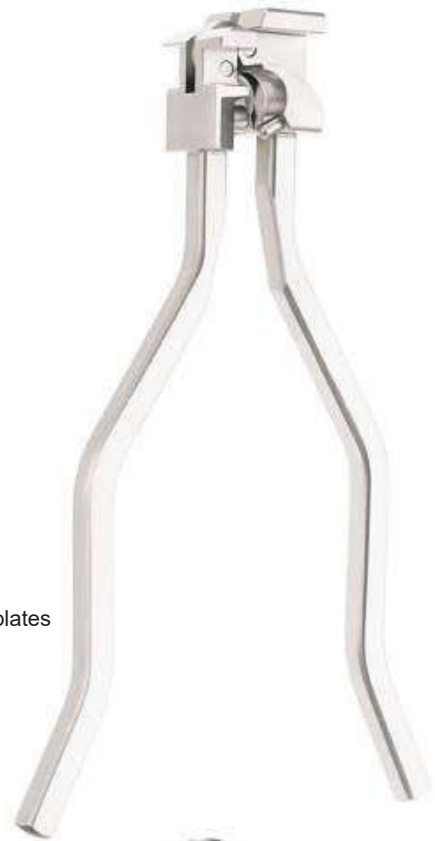

Bending pliers for reconstruction plates
24 cm - 9 1/2"



1338"
Pelvic reposition forceps for screws
34 cm - /



Pelvic reposition forceps angled
19 cm - 7 1/2"

PELVIC INSTRUMENTATION

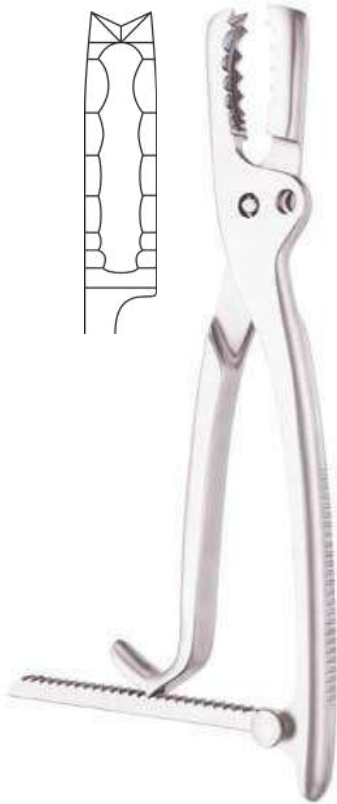

Pelvic reposition forceps

26 cm - 10 1/4"



Pelvic reposition forceps

25 cm - 10"



Pelvic reposition forceps angled
Farabeuf-Lambotte

26 cm - 10 1/4"



Pelvic reposition forceps, large

40 cm

PELVIC INSTRUMENTATION



Pelvic reposition forceps 1 x 2 tips
40 cm - 15 3/4"



Pelvic reposition forceps asymmetric
40 cm - 15 3/4"



Retractor Volkmann
22 cm - 8 3/4"

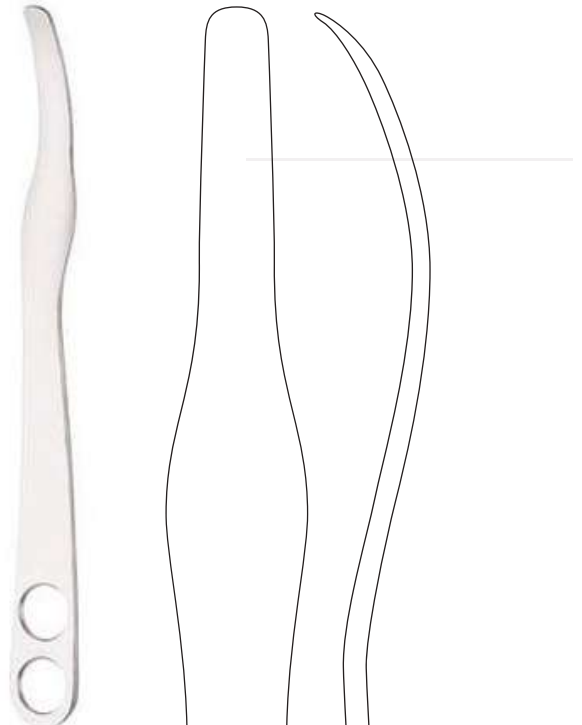

Pelvis lever 27 cm - 10 3/4"

INSTRUMENTATION FOR CANNULATED SCREW

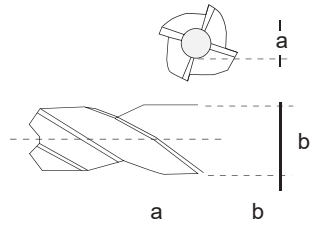
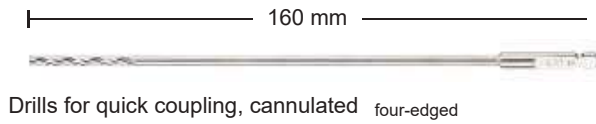

1,35 mm 2,7 mm
1,35 mm 3,5 mm



Countersink for quick coupling, cannulated

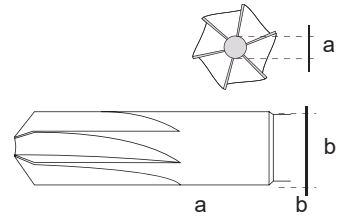

1,35 mm 5,0 mm



with quick coupling Handle **OR-7093010**



Screwdriver Hexagonal Cannulated

OR-7123554



Double drill sleeve



3,5 mm 2,5 mm



Double drill sleeve



2,7 mm 1,25 mm



Holding sleeve for screws
for screws Ø 2.7 mm



Screw holding forceps

INSTRUMENTATION FOR CANNULATED SCREW 4.5mm

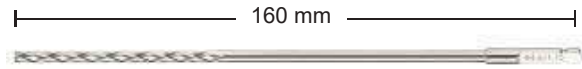

Drills for quick coupling, cannulated four-edged

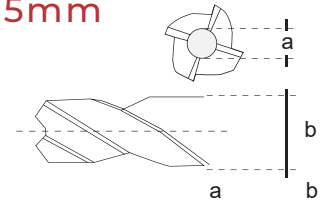

1,75 mm 3,2 mm
1,75 mm 4,5 mm

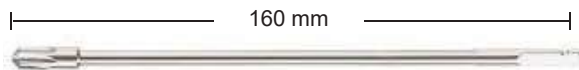

Countersink for quick coupling, cannulated

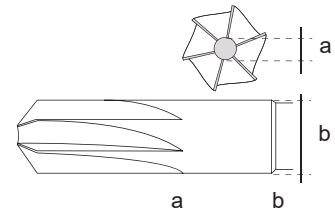

1,8 mm 6,5 mm

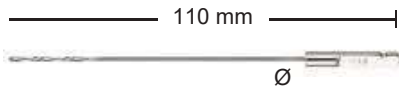

Drill for quick coupling 1,5 mm



T-handle, small, with quick coupling



Double drill sleeve

4,5 mm 3,2 mm



Holding sleeve for screws
for screws Ø 4,5 / 6,5 / 7,0 mm



Screw holding forceps

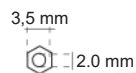

Screwdriver hexagonal
cannulated 2,0 mm

INSTRUMENTATION FOR CANNULATED SCREW 7mm

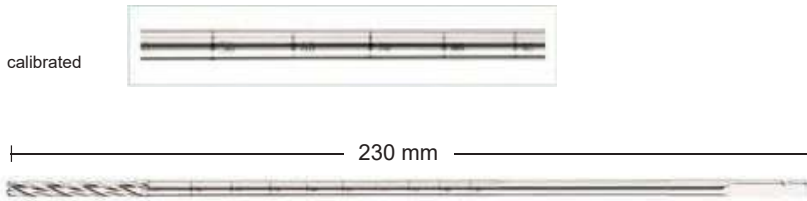

Drill for three-jaw chuck, cannulated four-edged

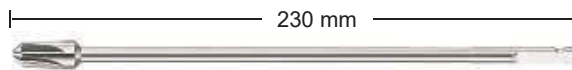
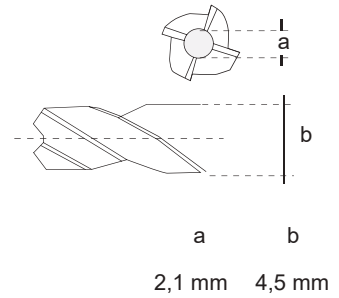

Countersink for quick coupling, cannulated

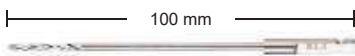
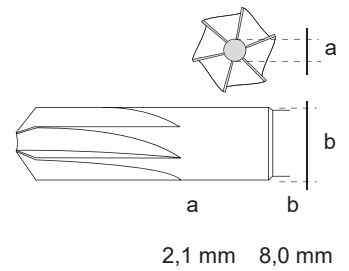

Drill for quick coupling 2,0 mm

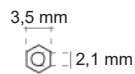

Screwdriver hexagonal
cannulated 2,1 mm



Holding sleeve for screws
for screws

SHOULDER SURGERY INSTRUMENTS

BONE TUNNELLING & SUTURE PASSING

Penetrating Bone Gouge
22cm/83/4" length
3mm wide tip



Percussion Bone Awl
22cm/83/4" length
Curved, with metal handle



Penetrating Bone Awl
18cm/7" length Tufnol
handlee



Crochet Hook Suture Passer
18cm/7" length
Tufnol handle



Suture Passer

18/7" length
Tufnol handle
With hole in tip



SHOULDER SURGERY INSTRUMENTS



Glenoid Perforating Forceps Light Curve
17cm/63/4" length



Glenoid Perforating Forceps Strong Curve
17cm/63/4" length



Kolbel Glenoid Elevator Curved
30cm/12" length, 15mm width, Double prong



Kolbel Glenoid Elevator Curved
30cm/12" length, 20mm width, Double prong



Posterior Glenoid Elevators
Curved tip to sit on posterior rim of Glenoid ,For Posterior Retraction of the ,Humeral Head

Width tip
08mm
12mm
20mm

SHOULDER SURGERY INSTRUMENTS

MURPHY-LANE

30cm/12" length
 Double ended
 20mm and 30mm blade widths



Humerus Head Retractor

18cm/7" length
 Strongly curved
 Double blunt prongs



Bhattman Humerus Head Retractor

25cm/93/4 length
 30mm width
 Double prong



Fukuda Humerus Head Retractor

22.5cm/9" length
 Fenestrated



Width tip
 32mm
 35mm
 37mm

Darrach Acromial Elevators
 , 26cm/101/4" length



SMALL 9mm



MEDIUM 12mm



LARGE 16mm



EXTRA LARGE 25mm

SHOULDER SURGERY INSTRUMENTS

Subacromion Spreader
19cm/7 1/2"
left side ring
right side ring



Subacromion Spreader
25cm/9 3/4" length
Large size
OR-760632 left side ring*
OR-760633 right side ring



Browne Deltoid Retractor
27cm/10 1/2 length
60mm x 65mm blade
Cupped blade

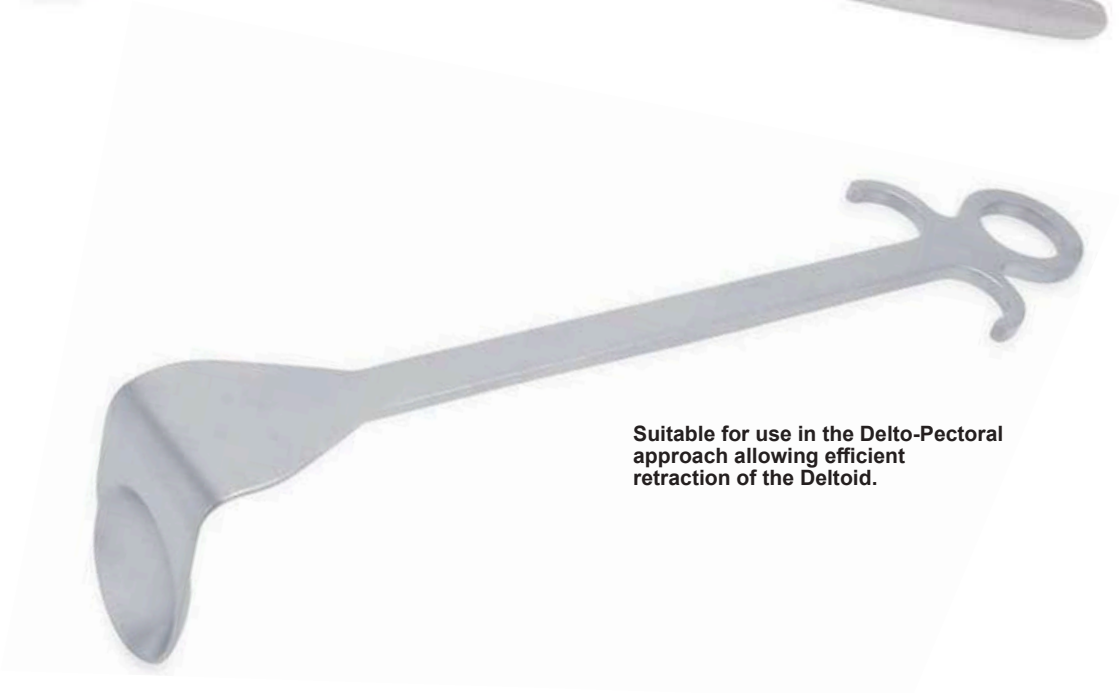

Suitable for use in the Delto-Pectoral approach allowing efficient retraction of the Deltoid.

HIP REVISION INSTRUMENTS

Cup Extraction Chisel

32cm/12½" length
Curved 7mm tip
Metal strike plate
Tufnol handle



Bayonet Gouge

32cm/12½" length
Metal strike plate
Tufnol handle
8mm width



Swan Necked Gouge

28.5cm/11" length
25mm width



Cement Gouge

34.5cm/13½" length
9 mm width-
11mm width-



Cement Chisel Angled

35.5cm/14 length
9mm tip



HIP REVISION INSTRUMENTS

Cement Osteotome

30cm/12" length
Tufnol handle with strike plate

- 4 mm
- 5 mm
- 6 mm
- 8 mm
- 10 mm



Cement Osteotome with guard

30cm/12" length
Tufnol handle with strike plate

- 5 mm
- 10 mm



Straight Cement Gouge

30cm/12" length
Tufnol handle with strike plate

- 5 mm
- 6 mm
- 8 mm
- 10 mm



Bayonet Cement Rasp

52cm/20½" length
Tufnol handle



V-shape



Strong round shape*



Flat round curve

HIP REVISION INSTRUMENTS

Bayonet Cement Osteotome

40cm/15" length
Tufnol handle with strike plate

5 mm
7 mm
10 mm



Bayonet Cement splitting Osteotome with guard

40cm/15" length
Tufnol handle with strike plate

5 mm
7 mm
10 mm



Bayonet Cement Gouge
40cm/15" length
Tufnol handle with strike plate

5 mm
7 mm
10 mm



Bayonet Cement Gouge
40cm/15" length
Tufnol handle

5 mm
7 mm
10 mm



HIP REVISION INSTRUMENTS

Malleable Cement Probe
38cm/15" length
For probing the Femur



Cement Plug Extractor
48cm/19" length
T-handle
For extraction of cement plug



Retrograde Cement Chisel
50cm/19¾" length
Tufnol T-handle
Striking plate



Slotted Mallet



Cement Extraction Hook
34.5cm/14" length, 3mm tip



HIP REVISION INSTRUMENTS



Cement Twist Drill Long
40cm/15³/₄" length

Dia.
6mm
8mm
10mm

Femoral Head Extractor
23cm/9" length
Tufnol handle



Moore Femoral Head
Extractor
20.5cm/8" length
Metal handle



Joint Capsule Clamp
2cm/8" length
25mm jaw length

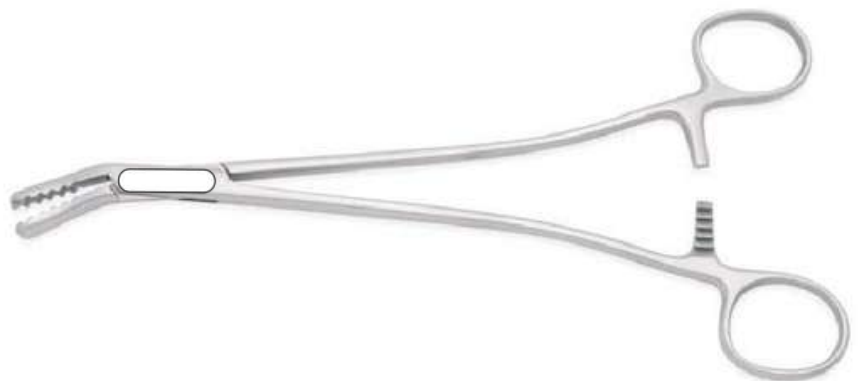

Joint Capsule Scissors
25cm/9³/₄" length
Angled blades



HIP REVISION INSTRUMENTS



MICRO FORCEPS
SERRATED JAW
25cm
35cm

MICRO FORCEPS CUP JAW
STRAIGHT
25cm
35cm

MICRO SCISSORS
STRAIGHT
SIZE 25cm

GRASPING FORCEPS
heavy SIZE 25cm
SIZE 35cm

Femoral Head Impactor
20cm/8" length
Nylon head



OR-760678

McGoey Bone Punch
Double ended

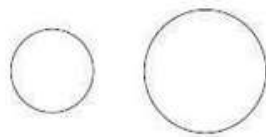

No 1. 13mm x 19mm Ø
Large size



No 2. 6mm x 10mm Ø
*Small size



No 3. 6mm x 13mm Ø
With flats

Hardinge Cement Restrictor
33.5cm/13¼" length
Graduated shaft



BONE FILES

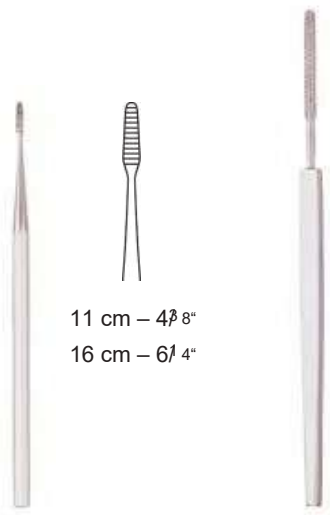

11 cm – 4 3/8"
16 cm – 6 1/4"

Black

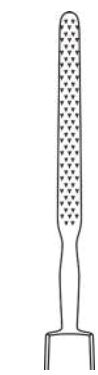

14 cm – 5 1/2"



Joseph



17 cm – 6 3/4"

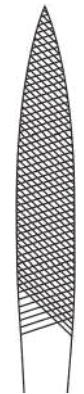

17 cm – 6 3/4"



17 cm – 6 3/4"



Gallaher



19 cm – 7 1/2"

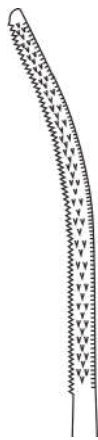

19 cm – 7 1/2"



19 cm – 7 1/2"



27 cm – 10 3/4"

Putti



30 cm – 11 3/4"

Putti



BONE FILES



Miller

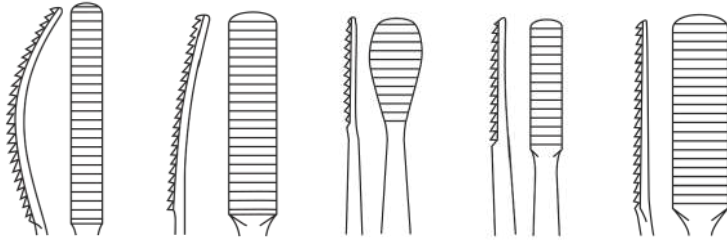

18 cm – 7 1/8" 18 cm – 7 1/8" 18 cm – 7 1/8" 18 cm – 7 1/8" 18 cm – 7 1/8"

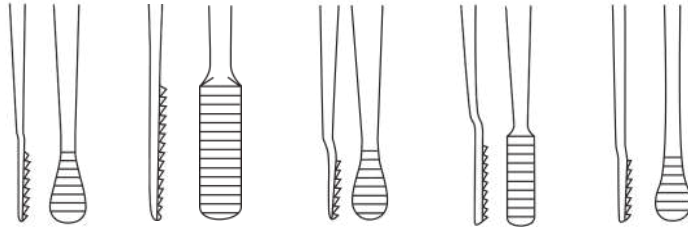

Miller

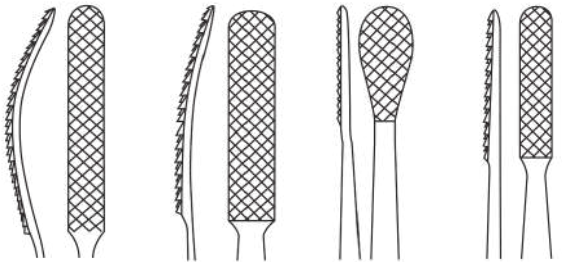

18 cm – 7 1/8" 18 cm – 7 1/8" 18 cm – 7 1/8" 18 cm – 7 1/8"

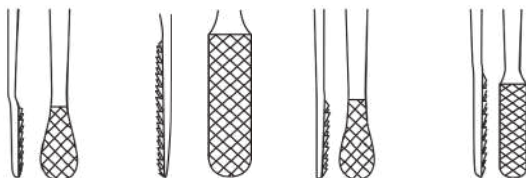

22 cm – 8 3/4"



24 cm – 9 1/2"

ELEVATORS

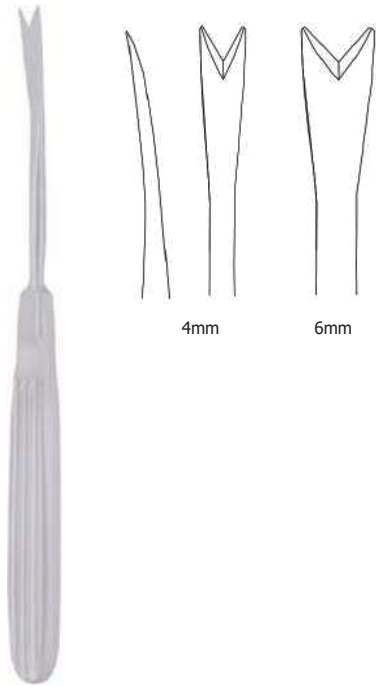

**OBWEGESER (V
SHAPE)
RASPATORIEN**

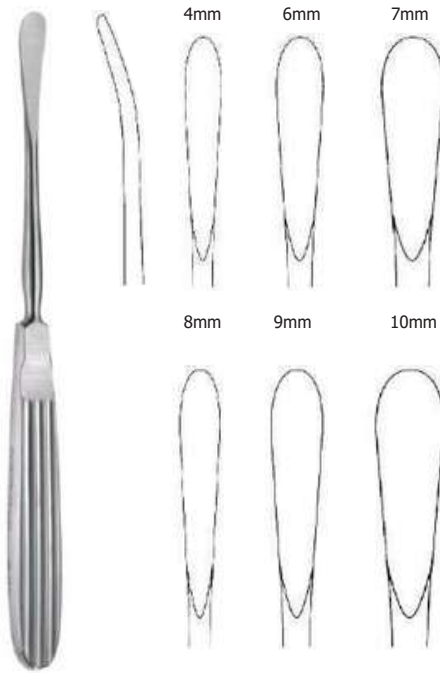

**ADSON PRIOSTEAL
ELEVATOR**



**CUSHING
ELEVATOR SQUARE EDGE
19CM/TIP 16MM**

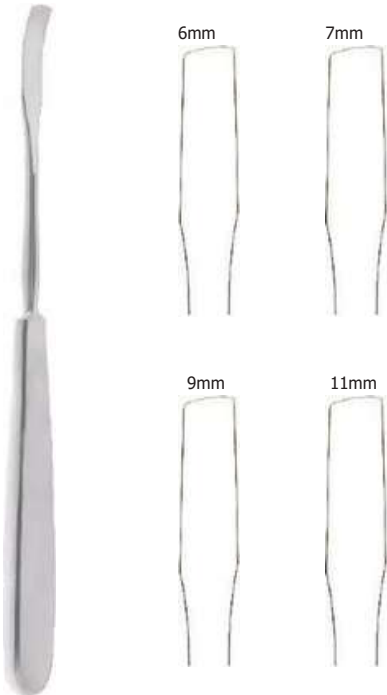

**PERIOSTEM
ELEVATOR 19CM**

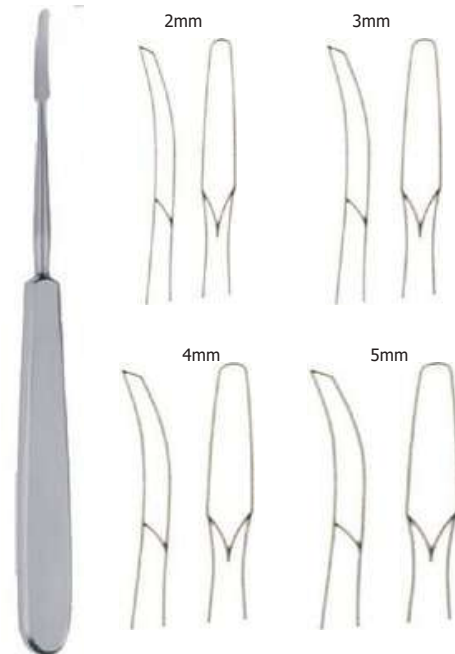

**RASPATORIEN
(SAHRAP)**



**CUSHING
ELEVATOR ROUND EDGE
19CM/TIP 16MM**

ELEVATORS



FREER, 19CM
ELEVATOR BROAD



FREER, 19CM
ELEVATOR FINE



FREER, 19CM
ELEVATOR



MASING, 19CM
ELEVATOR GRADUATED



HOWARTH, 19CM
ELEVATOR



DISSECTOR, 20CM
WITH SUCCER



COHEN, 19CM
ELEVATOR



WOODSON DURAL, 19CM
SEPARATOR & PACKER,



WATSON CHEYENE 19CM
DOUBLE ENDED
PROBE DISSECTOR



DAVIS DISSECTOR
24CM

RASPATORIES

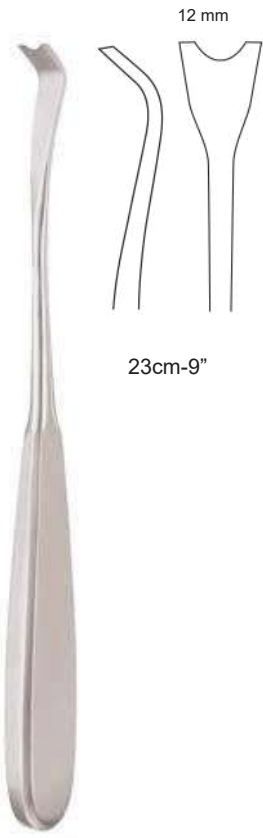

Semb



Semb

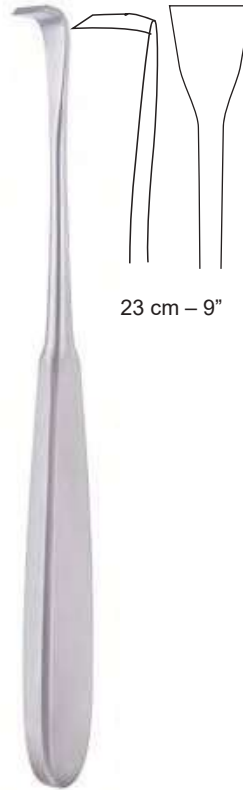

Semb

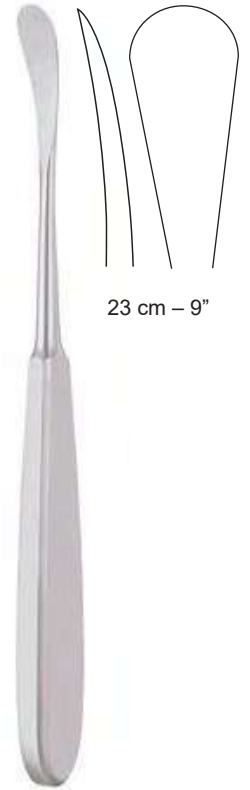

Semb

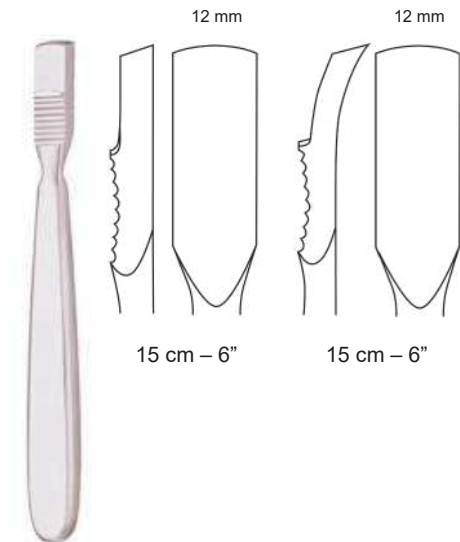

Farabeuf

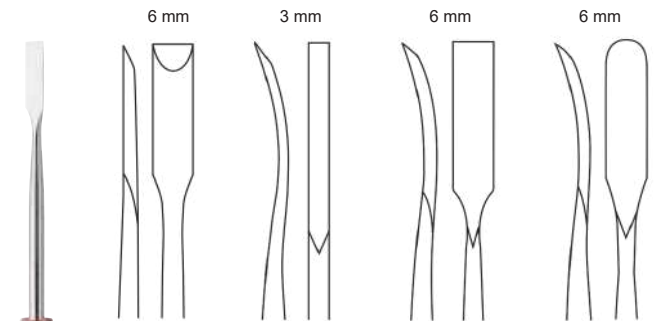

18,5 cm - 7 1/4" 18,5 cm - 7 1/4" 18,5 cm - 7 1/4" 18,5 cm - 7 1/4"



Cushing

RASPATORIES

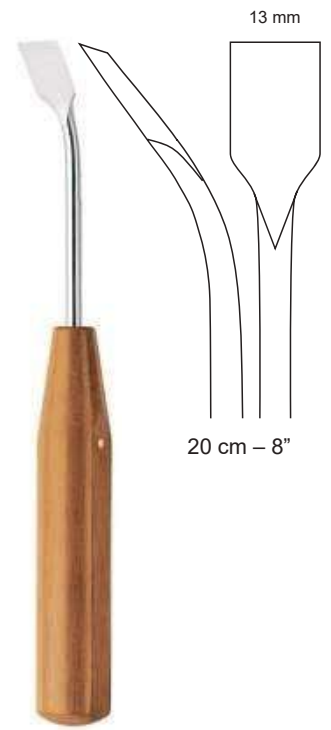
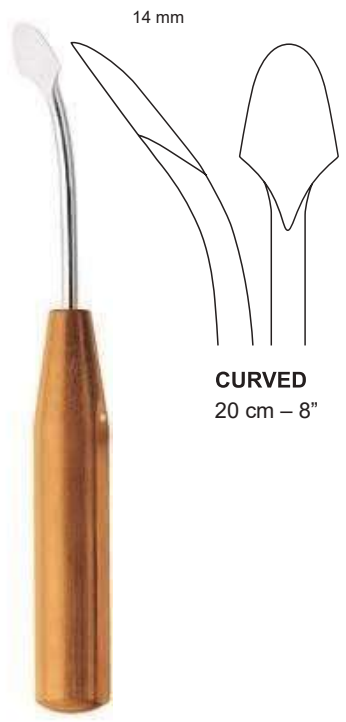

COBSPINAL ELEVATOR

31cm 12¼" OVERALL LENGTH 18cm HANDLE

SIZE

- 10mm
- 13mm
- 19mm
- 16mm
- 22mm
- 25mm

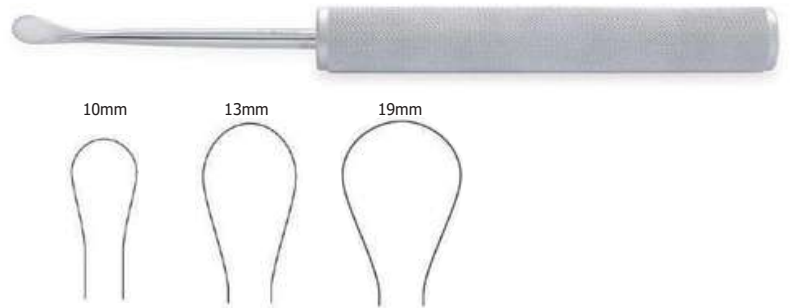

COB SPINAL ELEVATOR

EXTRA LONG HANDLE, 34cm 13½" OVERALL LENGTH 22cm 8¾" HANDLE LENGTH

SIZE

- A
- 10mm
 - 15mm
 - 20mm
 - 25mm
 - 30mm



ZIELKE S-SHAPED GOUGE

23cm/9" LENGTH ILLUSTRATED

SIZE

- 6mm
- 9mm
- 6mm
- 9mm



COB SPINAL GOUGE

23cm/9" LENGTH ILLUSTRATED

SIZE

- 6mm
- 6mm



CAPENER LAMINA GOUGE

23cm/9" LENGTH CRANKED SHAFT

SIZE

- 6mm
- 8mm
- 11mm
- 16mm



RASPATORIES

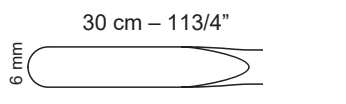
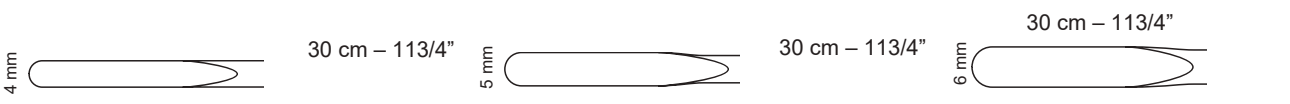
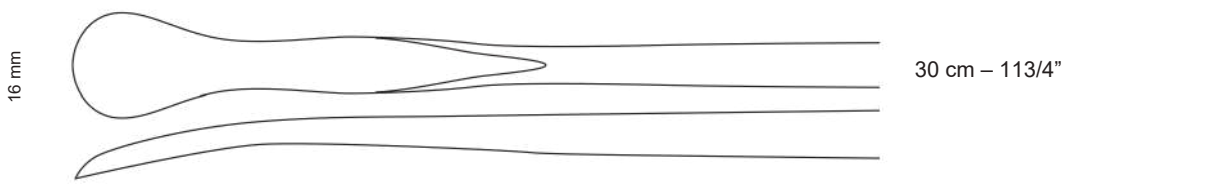
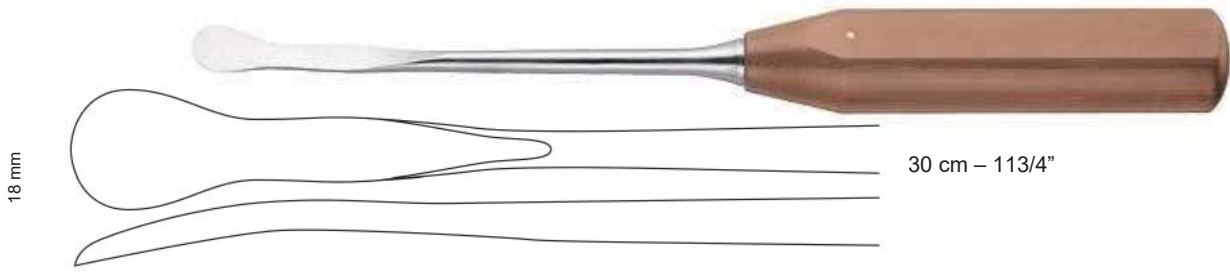
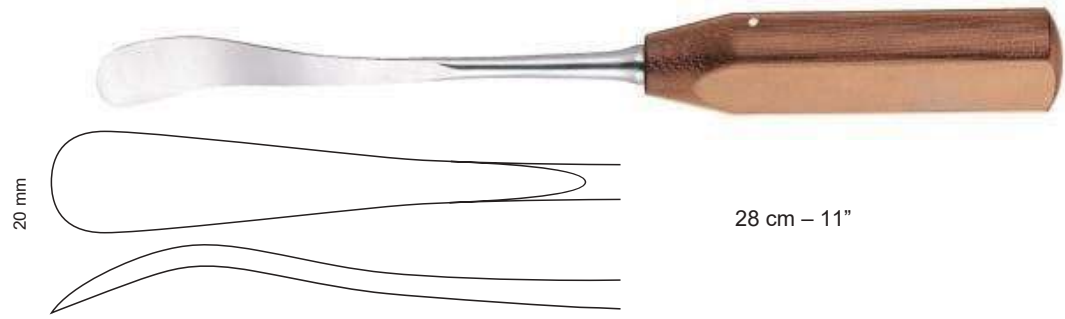
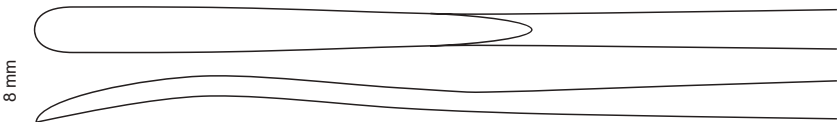
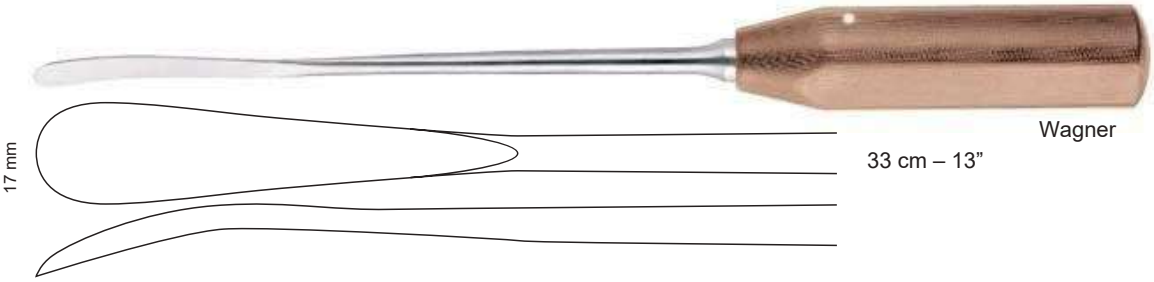

CHISELS & GOUGES



Spare screw

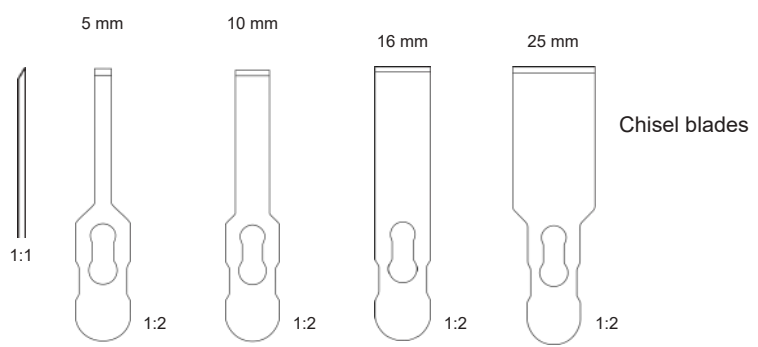

8,5 cm – 3 1/4" 8,5 cm – 3 1/4" 8,5 cm – 3 1/4" 8,5 cm – 3 1/4"

18,5 cm – 7 1/4"



9 cm – 3 1/2"

Wrench

r = 50 mm

r = 60 mm

r = 70 mm

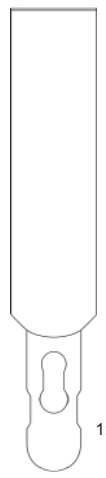

13,5 cm – 5 3/8"

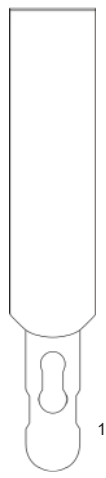

13,5 cm – 5 3/8"

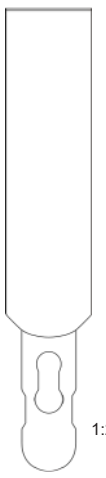

13,5 cm – 5 3/8"

Gouge blades

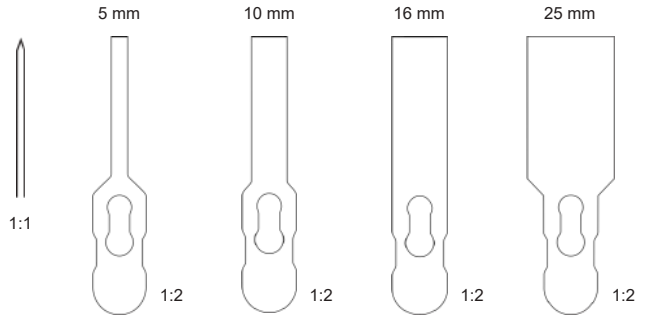

8,5 cm – 3 1/4" 8,5 cm – 3 1/4" 8,5 cm – 3 1/4" 8,5 cm – 3 1/4"

Osteotome blades

OSTEOTOME, FIBER HANDLE

LENGTH TUFNOL HANDLE 25cm 9 3/4"

- SIZE**
- 5 mm
 - 8 mm
 - 10mm
 - 12mm
 - 14mm
 - 16mm
 - 18mm
 - 20mm
 - 25mm
 - 30mm



CHISELS, FIBER HANDLE

LENGTH TUFNOL HANDLE 25cm 9 3/4"

- SIZE**
- 5 mm
 - 8 mm
 - 10 mm
 - 14 mm
 - 15 mm
 - 18 mm
 - 20mm
 - 22mm
 - 25mm
 - 30mm



GOUGE, FIBER HANDLE

LENGTH TUFNOL HANDLE 25cm 9 3/4"

- SIZE**
- 5 mm
 - 8 mm
 - 10 mm
 - 12 mm
 - 14 mm
 - 15 mm
 - 16 mm
 - 18 mm
 - 20 mm
 - 25 mm
 - 30mm



SCAGLIETTI OSTEOTOME

26cm 10 1/4" LENGTH

- SIZE**
- 6mm
 - 9mm
 - 12mm
 - 16mm
 - 19mm



CHISELS & GOUGES

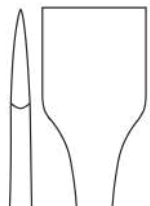

18 cm – 7 1/8"

- 2 mm
- 4 mm
- 6 mm
- 8 mm
- 10 mm
- 12 mm
- 15 mm
- 20 mm

Mini-Lexer **CHISEL**
18 cm – 7 1/8"

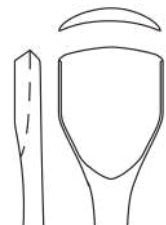

18 cm – 7 1/8"

- 2 mm
- 4 mm
- 6 mm
- 8 mm
- 10 mm
- 12 mm
- 15 mm
- 20 mm

Mini-Lexer **GOUGE**
18 cm – 7 1/8"

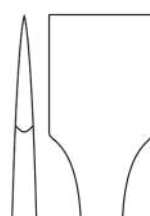

22 cm – 8 3/4"

- 7 mm
- 10 mm
- 15 mm
- 20 mm
- 25 mm
- 30 mm

Mini-Lexer **CHISEL**
22 cm – 8 3/4"

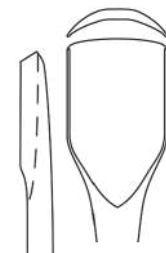

22 cm – 8 3/4"

- 7 mm
- 10 mm
- 12 mm
- 15 mm
- 20 mm
- 25 mm
- 30 mm

Mini-Lexer **GOUGE**
22 cm – 8 3/4"

CHISELS & GOUGES



Dahmen **CHISEL**

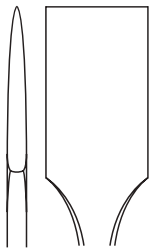

30 cm – 113/4"

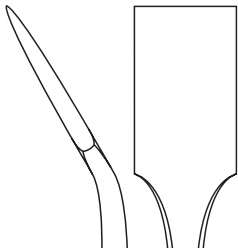

30 cm – 113/4"

- 4 mm
- 5 mm
- 6 mm
- 8 mm
- 10 mm
- 12 mm
- 15 mm
- 20 mm
- 22 mm
- 25 mm

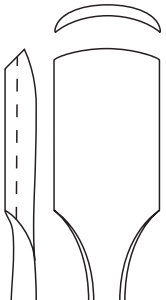

STRAIGHT

30 cm – 113/4"

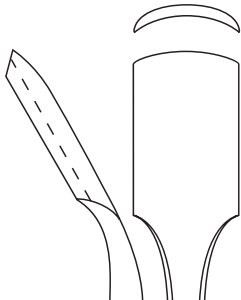

LEFT

30 cm – 113/4"

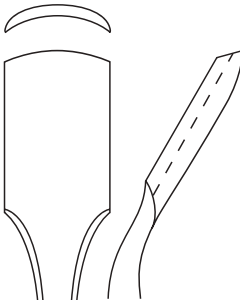

RIGHT

30 cm – 113/4"

- 4 mm
- 5 mm
- 6 mm
- 8 mm
- 10 mm
- 12 mm
- 15 mm
- 20 mm
- 22 mm
- 25 mm



Dahmen **GOUGE**

MINISTILLE OSTEOTOME

STRAIGHT 16cm 6 1/4"



STILLEOSTEOTOME



MEINAIS USTRILNLGE COHSITLEEOTOME



STILLE CHISEL



LAMBOTTE OSTEOTOME



SMITH PETERSON

GOUGE
25cm 9¾" LENGTH

- SIZE**
6mm
9mm
13mm
16mm
19mm
25mm
32mm



SMITH PETERSON

OSTEOTOME
20cm 8" LENGTH

- SIZE**
B 10 m m
B 15 m m
B 20 m m
B 25 m m
B 30 m m



KILLIAN GOUGE

S,1T6RcAmI GLHENT G1T6Hcm6¼"

- SIZE**
4mm
5mm



TILLEY SEPTUM GOUGE

- SIZE**
4mm
5mm



SILVER CHISEL

S1T6RcAmI G6H¼T"16cm6¼"

- SHAPE**
STRAIGHT
RIGHT
LEFT

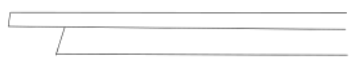

MALLETS

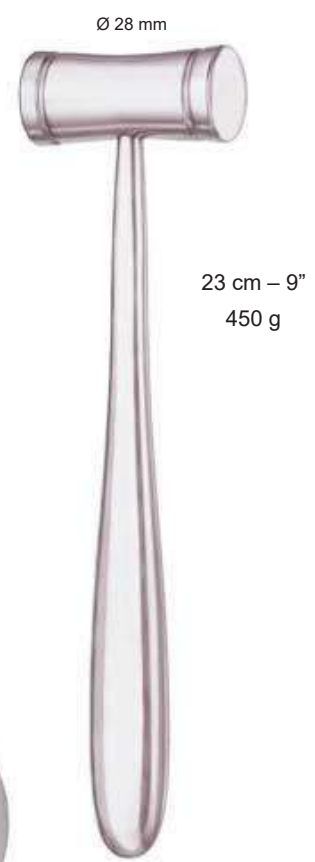

MALLETS

Ø 40 mm



24 cm – 9 1/2"

550g

Ombredanne

Ø 42/30 mm



24 cm – 9 1/2"

530 g

Ø 25 mm



23 cm – 9"

335 g

Ø 19 mm



19 cm – 7 1/2"

230 g

40 mm



19,5 cm – 7 3/4"

700 g

Kirk

CURETTES



Volkmann

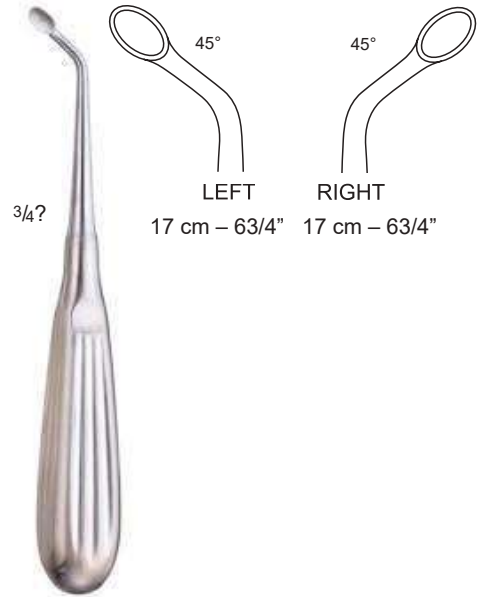
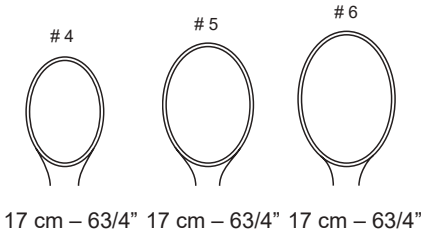
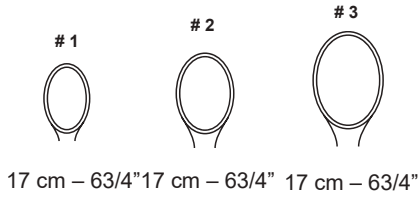
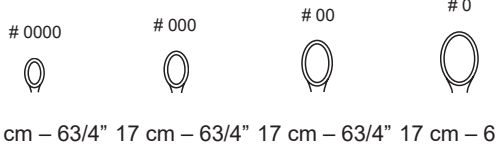

Uffenorde

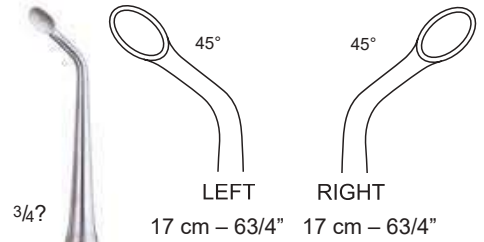

Bruns

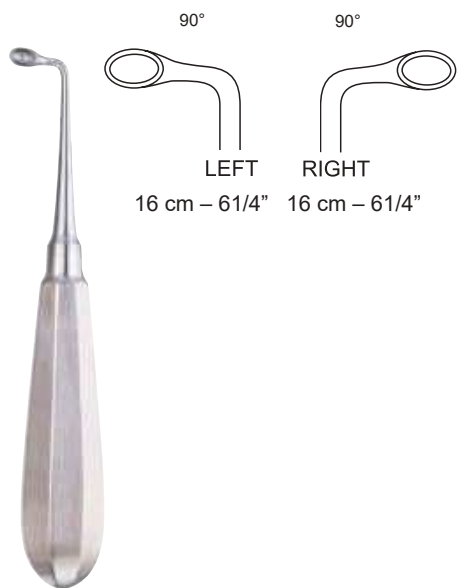
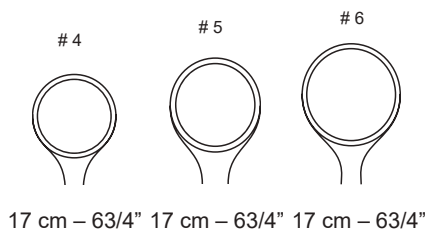
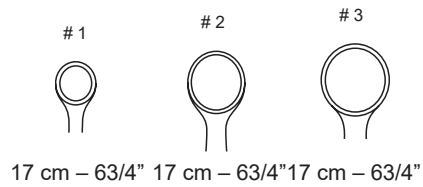

Siebenmann

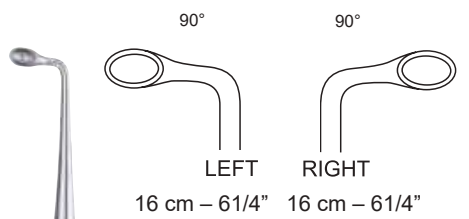

CURETTES



LAMPERTCURETTE
STRAIGHT/ANGLED 21cm/8¼"



STRAIGHT

- SIZE**
1.0mm
1.5mm
2.0mm
2.5mm
3.0mm
3.5mm
4.0mm
4.5mm
5.0mm



ANGLED

- SIZE**
1.0mm
1.5mm
2.0mm
2.5mm
3.0mm
3.5mm
4.0mm
4.5mm
5.0mm



BRUNSCURETTE
STRAIGHT/ANGLED 10"



STRAIGHT

- SIZE**
2.5MM
3.0MM
3.5MM
4.0MM
4.5MM
5.0MM



ANGLED

- SIZE**
2.5MM
3.0MM
3.5MM
4.0MM
4.5MM
5.0MM



DOWN

- SIZE**
1.5MM
2.0MM
2.5MM
3.0MM
3.5MM
4.0MM
4.5MM
5.0MM



LONG SPINAL
MICRO CURETTE 25CM/10"



STRAIGHT

- SIZE**
3MM
4MM
5MM



ANGLED

- SIZE**
3MM
4MM
5MM



CLONBGB SAPNITNEARLI OR
CURETTE 3289cm/151"1/2"
OVERALL LENGTH



STRAIGHT

- SIZE**
3mm
4mm
5mm
6mm
7mm
8mm



ANGLED

- SIZE**
3mm
4mm
5mm
6mm
7mm
8mm

CURETTES

VOLKMANNDOUBLE ENDED CURETTE 22CM

SIZE
3MM/5MM
4MM/6MM
5MM/7MM



CLOWARDRINGCURETTE 23 cm / 9"

SIZE
3mm
6mm
8mm
3mm
6mm
8mm



CERVICAL BONE GRAFT IMPACTOR 90° AND 30° OFFSET

TIP DIA
6mmx12mm TIP 90°
3.5mmx6mm TIP 90°



CASPER BONE IMPACTOR 8"/20CM

TIP DIA
3mm
5mm
8mm



CLOWARD TYPE BONE GRAFTI IMPACTOR, DOUBLE ENDED 11/14MM



CLOWARD DEPTH GAUGE



BONE NIBBLERS

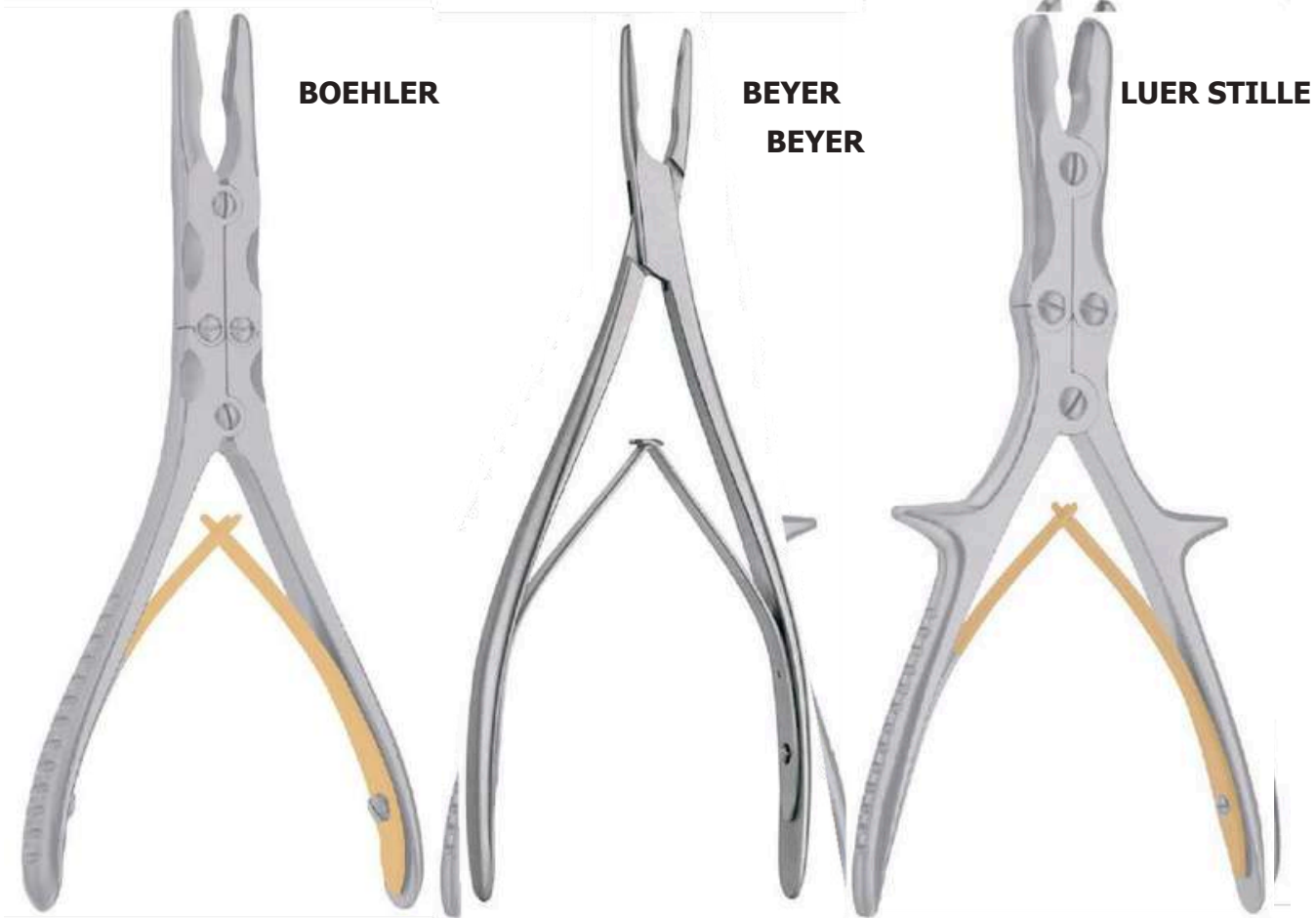

BONE BITING RONGEURS

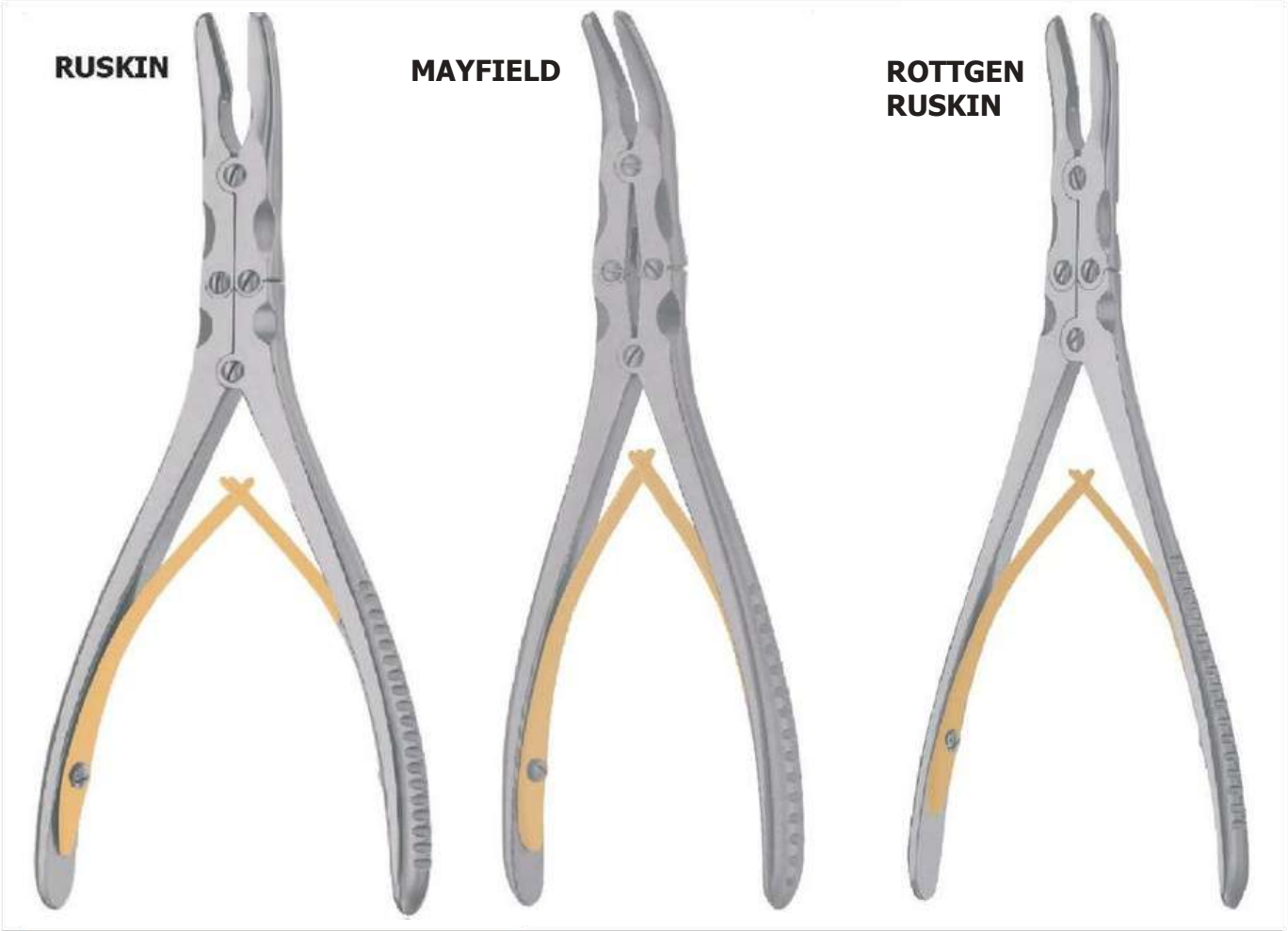

RUSKIN

MAYFIELD

**ROTTGEN
RUSKIN**

BONE BITING RONGEURS

BONE NIBBLERS

STILLE-RUSKIN



SMITH-PETERSON



LEKSELL



BONE BITING RONGEURS

CUTTERS



Liston



14 cm – 5 1/2"



17 cm – 6 3/4"



20 cm – 8"



22 cm – 8 3/4"



15 cm – 6"



14 cm – 5 1/2"



17 cm – 6 3/4"



20 cm – 8"



22 cm – 8 3/4"



Liston-mini



15 cm – 6"

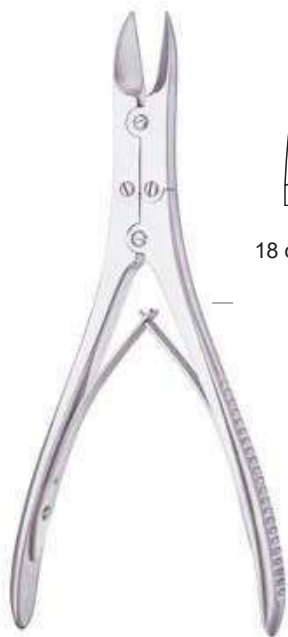

Ruskin-Rowland



18 cm – 7 1/8"



18 cm – 7 1/8"



McIndoe



18 cm – 7 1/8"



18 cm – 7 1/8"

CUTTERS



27 cm - 10 1/2"

T.C

TOP CUTTER



23 cm - 9"

T.C

TC WIRE CUTTER



19 cm - 7 1/2"

23 cm - 9"

T.C

WIRE CUTTER



DE VIBISS SKULL PUNCH



RIB SHEARS



WIRE CUTTING PLIER



17.5 cm - 7"

CUTTERS

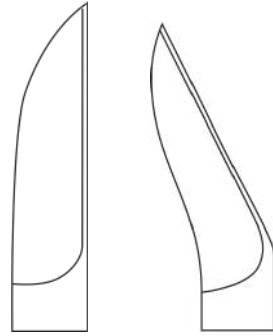

24cm – 9 1/2"
28 cm – 11"

24cm – 9 1/2"
28 cm – 11"

Liston-Stille

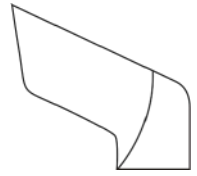

26 cm – 10 1/4"

Liston-Key

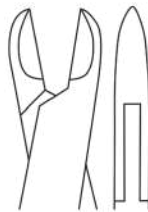
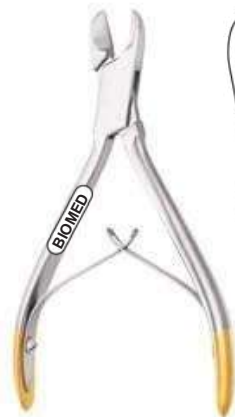

12 cm – 4 3/4"

T.C

Wire Cutter

BONE HOLDING FORCEPS



18 cm – 7 1/8"

Lewin



Sequestrum forceps

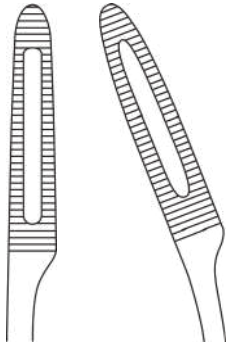

20 cm – 8"

20 cm – 8"



Van Buren



23 cm – 9"

max. 25 mm



Kistler-Manus
15,5 cm – 6 1/8"



13,5 cm – 5 3/8"



13,5 cm – 5 3/8"



18 cm – 7"

20 cm – 8"

23 cm – 9"

26 cm – 10"

BONE HOLDING FORCEPS



14 cm – 5 1/2"

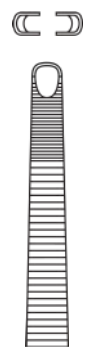

19 cm – 7 1/2"

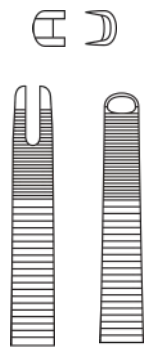

19 cm – 7 1/2"



16 cm – 6 1/4"

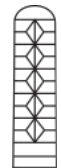

19 cm – 7 1/2"

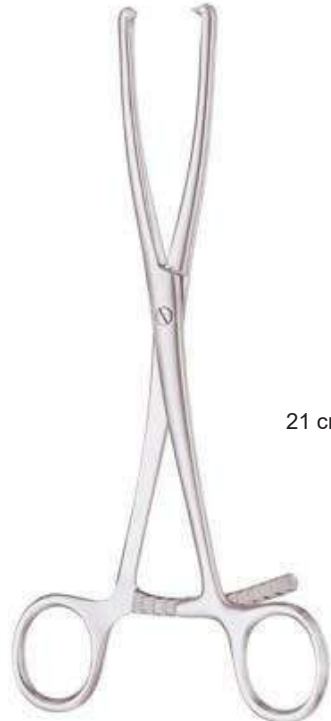

21 cm – 8 1/4"

Martin
Cartilage and meniscus forceps

Martin
Cartilage and meniscus forceps

BONE HOLDING FORCEPS



20 cm – 8"

Bircher
Cartilage and meniscus forceps



21 cm – 8 1/4"

Cartilage and meniscus forceps



20 cm – 8"



20 cm – 8"

Bircher-Ganske
Cartilage and meniscus forceps

BONE HOLDING FORCEPS



20 cm – 8"

Semb



20 cm – 8"

Semb
with Ratchet



Kern

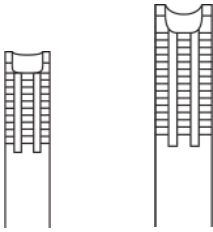

14 cm – 5 1/2" 23 cm – 9"



Kern

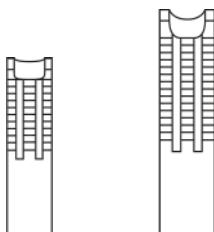

14 cm – 5 1/2" 23 cm – 9"



Langenbeck



20 cm – 8"

BONE HOLDING FORCEPS



Ulrich

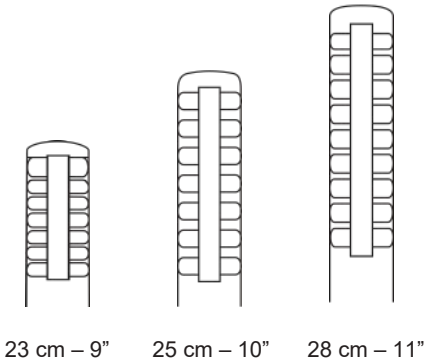

Ulrich

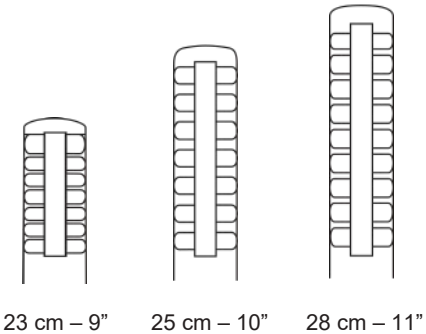

Lane

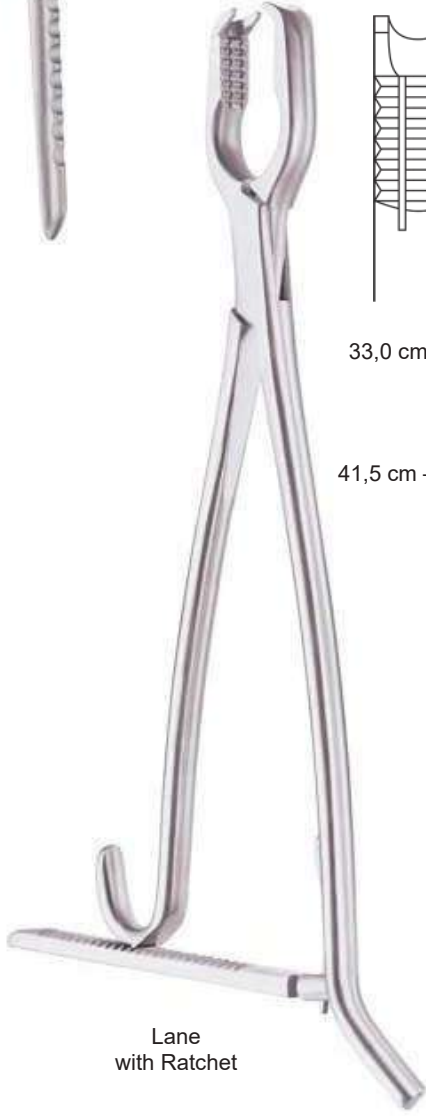
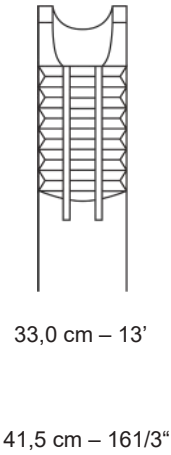

Lane
with Ratchet

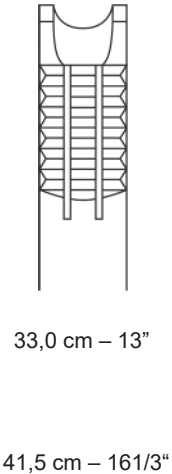

BONE HOLDING FORCEPS

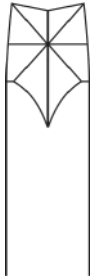

21 cm – 8 1/4"

Fergusson

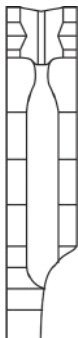

23 cm – 9"

25 cm – 10"

Farabeuf

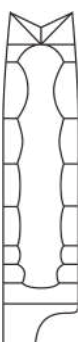

26 cm – 10 1/4"

Farabeuf-Lambotte



17,5 cm – 7"

Verbrugge



18 cm – 7 1/8"

20 cm – 8"

22 cm – 8 3/4"

Bone Holding Clamps

Lowman

BONE HOLDING FORCEPS



26 cm – 10 1/4"

Verbrugge



Self-centering

15 cm – 6"

19 cm – 7 1/2"

24 cm – 9 1/2"

26 cm – 10 1/4"

Verbrugge

28 cm – 11"

REAMERS



17 cm – 63/4"
Bone drill

Championniere



15 cm – 6"



16 cm – 63/4"



21 cm – 81/4"

Perthes



22 cm – 83/4"

Perthes

BONE LEVERS

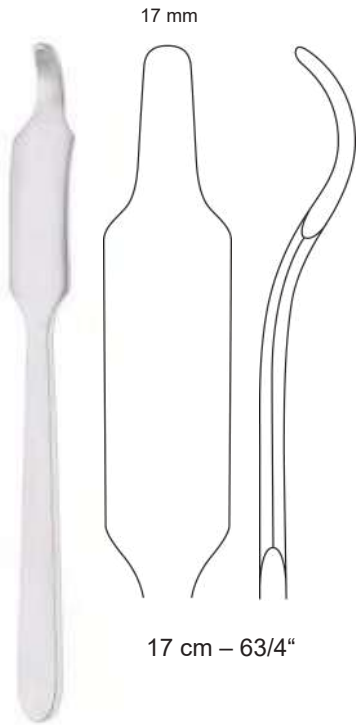

Lange-Baby

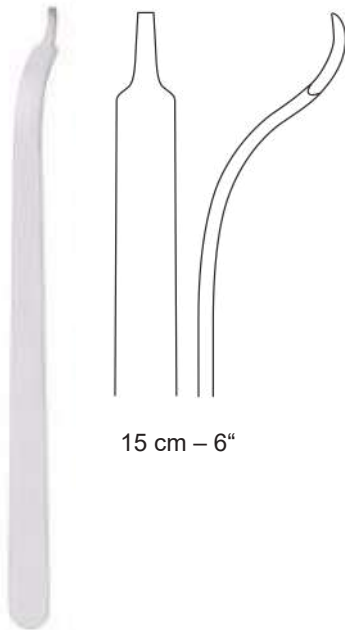
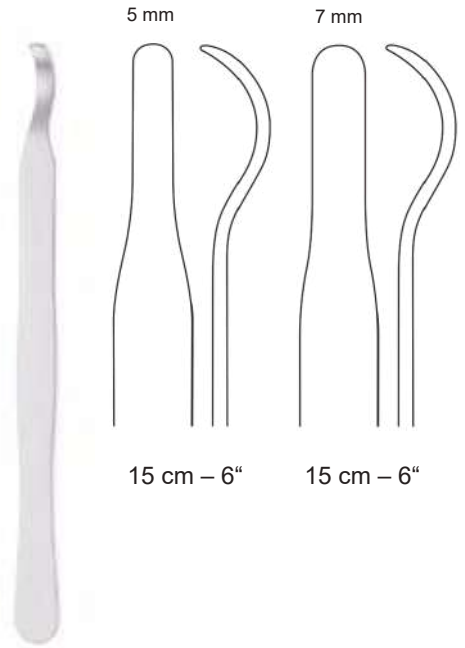
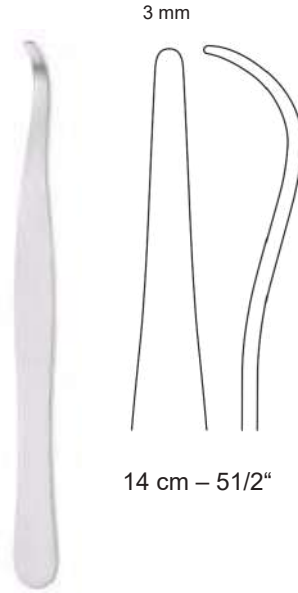

Buck-Gramcko

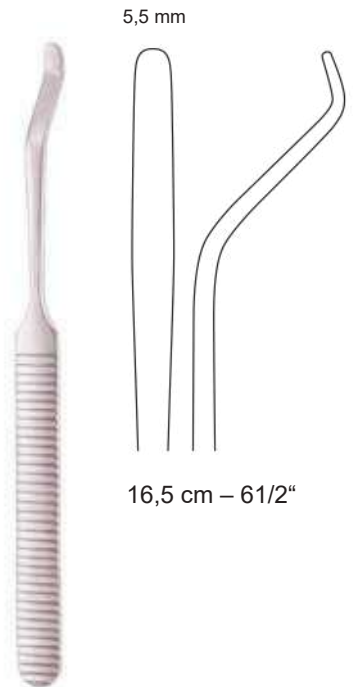
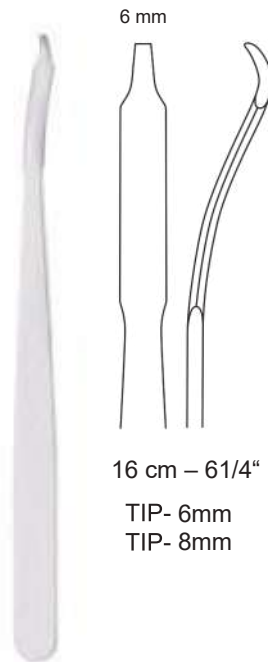

BONE LEVERS



21 cm – 8 1/4"

Lane



Dingman

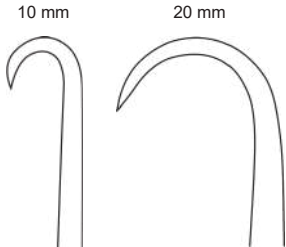

18 cm – 7 1/8" 17 cm – 6 3/4"



27 cm – 10 3/4"



Wroblenski Dislocating Hook
25cm/10" length hooking around the neck of the Femur



McMinn Dislocating Hook
25cm/10" length
Blunt hook with Tufnol handle



Lambotte

BONE LEVERS

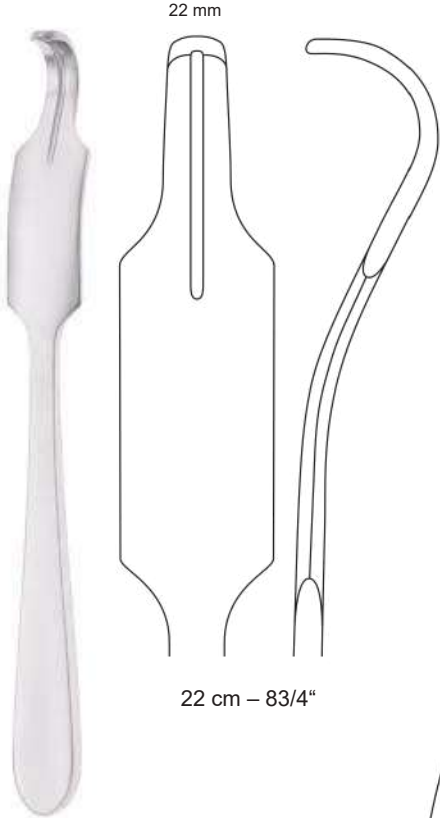

Lange

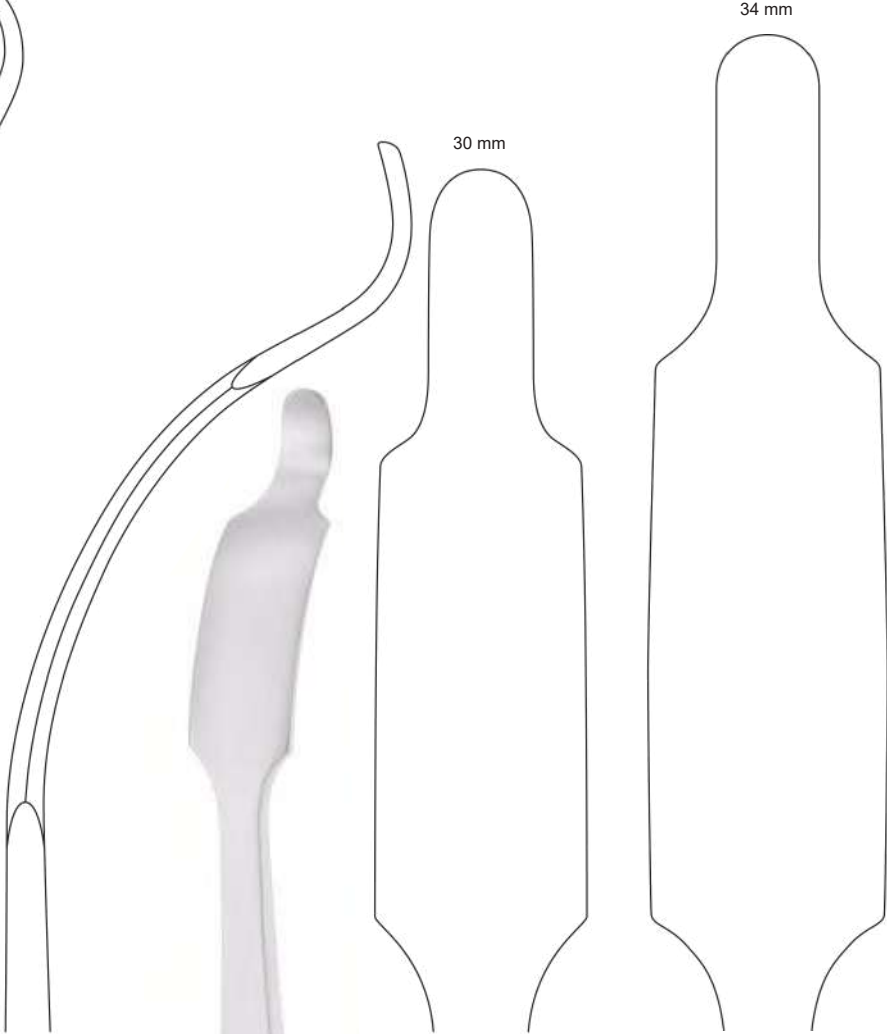

Lange-Hohmann

BONE LEVERS



Lange-Hohmann modif.

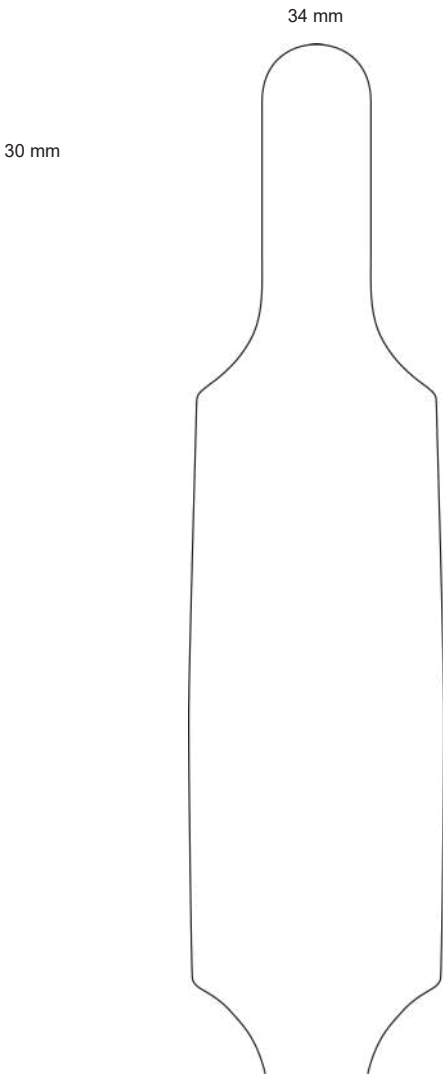

27 cm – 10 3/4"

29 cm – 11 3/8"



Lange-Hohmann

25 mm

27 cm – 10 3/4"

BONE LEVERS

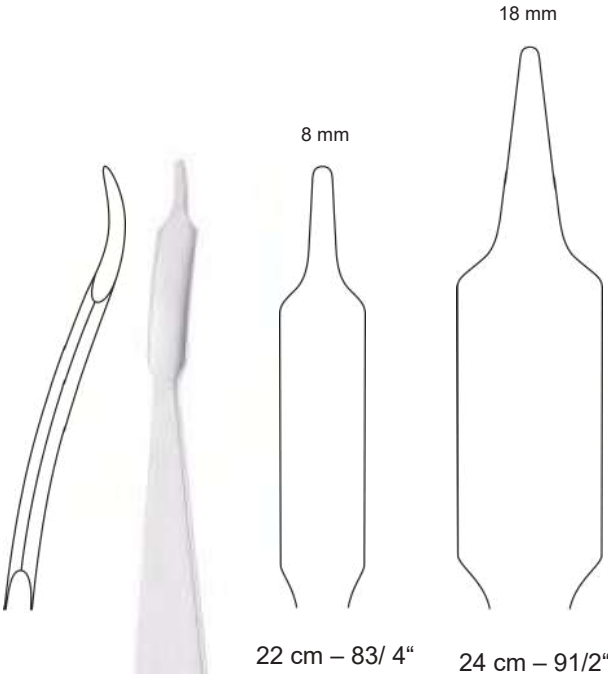

Hohmann

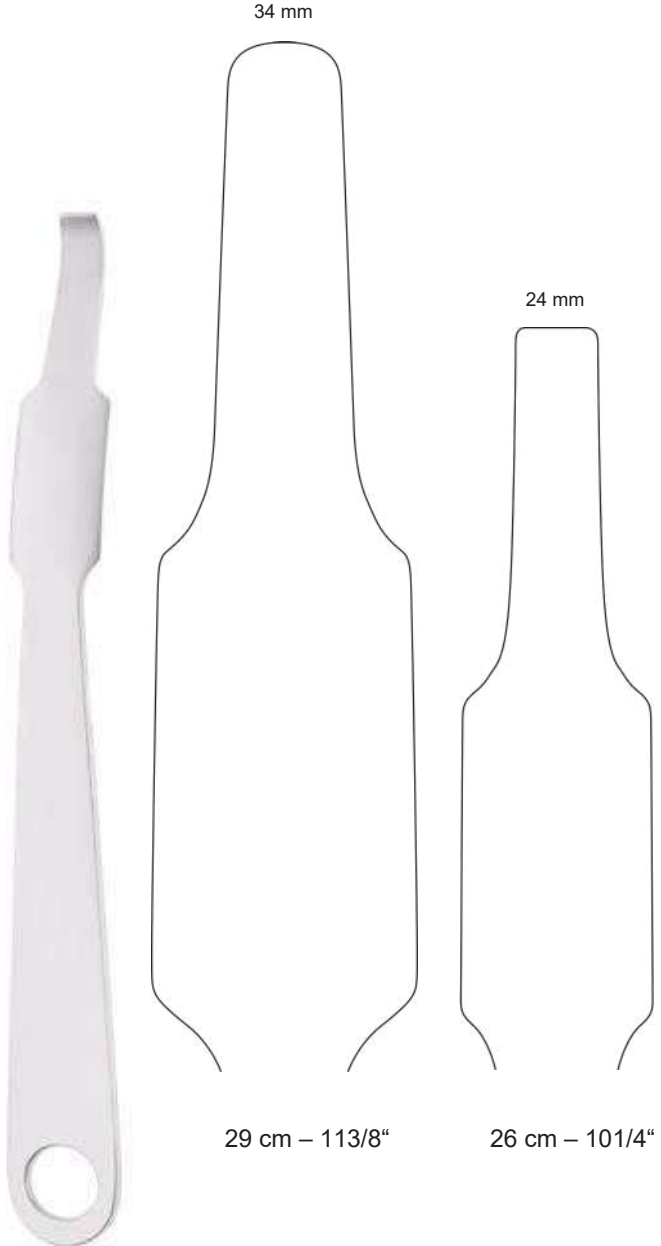
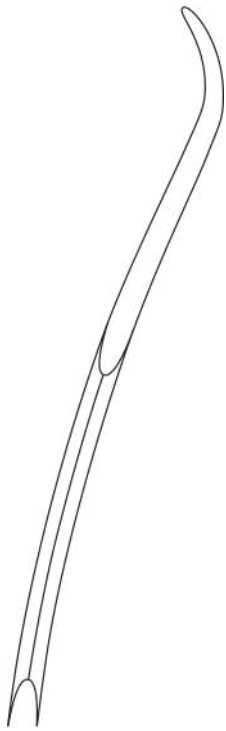

Hohmann

BONE LEVERS

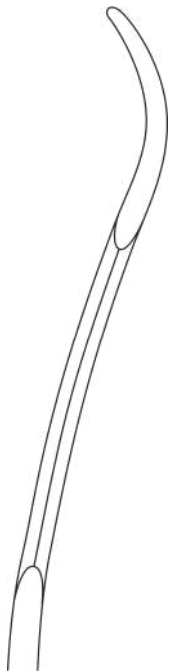

Verbrugge-Hohmann

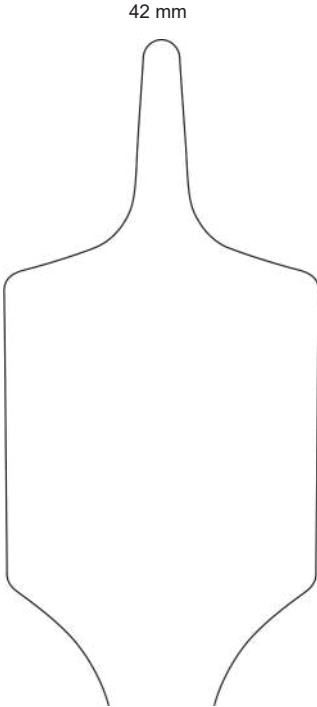

24 cm – 9 1/2"

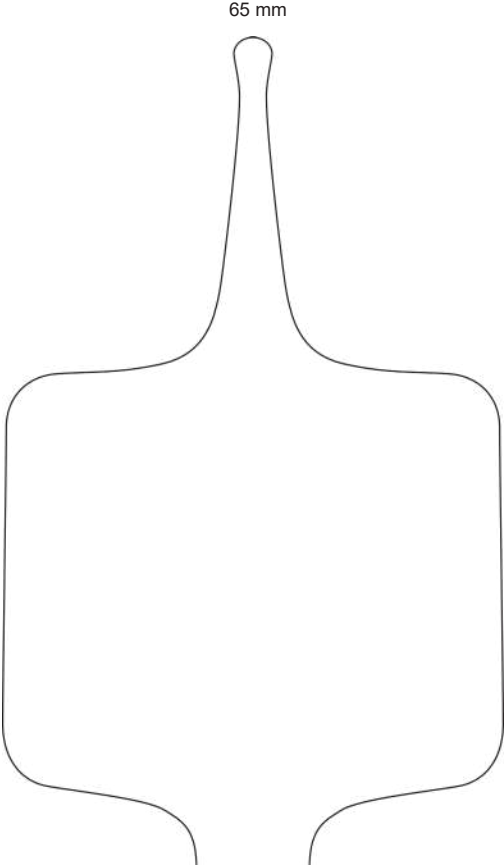

25 cm – 10"

BONE LEVERS

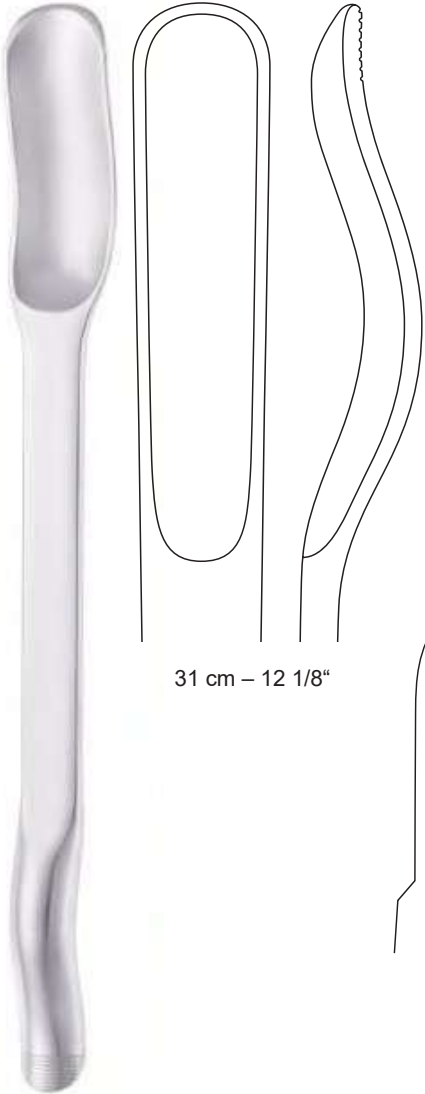

31 cm – 12 1/8"

Murphy-Lane



65 mm

45 mm

24 cm – 9 1/2"

24 cm – 9 1/2"

Bennett

BONE LEVERS

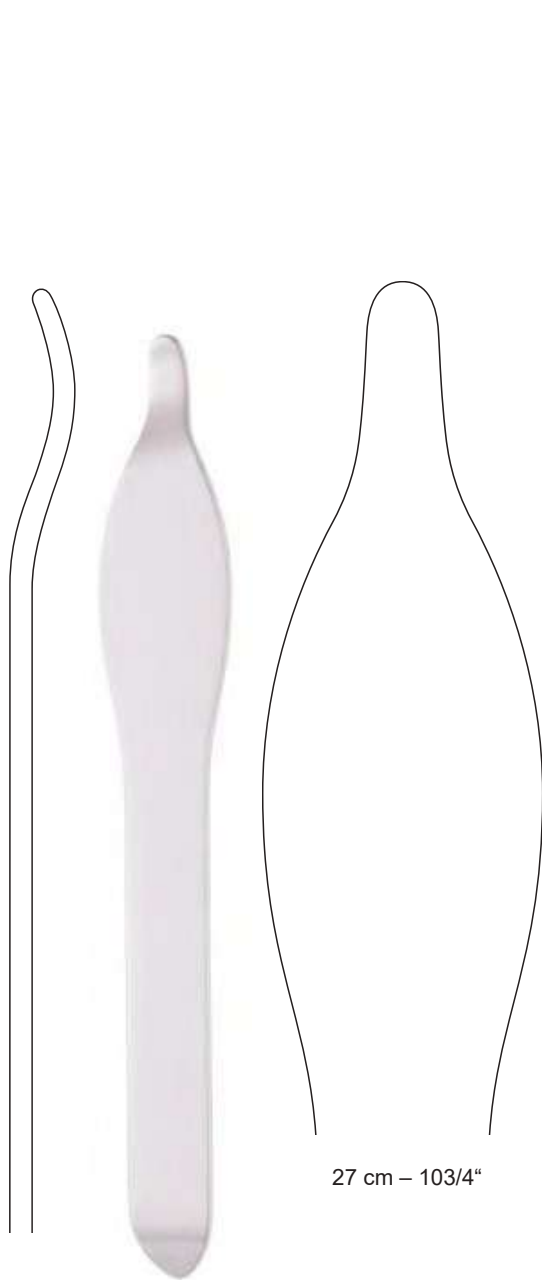

BONE LEVERS



Long Curved Hohmann Inferior Hip Elevator
40cm/16" length ,22mm width



Modified Hohmann Elevator
10mm
18mm
25mm
43mm
70mm



Modified Cobra Aufrang Elevator
33cm/13" long blade ,30mm x 100mm



Shallow Bone Elevator
25cm/9¾" length



Concave Moor Elevator
33cm/13" long blade

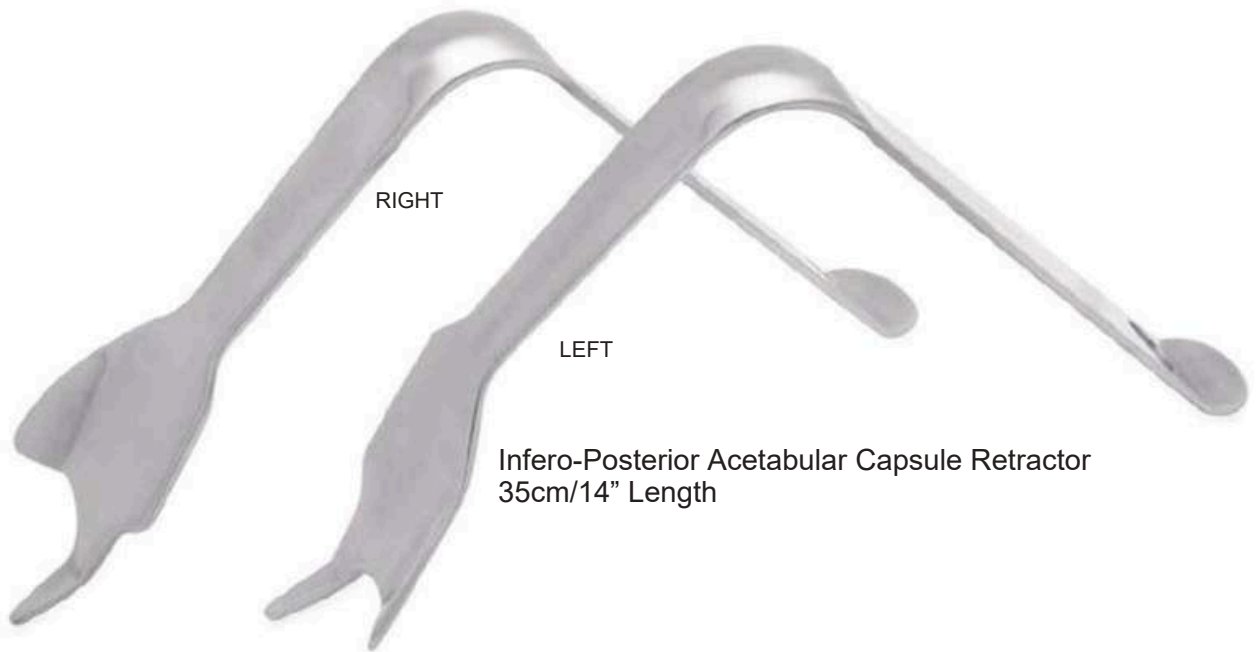

RIGHT

LEFT

Infero-Posterior Acetabular Capsule Retractor
35cm/14" Length



















PCL Retractor
25cm/10" Length
To straddle the cruciate ligament
4mm wide prongs
21mm wide tips

Wide Prongs PCL Retractor

- 25cm/10" Length
- To straddle the cruciate ligament
- 5mm wide prongs
- 23mm wide tips

SCREWDRIVER INSERTER

		Fat
		Cross-slot
		Phillips small
		Phillips large
		Hexagon 1,5 mm
		Hexagon 2,5 mm
		Hexagon 3,5 mm
		Sechskant 4,5 mm



Screwdriver Handle

Manico per cacciavite



SCREWDRIVER



1:1

Screwdriver

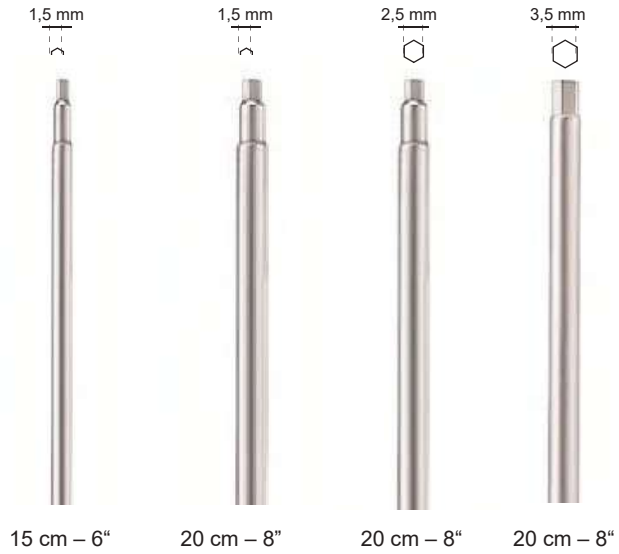

Slotted Head	Long Slotted Head	Phillips Head	Cross Slotted Head
17cm/6¾" length	25cm/10" length	25cm/10" length	25cm/10" length
For head screws- 2.7mm - 4.0mm	For head screws 2.7mm - 4.0mm	For small Phillips head screws 6mm	For cross slot screws 6mm



**K- WIRE
SINGLE END**

6 cm – 2"

10 cm – 4"

12 cm – 4 3/4"

15 cm – 6"

23 cm – 9"

31 cm – 12 1/8"

- Ø 0,8 mm
- Ø 0,9 mm
- Ø 1,0 mm
- Ø 1,1 mm
- Ø 1,2 mm
- Ø 1,3 mm
- Ø 1,4 mm
- Ø 1,5 mm
- Ø 1,6 mm
- Ø 1,7 mm
- Ø 1,8 mm
- Ø 1,9 mm
- Ø 2,0 mm
- Ø 2,2 mm
- Ø 2,4 mm
- Ø 2,5 mm
- Ø 3,0 mm



**K- WIRE
DOUBLE END**

6 cm – 2 3/8"

10 cm – 4"

12 cm – 4 3/4"

15 cm – 6"

31 cm – 12 1/8"

- Ø 0,8 mm
- Ø 0,9 mm
- Ø 1,0 mm
- Ø 1,1 mm
- Ø 1,2 mm
- Ø 1,3 mm
- Ø 1,4 mm
- Ø 1,5 mm
- Ø 1,6 mm
- Ø 1,7 mm
- Ø 1,8 mm
- Ø 1,9 mm
- Ø 2,0 mm
- Ø 2,2 mm
- Ø 2,5 mm
- Ø 3,0 mm

Ø 12 mm



Kirschner

19 cm – 7 1/2"

32 cm – 12 1/2"

for wires up to:

18 cm

31 cm

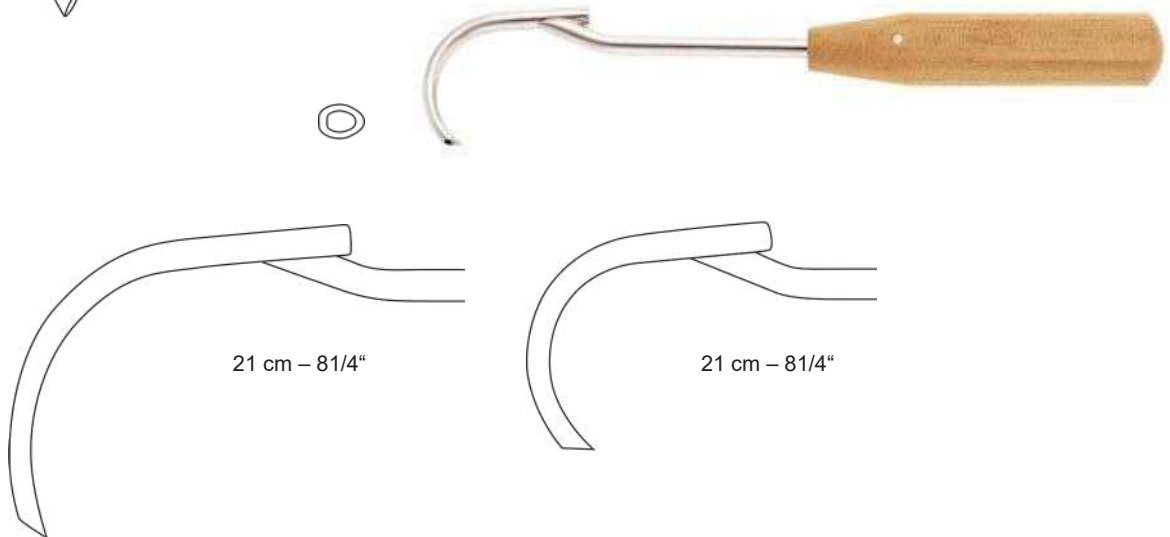
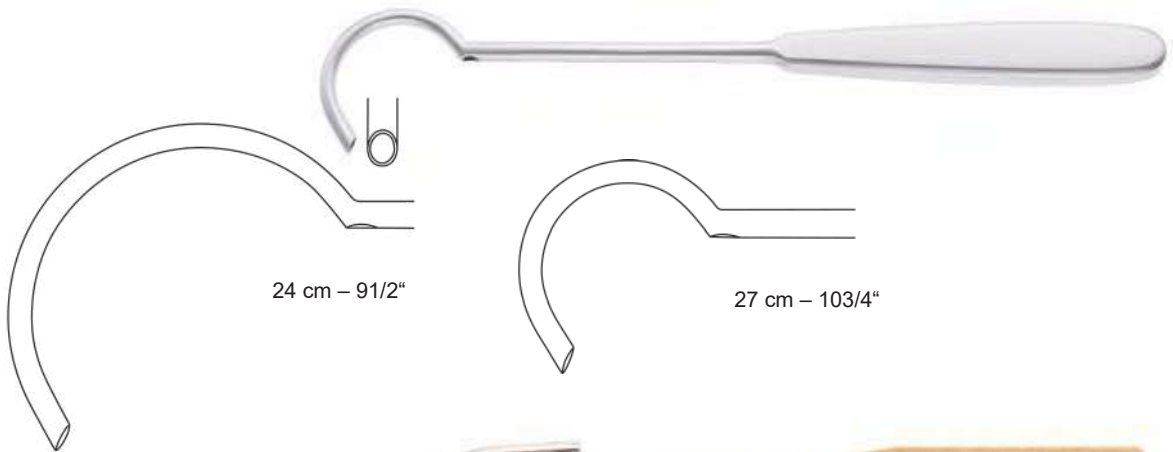
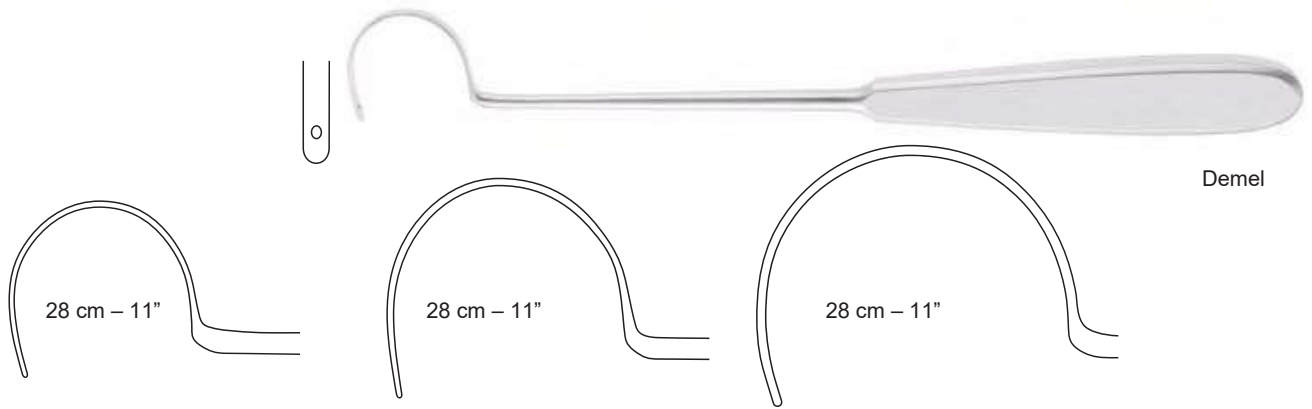

WIRES GUIDES & NOSE PLIERS



22 cm – 8 3/4"

Loupe



28 cm – 11"

Demel



17 cm – 6 3/4"



17 cm – 6 3/4"

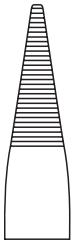

19 cm – 7 1/2"



Nose plier



14 cm – 5 1/2"



Universal

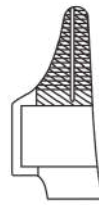

15 cm – 6"



Muller Claus Pullers
18cm/7" Double action



2mm
4mm
6mm

WIRES CUTTER & TWISTING PLIERS



20 cm – 8"

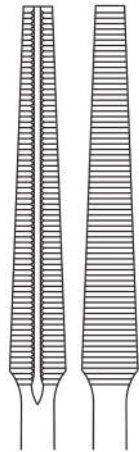

22 cm – 8 3/4"

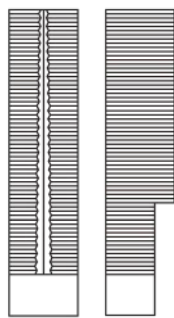

18,5 cm – 7 1/4"

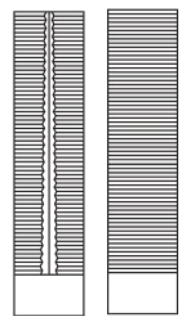

18 cm – 7 1/8"



WIRE CUTTER



19 cm – 7 1/2"

1,6 mm 2,0 mm

"HM"

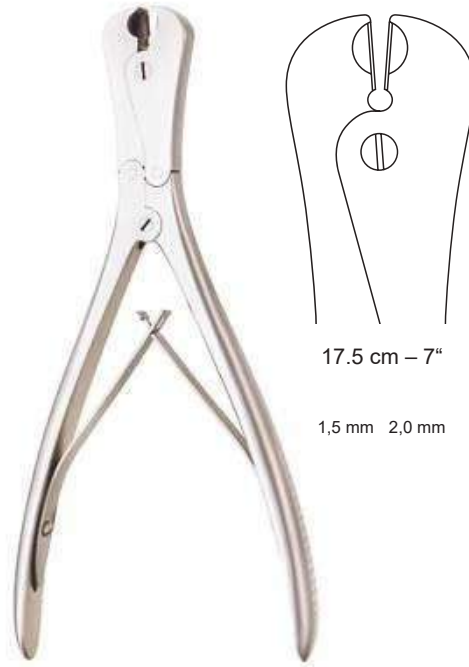

17.5 cm – 7"

1,5 mm 2,0 mm



16 cm – 6 1/4"

1,5 mm 2,0 mm



21,5 cm – 8 1/2"

2,5 mm

"HM"



23 cm – 9"

2,5 mm

"HM"



18,5 cm – 7 1/4"

1,6 mm

WIRES CUTTER & TWISTING PLIERS



26 cm – 10 1/4"

3,0 mm



45 cm – 17 3/4"

6,0 mm

SAWS



Plaster saw

15 cm – 6"



Engel

23 cm – 9"



1:3

29 cm – 113/8"

Satterlee



1:3

35 cm – 133/4"
complete with:

FINGER Langenbeck

Charrière

PLASTER SPREADER & SCISSORS



HAND DRILLS & ACCESSORIES



for twist drills up to Ø 4 mm,
for wires up to Ø 3 mm

Bunnell



Brace only

Stille-Sherman



for twist drills up to Ø 7 mm,
for wires up to Ø4 mm

Ralk



Tightening wrench only

Twist drills



1 – Ø 2,5 mm # 2 – Ø 3 mm # 3 – Ø 3,5 mm # 4 – Ø 4 mm



5 – Ø 10 mm
Trephine

Burrs



6 – Ø 5 mm # 7 – Ø 8 mm # 8 – Ø 12 mm # 9 – Ø 16 mm

Twist drills



Ø 1,5 mm	70cm – 2/4" ³
Ø 2,0 mm	8,5 cm – 33/8"
Ø 2,5 mm	9,5 cm – 33/4"
Ø 3,0 mm	10,0 cm – 4"
Ø 3,2 mm	10,0 cm – 4"
Ø 3,5 mm	11,0 cm – 43/8"
Ø 4,0 mm	12,0 cm – 43/4"
Ø 4,5 mm	13,0 cm – 51/8"
Ø 5,0 mm	13,0 cm – 51/8"
Ø 6,0 mm	14,0 cm – 51/2"

INSTRUMENTS SET FOR BURR HOLE

HUDSON
BRACE HANDLE



HUDSON
BRACE COMPLETE SET
CONSISTING OF: 7 PIECES



A



B



C D



**HYGIENIC LUMBAR AND CERVICAL
KERRISON LAMINECTOMY
RONGEURS**

KERRISON PUNCH



**HYGIENIC LUMBAR AND CERVICAL
KERRISON LAMINECTOMY
RONGEURS**

RONGEURS





FERRIS-SMITH RONGEURS 7"



LENGTH	SIZE	STRAIGHT	UP	DOWN
7"	2mm			
	3mm			
	4mm			
	5mm			

SPINAL IVD RONGEURS BAYONET SHAPED (UP,RIGHT & LEFT) WORKING LENGTH 7"

UPWARD BAYONET SHAPE

RIGHT BAYONET SHAPE

LEFT BAYONET SHAPE



Size	STRAIGHT	UP	Straight	UP	Straight	UP
2mm						
3mm						
4mm						



2mm
3mm
4mm

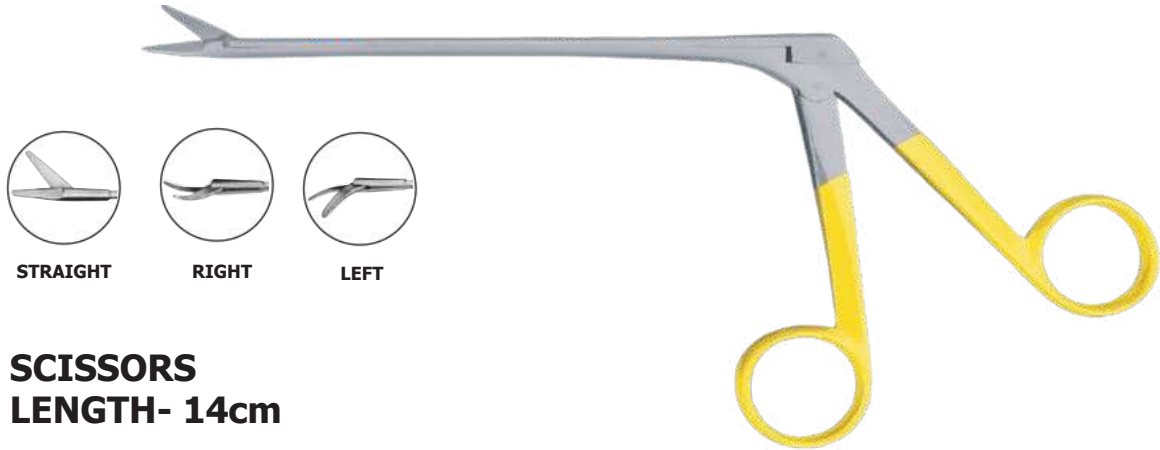



STRAIGHT **RIGHT** **LEFT**

SCISSORS
LENGTH- 14cm

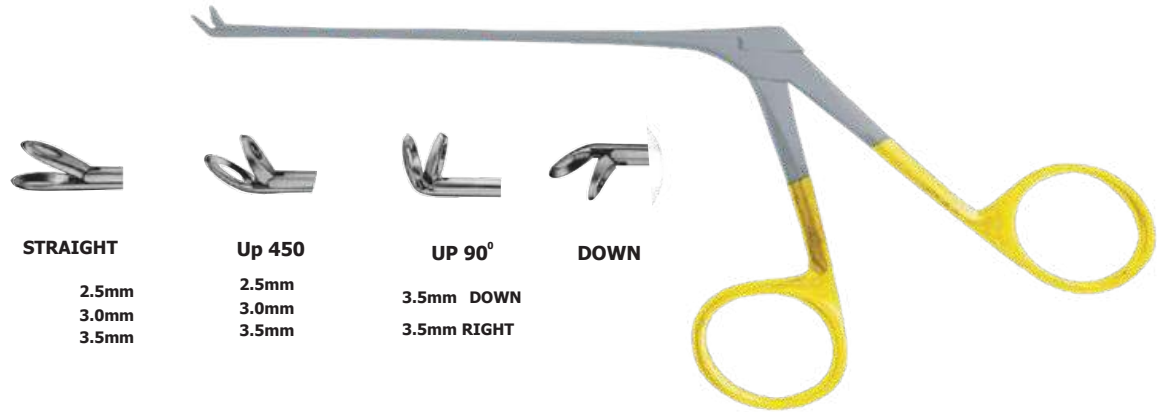







STRAIGHT **Up 45°** **UP 90°** **DOWN**

13 CM 2.5mm
13 CM 3.0mm
13 CM 3.5mm

20 C
M 2 0
C M

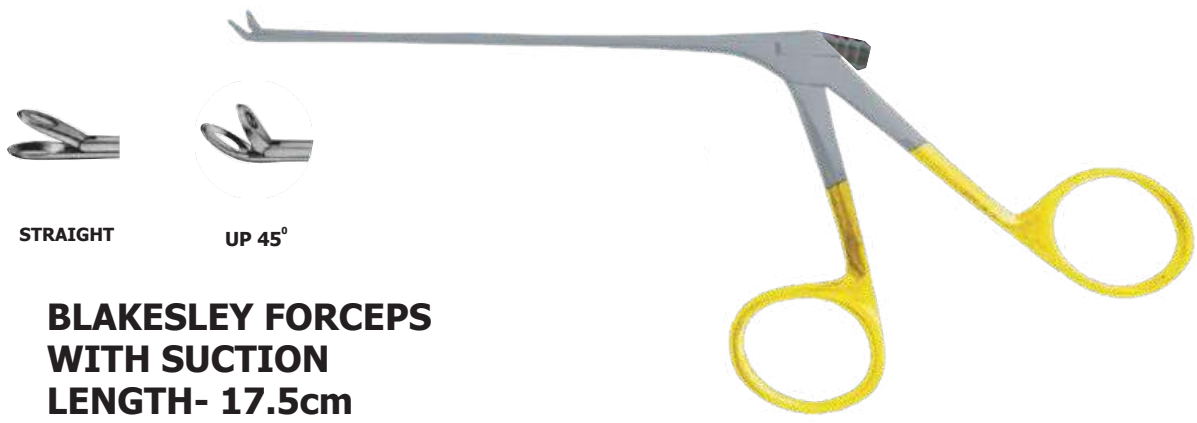
BLAKESLEY FORCEPS
LENGTH- 13cm & 20cm



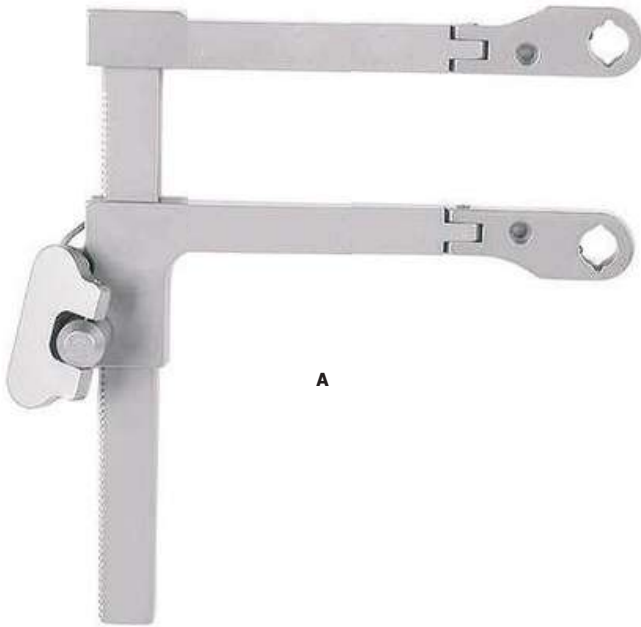

STRAIGHT **UP 45°**

BLAKESLEY FORCEPS
WITH SUCTION
LENGTH- 17.5cm



A



d



A



B

TRANSVERSAL BASIC RETRACTOR

CERVICAL RETRACTOR SINGLE HINGED

(BLACK COATED)

(BLACK COATED)

MEDICAL TOOTHED BLADES LATERAL SERRATED BLADES

STAINLESS STEEL
23 mm, WIDTH (BLACK COATED)

STAINLESS STEEL
23 mm, WIDTH (BLACK COATED)

LENGTH

- 40mm
- 45mm
- 50mm
- 55mm
- 60mm
- 65mm

LENGTH

- 40mm
- 45mm
- 50mm
- 55mm
- 60mm
- 65mm

RONGEURS



CERVICAL RETRACTOR SINGLE HINGED 6 1/2"



LONGITUDINAL CERVICAL RETRACTOR
SINGLE HINGED (BLACK COATED)

D
D

CERVICAL RETRACTOR DOUBLE HINGED
(BLACK COATED) 8"



TRANSVERSAL BASIC RETRACTOR

CASPAR FORCEPS
FOR CHANGING THE BLADES



D



F



A
CLOLOWWARADD-T-YTPYEPE
VERTEBRA SPREADERS

DB
CLOWNGAERDLA MLAINMAINA
SPREADERS



C
LNGE LAMINA
SPREADERS

**VERTEBRA AND LAMINA
SPREADERS**

RETRACTOR



4 PRONGS

B

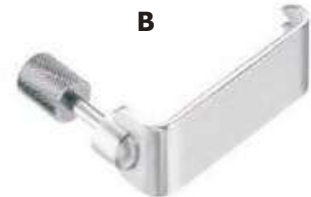

TOOTHED

C



HOOK SHAPED BLUNT

D

SCOVILLE

HAVERFIELDHEMLECTOMY RETRACTOR
N - 10297

VERTEBRAL COLUMN RETRACTORS

BLADES

- 41mmx38mm
- 66mmx48mm
- 48mmx51mm
- 63mmx63mm
- 82mmx58mm

BLADES

- 63mm x 26mm
- 66mm x 30mm
- 89mm x 26mm
- 51mm x 51mm
- 63mm x 51mm

BLADES

- 50mm x 5mm
- 75mm x 5mm



SELF-RETAINING RETRACTORS

CONE **RETRACTOR**

LENGTH

16cm 18mm 3x4 PRONGS SHARP
20cm 20mm 3x4 PRONGS SHARP
26cm 27mm 3x4 PRONGS SHARP

16cm 18mm 3x4 PRONGS BLUNT
20cm 20mm 3x4 PRONGS BLUNT
26cm 27mm 3x4 PRONGS BLUNT



A



B



C

SELF-RETAINING RETRACTORS

MINI WEITLANER

RETRACTOR

LENGTH

11cm 16mm 2x3 PRONGS SIMI SHARP
11cm 16mm 2x3 PRONGS BLUNT

WEITLANER STRAIGHT

RETRACTOR

LENGTH

13cm 18mm 3x4 PRONGS SIMI SHARP
16cm 18mm 3x4 PRONGS SIMI SHARP
20cm 21mm 3x4 PRONGS SIMI SHARP
25cm 27mm 3x4 PRONGS SIMI SHARP
20cm 21mm 4x5 PRONGS SIMI SHARP

LENGTH

13cm 18mm 3x4 PRONGS BLUNT
16cm 18mm 3x4 PRONGS BLUNT
20cm 21mm 3x4 PRONGS BLUNT
25cm 27mm 3x4 PRONGS BLUNT

WEITLANERCURVED

RETRACTOR

LENGTH

20cm 21mm 3x4 PRONGS SIMI SHARP
25cm 27mm 3x4 PRONGS SIMI SHARP
20cm 21mm 4x5 PRONGS SIMI SHARP

ANDERSON ADSON

CEREBELLARRETRACTOR

LENGTH

20cm 16mm 4x4 PRONGS SIMI SHARP
19cm, 23mm 4x4 PRONG SIMI SHARP



SELF-RETAINING RETRACTORS

RETRACTOR



A



B



C

SELF-RETAINING RETRACTORS

RETRACTOR



A



B



C

SELF-RETAINING RETRACTORS

RETRACTOR



A



B



C

SELF-RETAINING RETRACTORS

RETRACTOR

HIP RETRACTORS
Charnley Initial Incision Retractor Set



Standard depth 50mm
Extra depth 75mm
Extra, extra depth 100mm

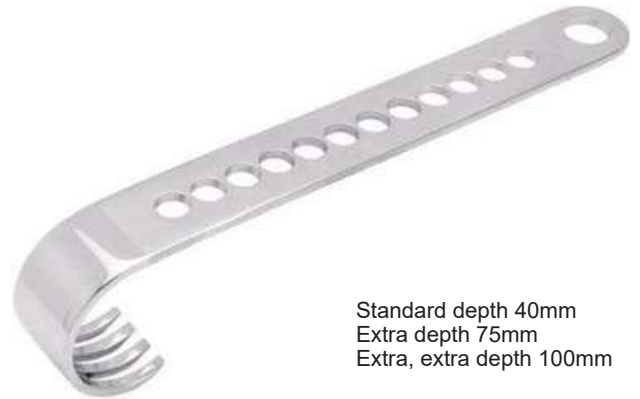

Standard depth 40mm
Extra depth 75mm
Extra, extra depth 100mm



Weight & chain

RETRACTOR

Charnley Horizontal Hip Retractor
28cm/11" length
Blade depth 18mm
Hinged joint
7" opening

OR-762125



Viper Hinged Scoliosis Retractor
30cm/11¾" length
Sharp

Depth Prongs
40mm
70mm
100mm

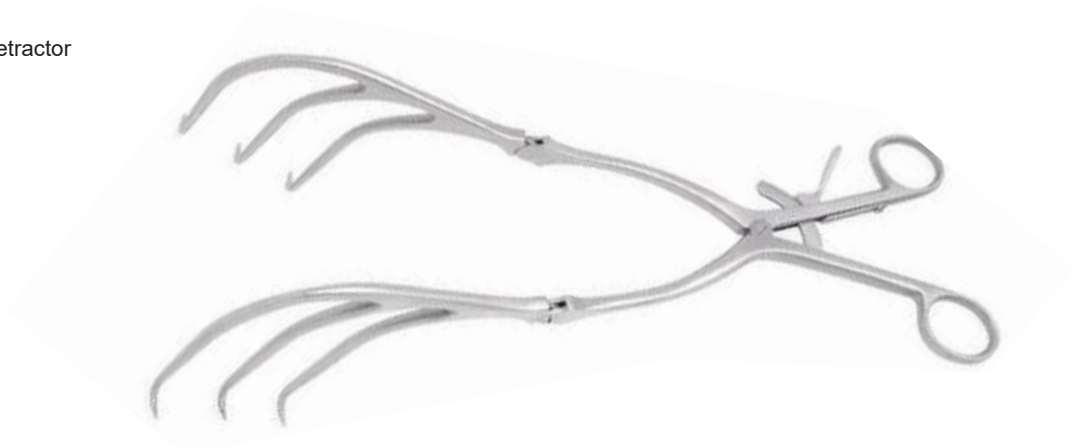

Viper Scoliosis Retractor
30cm/11¾" length
Sharp

Depth Prongs
40mm
70mm
100mm

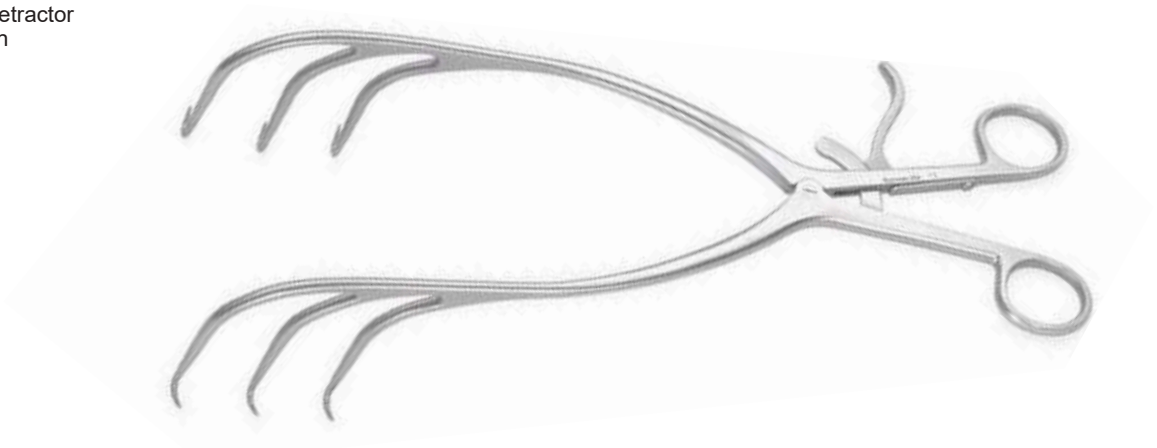

LOVE BAYONET NERVE

ROOT RETRACTOR 21cm

SIZE
4mm



KRAYENBUHL NERVE

ROOT RETRACTOR DOUBLE BAYONET

SIZE
3mm
4mm



CASPAR BAYONET

NERVEROOTRETRACTOR 24cm

SIZE
4mm
6mm



O' CONNELL NERVE

ROOT RETRACTOR 21.5cm LENGTH



LOVER NERVE

ROOTRETRACTOR22cm5mm TIP WIDTH

SIZE
STRAIGHT 5X5mm
25° ANGLED 5X5mm
90° ANGLED 5X5mm



MCCULLOCH NERVE

ROOTRETRACTOR90,6mmTIP
WORKING LENGTH 12.5cm/5"



SH E P P E R ED SUCTION RETRACTOR, FIBER OPTIC ILLUMINATION 4mm Tip, 26cm & 31cm

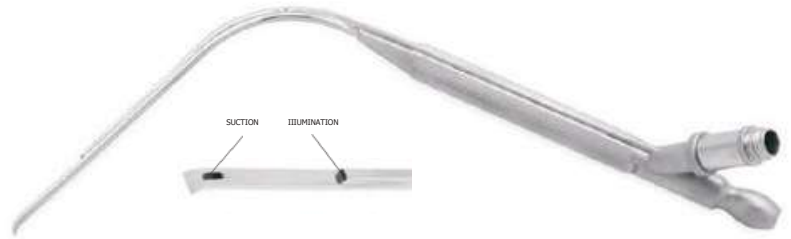

NERVE ROOT RETRACTOR 31cm with SUCTION TIP 7mm Tip

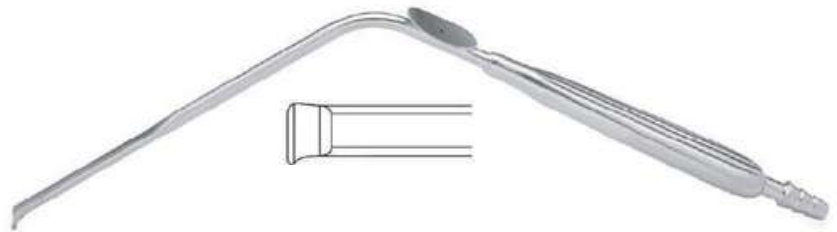

HESS NERVE ROOT RETRACTOR 19cm



HESS NERVE ROOT RETRACTOR 19cm



OBWEGESER DOWN

RETRACTOR 21.5cm LENGTH

SIZE

18 x 5mm
25 x 7mm
35 x 10mm
42 x 10mm
55 x 12mm
70 x 14mm
80 x 16mm



LANGENBECK

RETRACTOR 21.5cm LENGTH

SIZE

25x6mm
35x15m
m
45x20m
m
65x25m
m
75x25m
m
90x25m
m



TAYLOR HIP

RETRACTOR 19cm LENGTH

SIZE

70mm
85mm
100mm



VOLKMANN CATSPA W

RETRACTOR SEMISHARP TEETH

SIZE

3 PRONGS
4 PRONGS
6 PRONGS



15x15mm
3 PRONGS



15x20mm
4 PRONGS



15x30mm
6 PRONGS

CLOWARD STYLE

BLADE RETRACTOR 20cm

SIZE

14mm
18mm
20mm
23mm



RETRACTOR



COTTLE
RETRACTOR
BLUNT



COTTLE
RETRACTOR
SHARP



COTTLE UPPER
RETRACTOR



JOSEPH
RETRACTOR
FINE SHARP



MICRO FINE

3mm

5mm

GILLIES
SKIN HOOK



COTTLE UPPER
TEFION COATED RETRACTOR



ROLLET RETRACTOR
4 SHARP PRONGS



KILNER
RETRACTOR



SHARP



BLUNT



RAGNELL RETRACTOR

16cm

NEEDLE HOLDERS

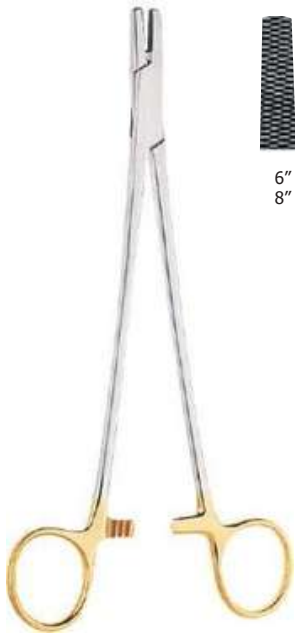

6"
8"

WIRE TWISTER



5"
6"
7"
8"

RYDER NEEDLE HOLDER

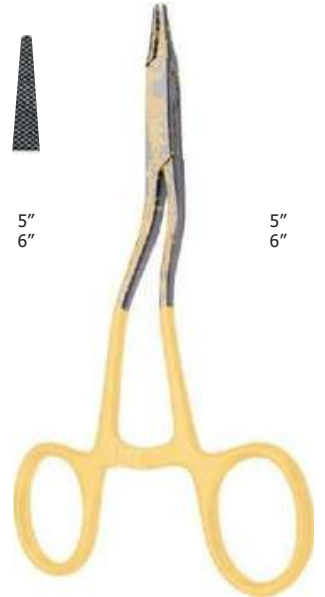

5"
6"

5"
6"

KILNER NEEDLE HOLDER

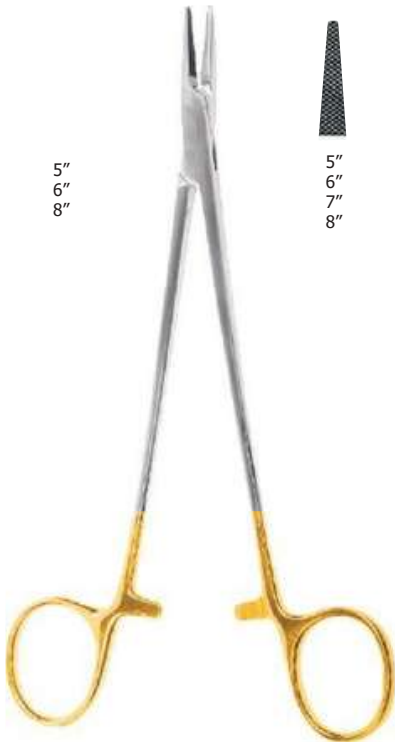

5"
6"
8"



5"
6"
7"
8"

**MICRO VASCULAR NEEDLE
HOLDER**



5"
6"

**MICRO VASCULAR NEEDLE
HOLDER**



OLSEN HAGAR NEEDLE HOLDER

NEEDLE HOLDERS

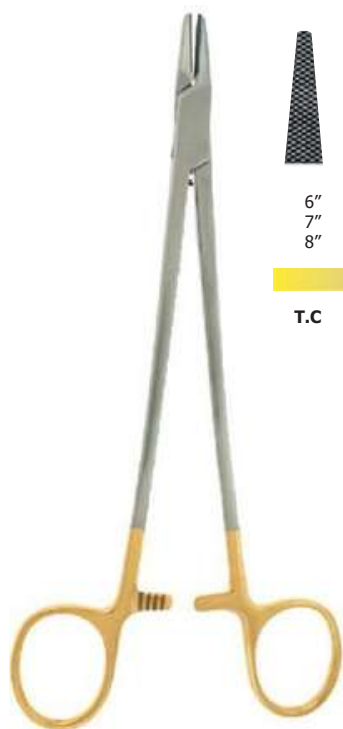

6"
7"
8"



T.C

MAYO HEGAR NEEDLE HOLDER

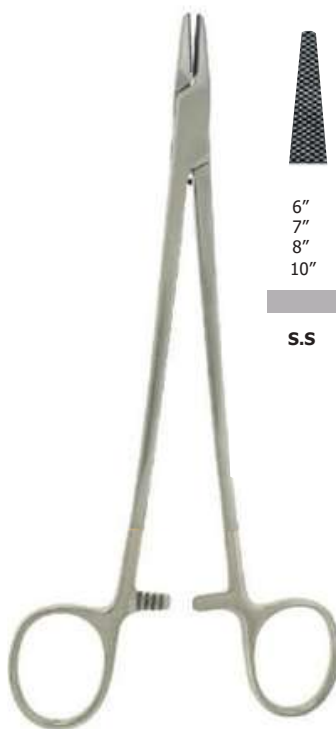

6"
7"
8"
10"



S.S

MAYO HEGAR NEEDLE HOLDER



5 1/2"
8"



T.C

MATHIEU NEEDLE HOLDER

FINE MICRO SPRING NEEDLE HOLDER FLAT HANDLE



NEEDLE HOLDERS



MICRO SPRING NEEDLE HOLDER FLAT HANDLE

**MICRO SPRINGNEEDLE HOLDER ROUND HANDLE
TITANIUM**

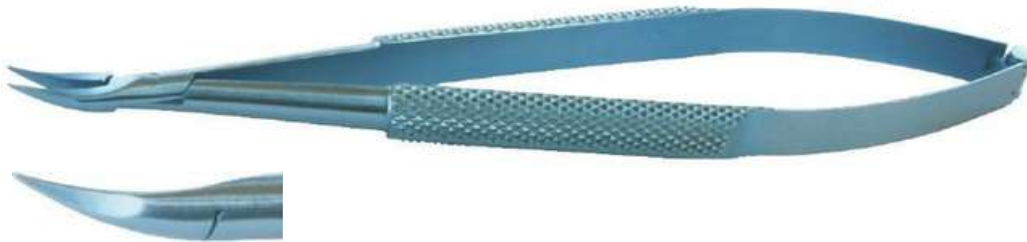

YASARGIL MICRO NEEDLE HOLDER BAYONET SHAPE

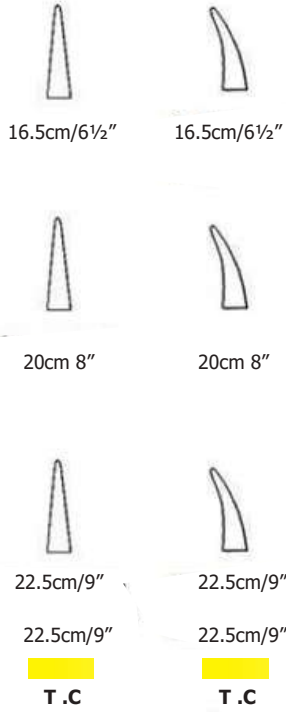

YASARGIL

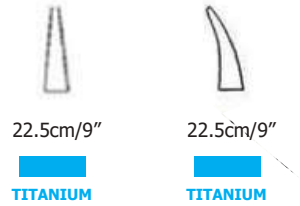

YASARGIL

YASARGIL MICROSCISSORS BAYONET SHAPE



YASARGIL



UPWARD
22.5cm/9"

TITANIUM



STRAIGHT
22.5cm/9"

TITANIUM



DOWNWARD
22.5cm/9"



UPWARD
22.5cm/9"
24.5cm/9¾"

22.5cm/9"
T.C



STRAIGHT
22.5CM
24.5CM
22.5CM
T.C



YASARGIL

MICROS SCISSORS

MICRO SPRING SCISSORS FLAT HANDLE

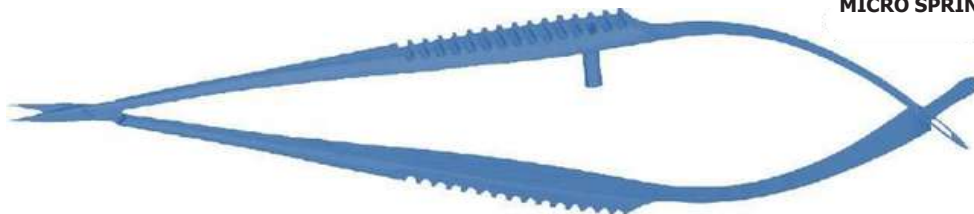

MICRO SCISSORS SPRING ROUND HANDLE



DENNIS MICRO SCISSORS SPRING
STRAIGHT 277-058 CURBED 277-059 DENNIS
MICRO SCISSOR ROUND HANDLE, DOUBLE
ACTION 18.4 cm



SCISSORS



JAMISON METZENBAUM
SCISSORS NARROW TIP BLUNT CURVED

9"
7"
6"



SCHMIEDEN-TAYLOR
DURA SCISSOR 15,5CM, 6"



KELLY SCISSORS
STRAIGHT 6 1/4"



STEVENS SCISSORS
CURVED

4 1/2"

S.S

STEVENS SCISSORS
STRAIGHT

4 1/2"



STEVENS SCISSORS
CURVED

4 1/2"
5 1/2"

T.C

STEVENS SCISSORS
STRAIGHT

4 1/2"
5 1/2"



STEVENS SCISSORS
CURVED

4 1/2"
5 1/2"

S.C

STEVENS SCISSORS
STRAIGHT

4 1/2"
5 1/2"

SCISSORS



KNAPP SCISSORS
CURVED
4½"
S.S

KNAPP SCISSORS
STRAIGHT
4½"
S.S



KNAPP SCISSORS
CURVED
4½"
5½"
T.C

KNAPP SCISSORS
STRAIGHT
4½"
5½"
T.C



KNAPP SCISSORS
CURVED
4½"
5½"
S.C

KNAPP SCISSORS
STRAIGHT
4½"
5½"
S.C



IRIS SCISSORS
CURVED
3½"
4"
5"
S.S

IRIS SCISSORS
STRAIGHT
3½"
4"
5"
S.S



IRIS SCISSORS
CURVED
3½"
4"
5"
T.C

IRIS SCISSORS
STRAIGHT
3½"
4"
5"
T.C



IRIS SCISSORS
CURVED
4"
5"
S.C

IRIS SCISSORS
STRAIGHT
4"
5"
S.C

SCISSORS

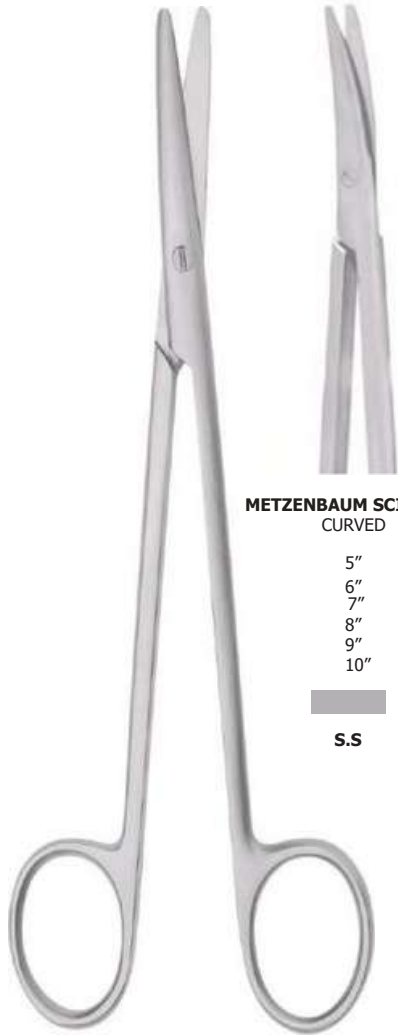

METZENBAUM SCISSORS
CURVED

5"
6"
7"
8"
9"
10"

S.S

METZENBAUM SCISSORS
STRAIGHT

5"
6"
7"
8"
9"
10"

S.S

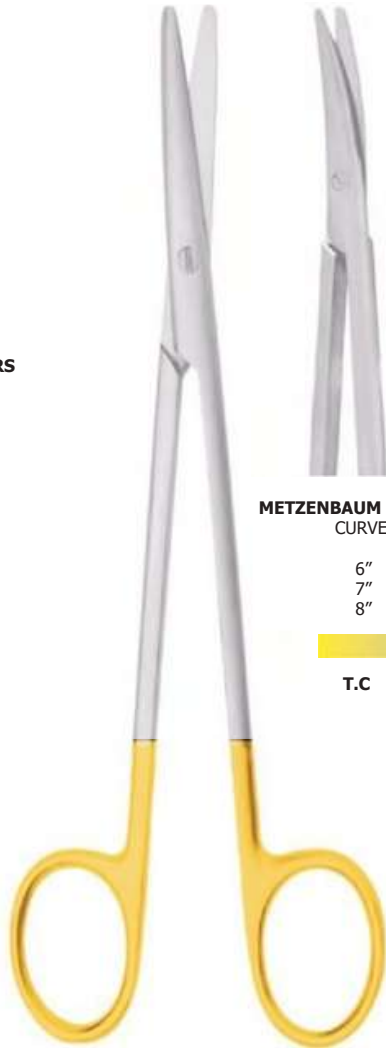

METZENBAUM SCISSORS
CURVED

6"
7"
8"

T.C

METZENBAUM SCISSORS
STRAIGHT

6"
7"
8"

T.C

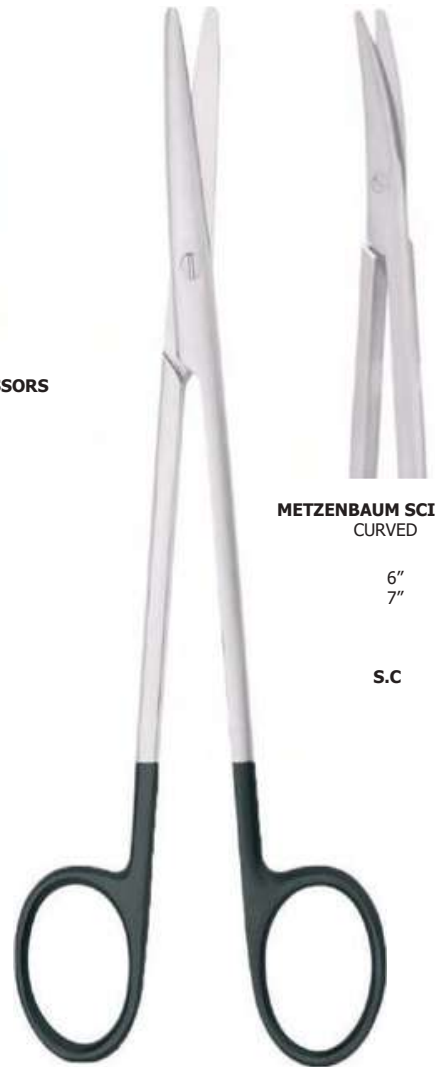

METZENBAUM SCISSORS
CURVED

6"
7"

S.C

METZENBAUM SCISSORS
STRAIGHT

6"
7"

S.C

SCISSORS



MAYO SCISSORS
STRAIGHT

- 5 1/2"
- 6 1/2"
- 7 1/2"
- 8 1/2"
- 9 1/2"
- 10 1/2"



S.S



MAYO SCISSORS
CURVED

- 5 1/2"
- 6 1/2"
- 7 1/2"
- 8 1/2"
- 9 1/2"
- 10 1/2"



S.S

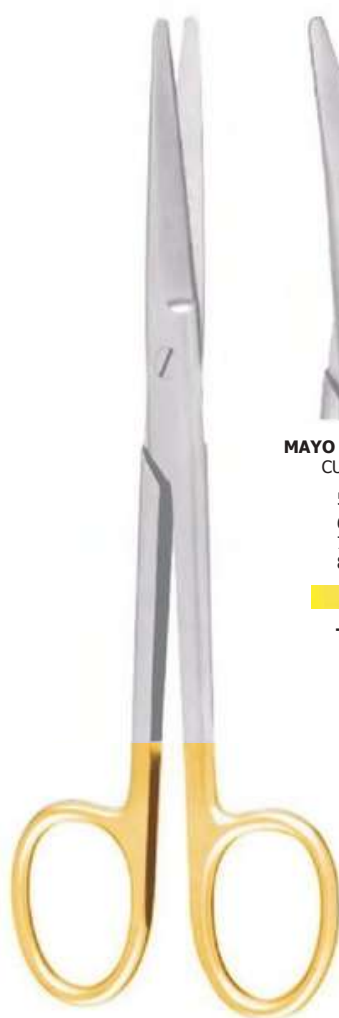

MAYO SCISSORS
STRAIGHT

- 5 1/2"
- 6 1/2"
- 7 1/2"
- 8 1/2"



T.C



MAYO SCISSORS
CURVED

- 5 1/2"
- 6 1/2"
- 7 1/2"
- 8 1/2"



T.C



MAYO SCISSORS
STRAIGHT

- 6 1/2"
- 7 1/2"



MAYO SCISSORS
CURVED

- 6 1/2"
- 7 1/2"

S.C

SCISSORS

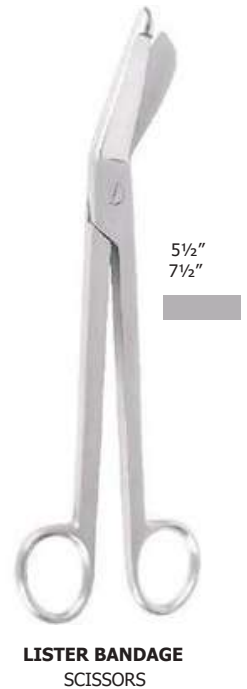
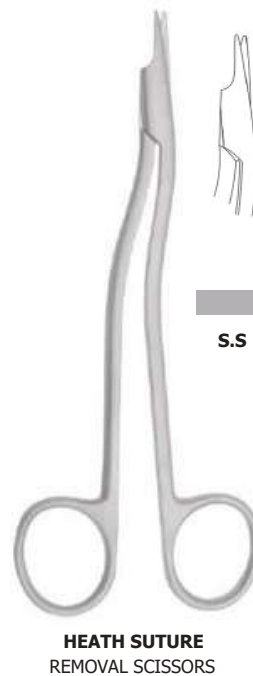
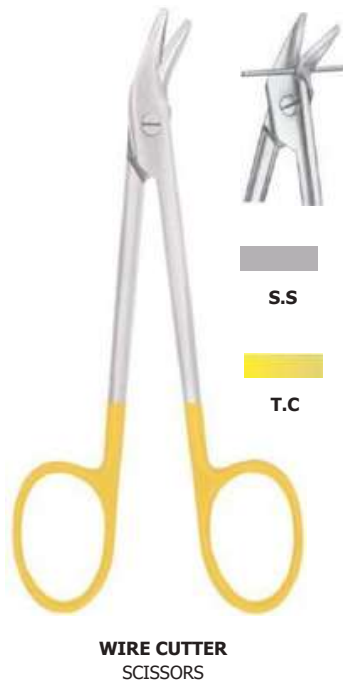
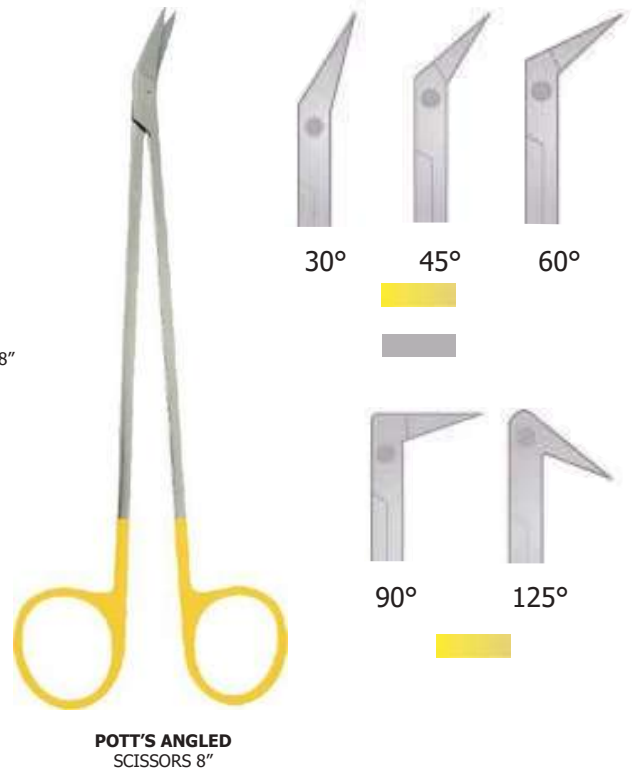

MICRO FORCEPS

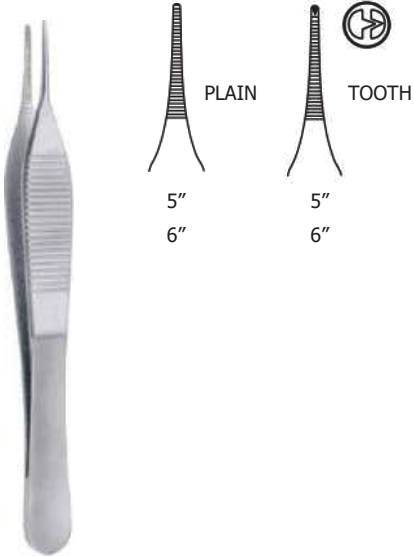

ADSON FORCEPS



ADSON FORCEPS

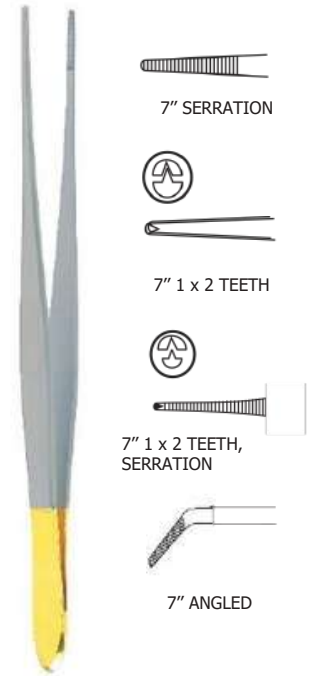

CUSHING FORCEPS SEMI SHARP
DISSECTING END GUTSCH HANDLE

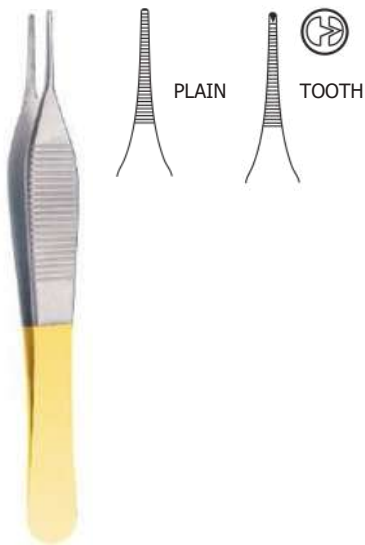

ADSON FORCEPS
PLAIN- 5"
Fine

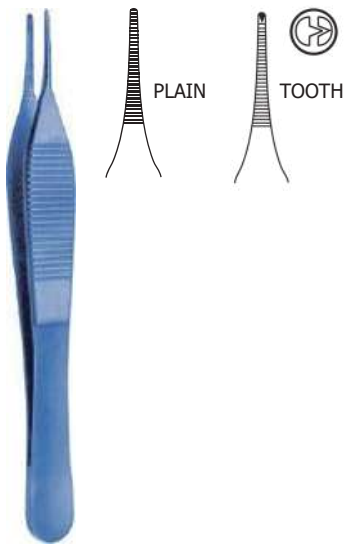

ADSON FORCEPS
PLAIN- 5"
Fine



ADSON BROWN
FORCEPS 5"



BROWN FORCEPS
8 x 8 TEETH

MICRO FORCEPS

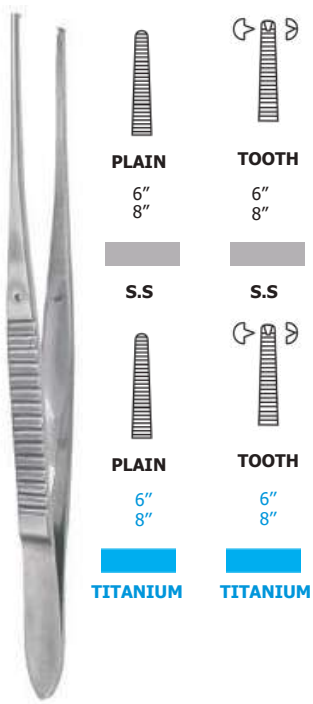

DISSECTION FORCEPS FINE

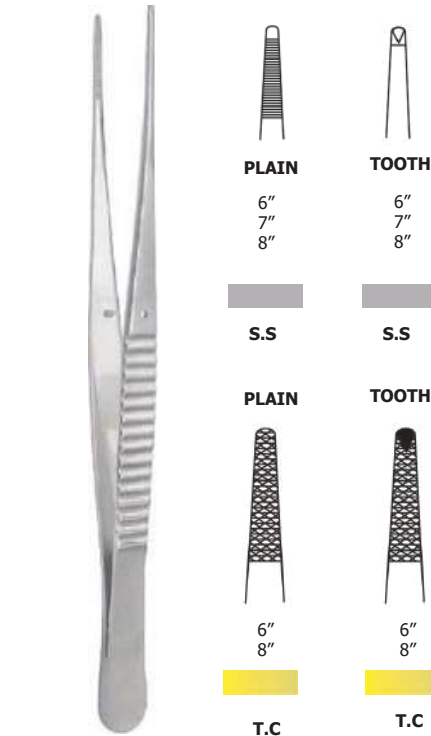

DISSECTING FORCEPS



CROW INSULATED FORCEPS 9" STRAIGHT **MAXWELL FORCEPS 9" CURVED**

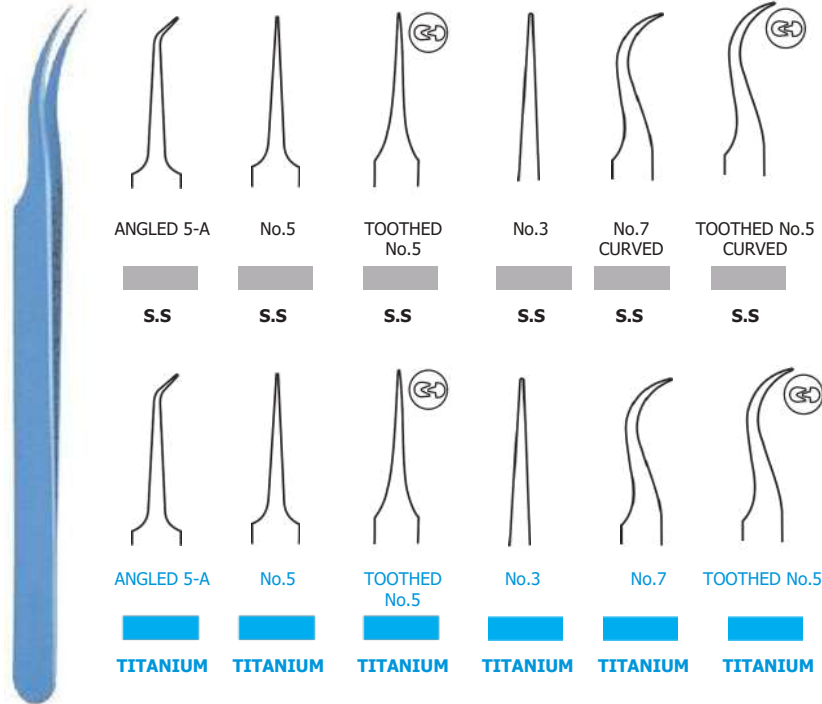

MICRO JEWELLERS FORCEPS

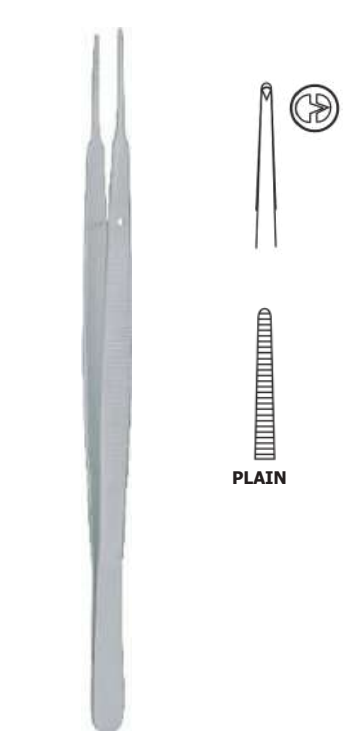

GERALD FORCEPS STRAIGHT NARROW 7"

MICRO FORCEPS



PLAIN STRAIGHT	PLAIN CURVED	TEETH	TEETH CURVED	
6"	6"	6"	6"	S.S
8"	8"	8"	8"	
6"	6"	6"	6" 8"	TITANIUM
8"	8" CURVED	8" TOOTH	TOOTH	
6"	6"			
8"	8"			
DIAMOND	DIAMOND			



PLAIN STRAIGHT	PLAIN CURVED	TEETH	TEETH CURVED	
6"	6"	6"	6"	S.S
8"	8"	8"	8"	
6"	6"	6"	6" 8"	TITANIUM
8"	8" CURVED	8" TOOTH	TOOTH	
6"	6"			
8"	8"			
DIAMOND	DIAMOND			

MICRO FORCEPS ROUND HANDLE PLATFORM TIP

MICRO FORCEPS FLAT HANDLE PLATFORM TIP



JANSEN BAYNOT FORCEPS PLAIN

6"
7"
8"



JANSEN BAYNOT FORCEPS PLAIN 6"



JANSEN BAYNOT FORCEPS 1x2 TOOTH

6"
8"



WILDE AURAL FORCEPS



NELSON TISSUE FORCEPS



6"
8"

BLADE & HANDELS



B.P. Handle 3
LONG HANDLE
B.P. Handle 3



B.P. Handle 4
LONG HANDLE
B.P. Handle 4



B.P. Handle 7



ROUND. Handle 3



P-12002
B.P. Handle Curved



VERTICAL CUTTING
HORIZONTAL CUTTING
VERTICAL CUTTING



ROUND HANDLE



No.10



No.11



No.12



No.15



No.21



No.23

BIPOLAR FORCEPS



16 cm
19.5 cm
25 cm

**BIPOLAR COAGULATION
FORCEPS BAYONET TIP-1MM**



16 cm
19.5 cm

**BIPOLAR
COAGULATION
FORCEPS BAYONET TIP-1MM**



16 cm
19.5 cm

**BIPOLAR
COAGULATION
FORCEPS BAYONET TIP-1MM
WITH SUCTION**



16 cm
19.5 cm

**BIPOLAR
COAGULATION TIP-1MM
FORCEPS (ST.)**



16 cm
19.5 cm

**BIPOLAR
COAGULATION TIP-1MM
FORCEPS (ST.)**



16 cm
19.5 cm"

**BIPOLAR
COAGULATION
FORCEPS CURVED TIP-1MM
WITH TWO PINS TIP-1MM**



16 cm
19.5 cm

**BIPOLAR COAGULATION
FORCEPS CURVED
TIP-1MM**



16 cm
19.5 cm

**BIPOLAR
COAGULATION
FORCEPS CURVED TIP-1MM**



16 cm
19.5 cm

**BIPOLAR
COAGULATION
FORCEPS CURVED TIP-1MM
WITH SUCTION**



16 cm
19.5 cm

**BIPOLAR
COAGULATION
FORCEPS CURVED TIP-1MM
WITH TWO PINS**

BLADE & HANDELS



WATSON SKIN
GRAFTING HANDLE

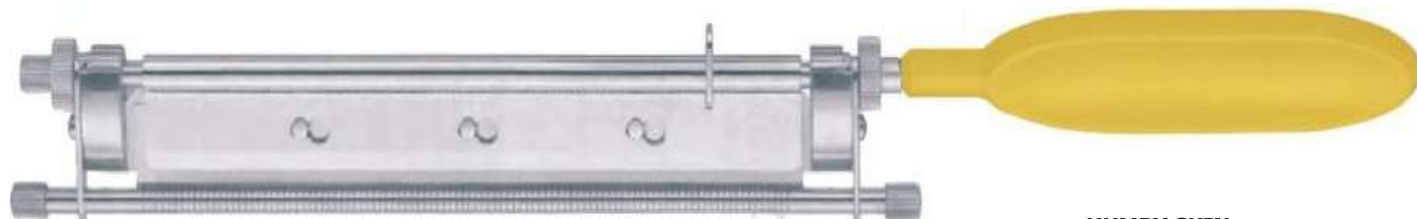

HUMBY SKIN
GRAFTING HANDLE



SKIN GRAFTING
BLADE



SILVER SKIN
GRAFTING KNIFE
FOR SAVING BLADES USE

BIPOLAR FORCEPS, NON-STICK



19.5 cm
25cm
BIPOLAR COAGULATION
FORCEPS BAYONET TIP-1MM



19.5cm
BIPOLAR
COAGULATION
FORCEPS BAYONET TIP-1MM



19.5 cm
BIPOLAR
COAGULATION
BAYONET TYPE TIP-1MM
WITH SUCTION



16 cm
19.5 cm
BIPOLAR
COAGULATION
FORCEPS (ST.) TIP-1MM



16 cm
19.5 cm
BIPOLAR
COAGULATION
FORCEPS (ST.) TIP-1MM



16 cm
19.5 cm
BIPOLAR
COAGULATION
FORCEPS CURVED TIP-1MM



16 cm
19.5 cm
BIPOLAR COAGULATION
FORCEPS CURVED TIP-1MM
WITH TWO PINS



16 cm
19.5 cm
BIPOLAR
COAGULATION
FORCEPS CURVED TIP-1MM



16 cm
19.5 cm
BIPOLAR
COAGULATION
FORCEPS CURVED TIP-1MM
WITH SUCTION



16 cm
19.5 cm
BIPOLAR
COAGULATION
FORCEPS CURVED TIP-1MM
WITH TWO PINS



HEALTHCORE

VENTURES

build.scale.expand.

Unit no 157, Kaliandas Udyog Bhavan, near Century Bazar, Prabhadevi, Mumbai- 400025

Tel: +91 86554 11521

Email: sales@healthcoreventures.com

Web: www.healthcoreventures.com