

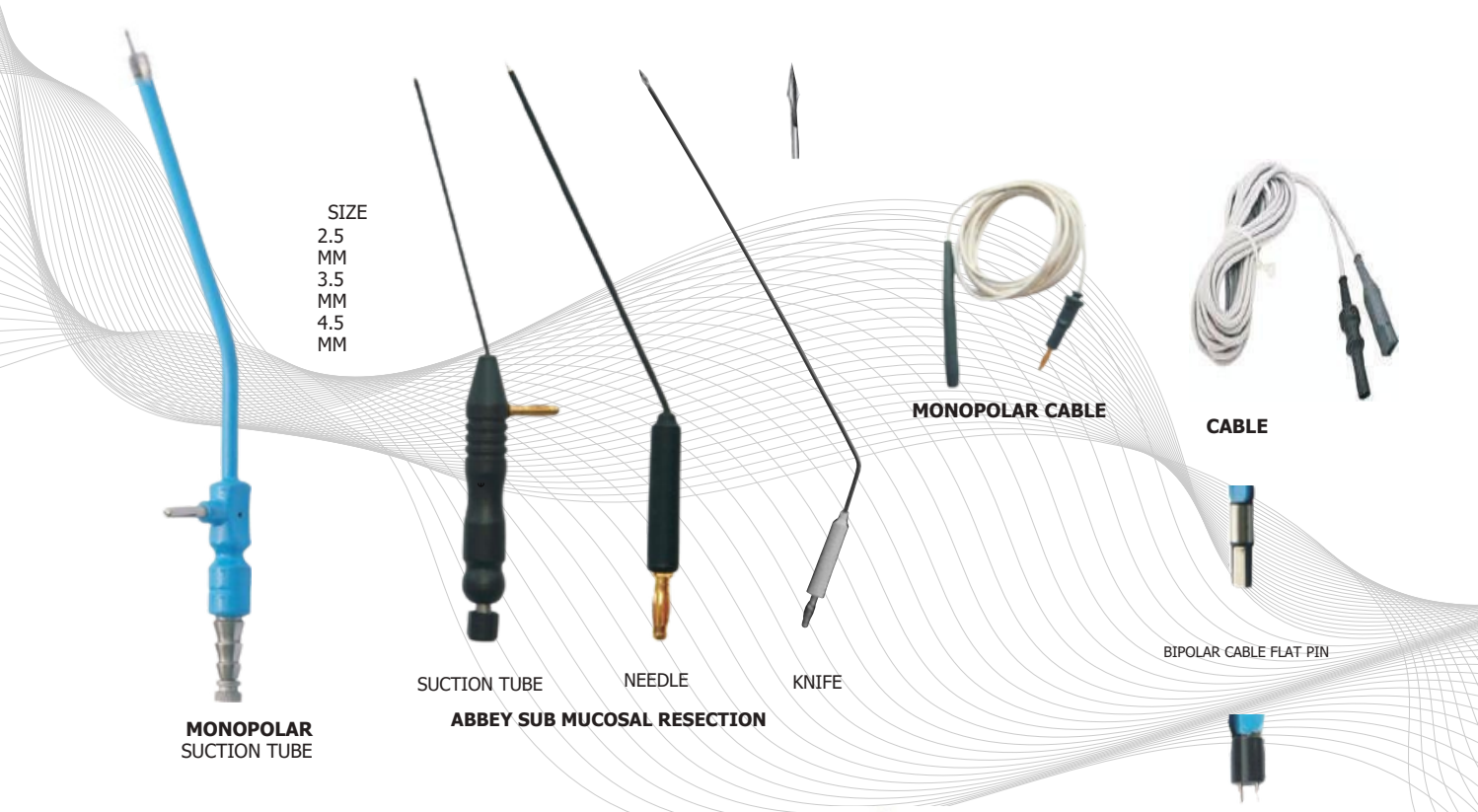

PRODUCT CATALOGUE

General Surgical Instruments

BIPOLAR FORCEPS



SIZE
2.5
MM
3.5
MM
4.5
MM

**MONOPOLAR
SUCTION TUBE**

SUCTION TUBE

ABBEY SUB MUCOSAL RESECTION

NEEDLE

KNIFE

MONOPOLAR CABLE

CABLE

BIPOLAR CABLE FLAT PIN

BIPOLAR CABLE TWO PIN



**ARTERY FORCEPS
STRAIGHT
7"**



**ARTERY FORCEPS
CURVED
7"**



**TURNER WARWICK SCISSORS
STRAIGHT
7"**



**TURNER WARWICK
SCISSORS
CURVED
7"**

GENERAL INSTRUMENTS

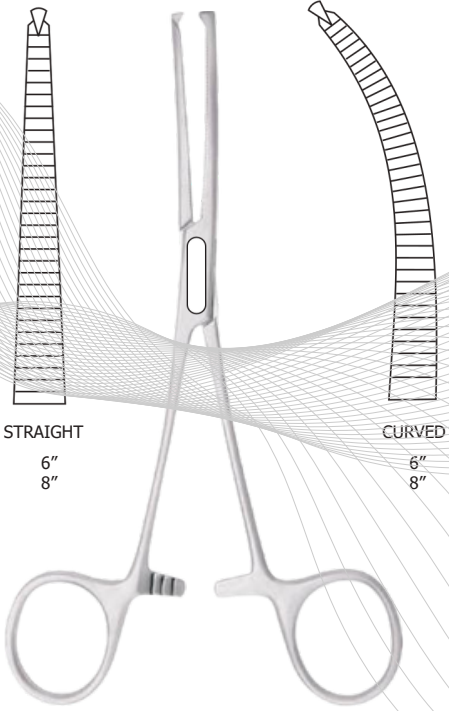

STRAIGHT
6"
8"

CURVED
6"
8"

KOCHER'S
ARTERY FORCEPS
STRAIGHT

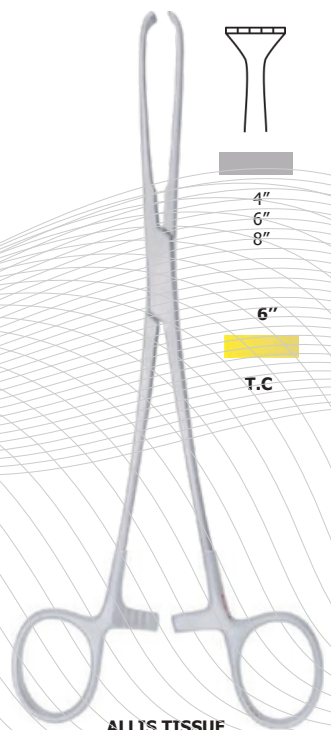

4"
6"
8"
6"
T.C

ALLIS TISSUE
FORCEPS

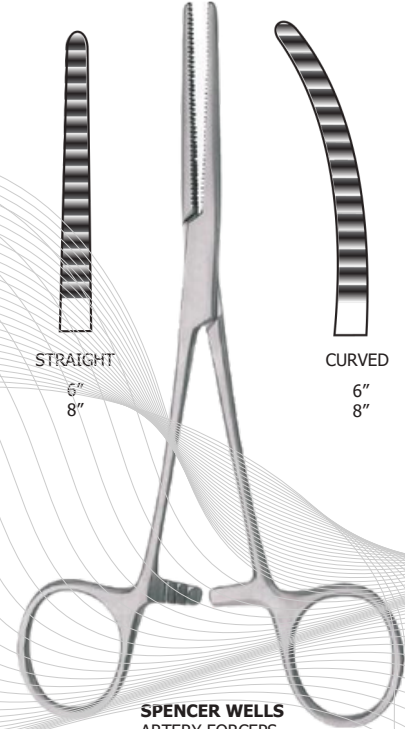

STRAIGHT
6"
8"

CURVED
6"
8"

SPENCER WELLS
ARTERY FORCEPS

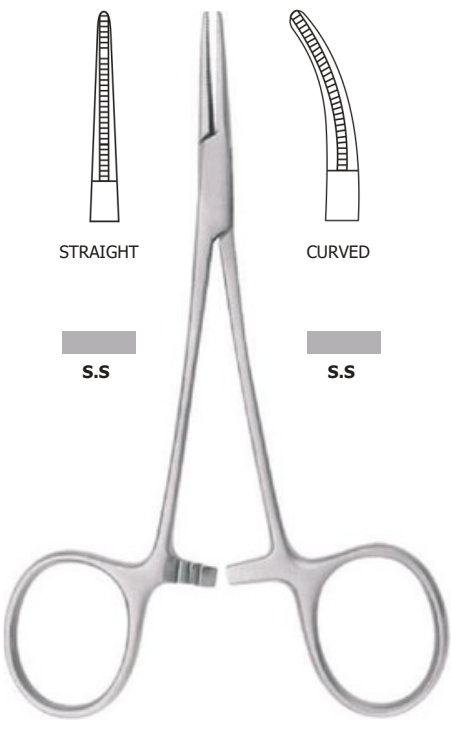

STRAIGHT
S.S

CURVED
S.S

DEBAKEY MOSQUITO FORCEPS
ATRAUMATIC SERRATION

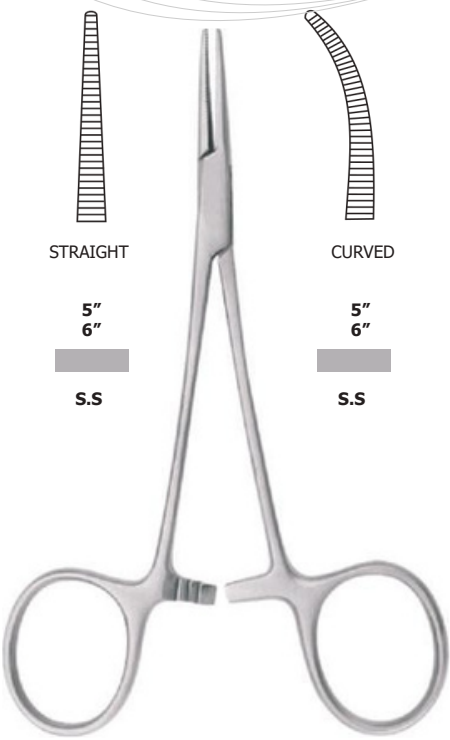

STRAIGHT
5"
6"
S.S

CURVED
5"
6"
S.S

MOSQUITO FORCEPS

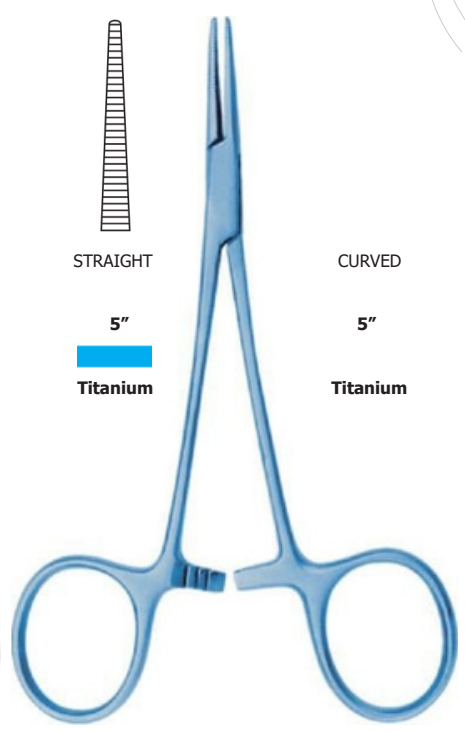

STRAIGHT
5"
Titanium

CURVED
5"
Titanium

MOSQUITO FORCEPS

GENERAL INSTRUMENTS



DANDY SCALP HEMOSTATIC FORCEPS
 CURVED ON SIDE SEERATED 14CM

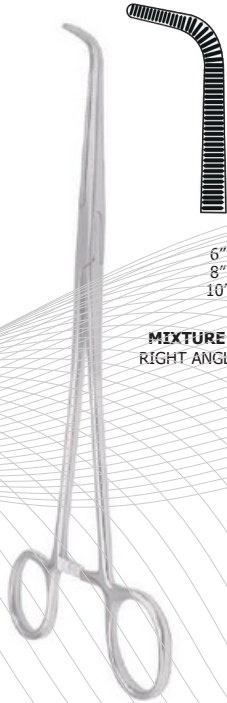

MIXTURE LIGATURE
 RIGHT ANGLED FORCEPS

6"
 8"
 10"

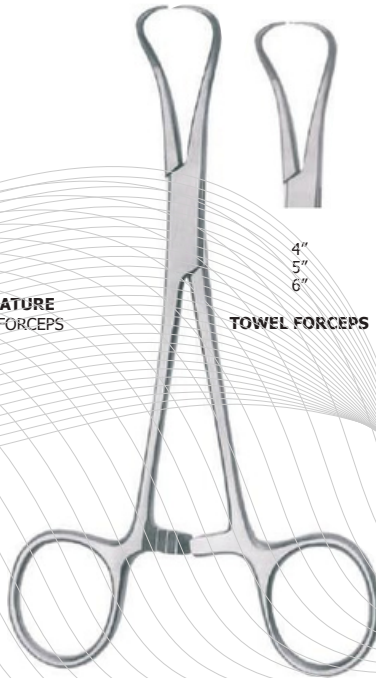

TOWEL FORCEPS

4"
 5"
 6"



TOWEL CLIP
 CROSS ACTION



SPONGE
 HOLDING FORCEPS

8"
 10"



CHEATLE
 JAR



CHEATLE
 FORCEPS

10"

SUCTIONS

SIZE
 2.5 MM
 3.5 MM
 4.5 MM



MONOPOLAR SUCTION TUBE, L-8"

SIZE
 2.0 MM
 2.7 MM
 3.3 MM
 4.0 MM

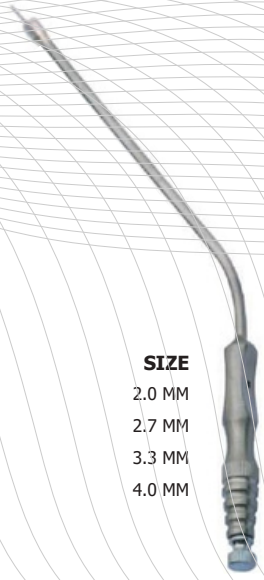

FRAZIER SUCTION TUBES, BALL END, L-8"

SIZE
 1.0 MM
 2.0 MM
 3.0 MM

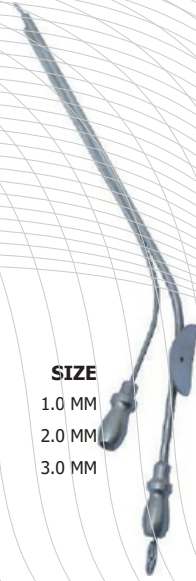

SUCTION IRRIGATION TUBE WITH CHANNEL, 7" TUBES WITH 4 DETACHABLE TIPS



3132 ZOLLNER SUCTION TUBES WITH 4 DETACHABLE TIPS

SIZE
 3 FR
 5 FR
 7 FR
 9 FR
 12 FR

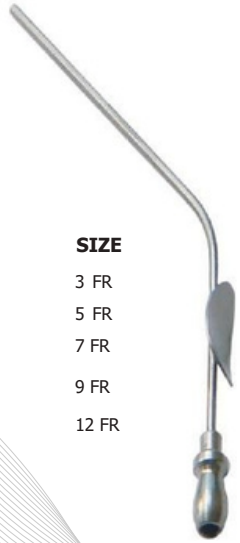

BARRON SUCTION TUBE



CABLE



SIZE
 12
 14
 16
 18
 20
 21
 22
 23
 24

DETACHABLE VERHOEVEN SUCTION TUBES



BRAIN CANNULA SHARP OPEN END WITH BLUNT OBTURATOR

1.5mmx9cm
 2.0mmx9cm
 2.5mmx9cm



BRAIN CANNULA WITH 2 HOLES CLOSE END

1.5mmx9cm
 2.0mmx9cm
 2.5mmx9cm



BRAIN CANNULA WITH 1 HOLES CLOSE END

1.5mmx9cm
 2.0mmx9cm
 2.5mmx9cm



1102 VERHOEVEN SUCTION TUBES ADAPTOR

SUCTIONS

MICRO SUCTION CANNULA
ATRAUMATIC & RIGID SUCTION CANNULA
WITH KEY HOLE, **BLACK COATED**

THE BALL TIP AT THE END OF
THE INSTRUMENT ALLOWS
GENTLE PREPARATION & STABLE
ATRAUMATIC RETRACTION.

WORKING LENGTH
140mm



1.4mm **4FR** 2.0mm **6FR** 2.7mm **8FR 1**

**SUCTION CANNULAS WITH
KEY HOLE**

TOTAL LENGTH

180mm 8"

M

L

205mm 9"

180mm 8"

M

L

205mm 9"

- 4 FR 2.0mm
- 6 FR 2.7mm
- 8 FR 3.3mm
- 10 FR 4.0mm
- 12 FR 4.7mm

**SUCTION CANNULAS WITH
KEY HOLE, BALL ENDED **BLACK COATED****

TOTAL LENGTH

180mm 8"

M

- 4 FR 1.4mm
- 6 FR 2.0mm
- 8 FR 2.7mm
- 10 FR 3.3mm

SUCTION CANNULAS
CURVED SUCTION INSTRUMENTS



WORKING LENGTH
TOTAL LENGTH
OUTER DIAMETER
INNER DIAMETER
ANGLED TIP

135mm 5¼"
200mm 8" 2.7mm
2.0mm RIGHT
ANGLED TIP

135mm 5¼"
200mm 8" 2.7mm
2.0mm LEFT
ANGLED TIP

LIGHT SOURCES & HEADLIGHTS



FIBER OPTIC HEAD LIGHT BAND



LED LIGHTS HEADBAND WITH REACHABLE BATTERY 5 V



HALOGEN FIBER OPTIC COLD LIGHT SOURCE DOUBLE POINT 24V-250 W



HALOGEN FIBER OPTIC COLD LIGHT SOURCE SINGLE POINT 15 V-150 W



FIBER OPTIC CABLE

3.5mm LENGTH 230cm
4.5mm LENGTH 230cm

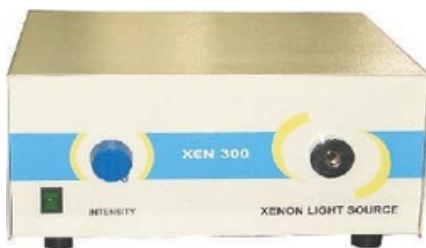

ULTRA COMPACT MINI XENON LIGHT SOURCE 300W



LED LIGHTS SOURCE

TRAYS & DRUMS



SURGICAL TRAY WITH LID
HEAVY STAINLESS STEEL

6" x 9"
7" x 11"
8" x 10"
10" x 12"
12" x 15"



DRESSING DRUMS
SEAMLESS STAINLESS STEEL

6" x 6"
9" x 9"
9" x 11"



MEASURING BOWL

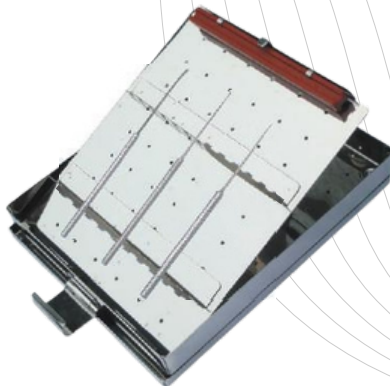

MICRO INSTRUMENT POINTS

90



BOWL
STAINLESS STEEL

3"
4"
5"
6"
8"



KIDNEY TRAY

8"
10"

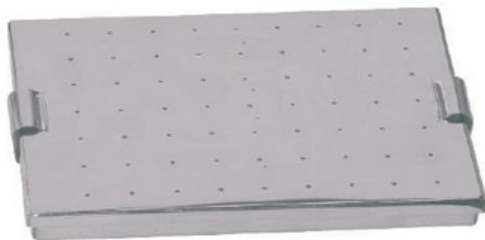

INSTRUMENTS STERILIZING PERFORATOR BOX
STAINLESS STEEL

8" x 4" x 2"
11" x 7" x 2"
12" x 10" x 3"
14" x 10" x 2"



AUTOClave INSTRUMENT BOX
WITH SILICONE MATT
STAINLESS STEEL

8" x 4" x 1"
9" x 8" x 1"
14" x 8" x 1"



HEALTHCORE

VENTURES

build.scale.expand.

Unit no 157, Kaliandas Udyog Bhavan, near Century Bazar, Prabhadevi, Mumbai- 400025

Tel: +91 86554 11521

Email: sales@healthcoreventures.com

Web: www.healthcoreventures.com