



HEALTHCORE
VENTURES
build.scale.expand.

PRODUCT CATALOGUE

Gynecology & Obstetrics
Surgical Instruments

GYNECOLOGY INSTRUMENTS

INDEX

SCISSORS NEEDLE HOLDER MICRO & DISSECTING FORCEPS

GENERAL FORCEPS RETRACTOR

HOOKS

SPECULUM

CANNULAS & CURETTES

DILATORS

SUCTION CANNULAS

**MICRO INSTRUMENTS BLADES & HANDLES BIPOLAR
INSTRUMENTS**

HOLLOWARE

SUCTION MACHINE & LIGHT SOURCE

SCISSORS

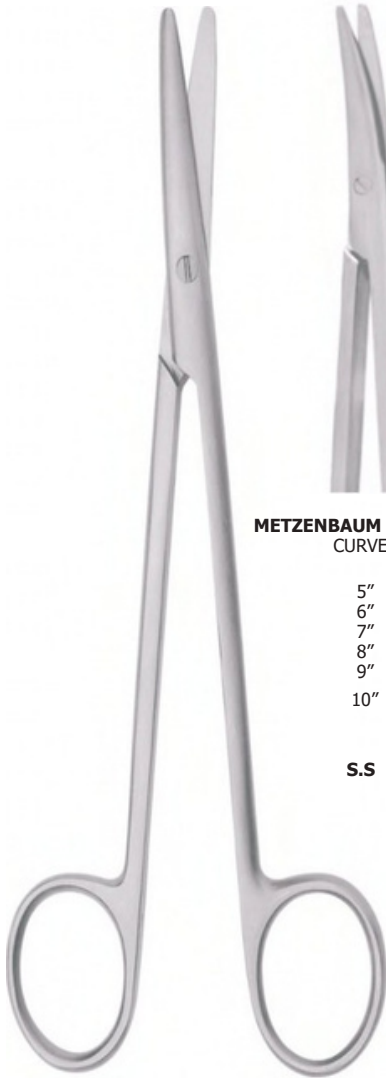

METZENBAUM SCISSORS
CURVED

- 5"
- 6"
- 7"
- 8"
- 9"
- 10"

S.S

METZENBAUM SCISSORS
STRAIGHT

- 5"
- 6"
- 7"
- 8"
- 9"
- 10"

S.S



METZENBAUM SCISSORS
CURVED

- 6"
- 7"
- 8"

T.C



METZENBAUM SCISSORS
STRAIGHT

- 6"
- 7"
- 8"

T.C



METZENBAUM SCISSORS
CURVED

- 6"
- 7"

S.C

METZENBAUM SCISSORS
STRAIGHT

- 6"
- 7"

S.C

SCISSORS



MAYO SCISSORS
STRAIGHT

- 5½"
- 6½"
- 7½"
- 8½"
- 9½"
- 10½"

S.S



MAYO SCISSORS
CURVED

- 5½"
- 6½"
- 7½"
- 8½"
- 9½"
- 10½"

S.S



MAYO SCISSORS
STRAIGHT

- 5½"
- 6½"
- 7½"
- 8½"

T.C



MAYO SCISSORS
CURVED

- 5½"
- 6½"
- 7½"
- 8½"

T.C



MAYO SCISSORS
STRAIGHT

- 6½"
- 7½"

S.C



MAYO SCISSORS
CURVED

- 6½"
- 7½"

S.C

SCISSORS



S.S
5"
6"

T.C
6"



S.S
5"
6"

T.C
6"



S.S
5"
6"

T.C
6"



S.S
5"
6"

T.C
6"



DRESSING SCISSORS
STRAIGHT (SHARP x SHARP)



DRESSING SCISSORS
STRAIGHT (SHARP x BLUNT)



STEVENS SCISSORS
STRAIGHT
4 1/2"

S.S



STEVENS SCISSORS
CURVED
4 1/2"

S.S



STEVENS SCISSORS
STRAIGHT
4 1/2"
5 1/2"

T.C

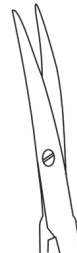

STEVENS SCISSORS
CURVED
4 1/2"
5 1/2"

T.C



STEVENS SCISSORS
CURVED
4 1/2"
5 1/2"

S.C



STEVENS SCISSORS
STRAIGHT
4 1/2"
5 1/2"

S.C

SCISSORS



KNAPP SCISSORS
CURVED
4½"
S.S

KNAPP SCISSORS
STRAIGHT
4½"
S.S



KNAPP SCISSORS
CURVED
4"
5"
T.C

KNAPP SCISSORS
STRAIGHT
4½"
5½"
T.C



KNAPP SCISSORS
CURVED
4"
5"
S.C

KNAPP SCISSORS
STRAIGHT
4½"
5½"
S.C



IRIS SCISSORS
CURVED
3½"
4"
5"
S.S

IRIS SCISSORS
STRAIGHT
3½"
4"
5"
S.S



IRIS SCISSORS
CURVED
3½"
4"
5"
T.C

IRIS SCISSORS
STRAIGHT
3½"
4"
5"
T.C



IRIS SCISSORS
CURVED
4"
5"
S.C

IRIS SCISSORS
STRAIGHT
4"
5"
S.C

SCISSORS

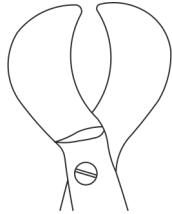

UMBILICAL CORD
 SCISSORS- 4.25"

S.S

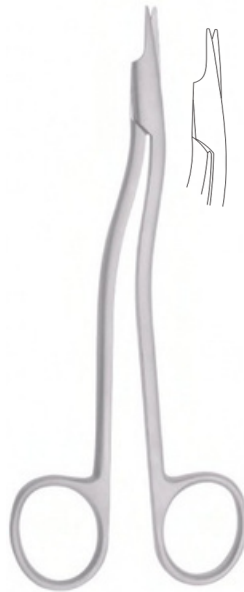

Heath Suture
 REMOVAL SCISSORS

S.S



5 1/2"
 7 1/2"

Lister Bandage
 SCISSORS



EPISIOTOMY
 SCISSORS



Metzenbaum
 FINE TIP Scissors

15cm
 18cm
 20cm

T.C



Gorney
 Face Lift Scissors 19cm
 T.C.

T.C

NEEDLE HOLDER

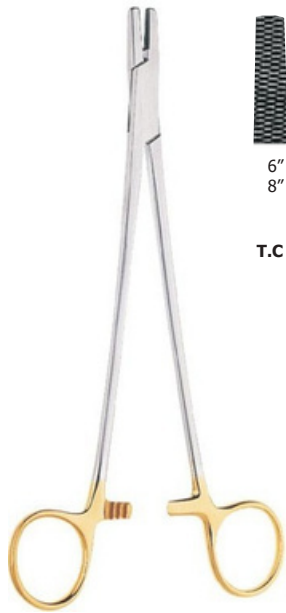

6"
8"

T.C

WIRE TWISTER

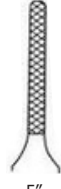
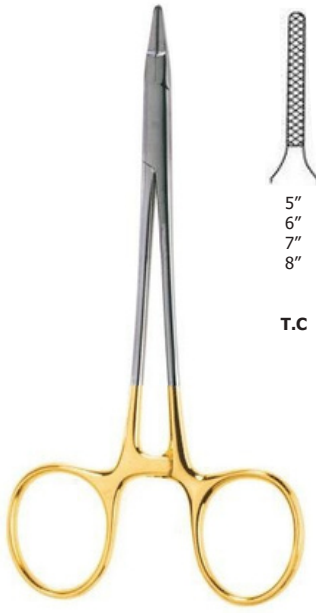

5"
6"
7"
8"

T.C

RYDER NEEDLE HOLDER

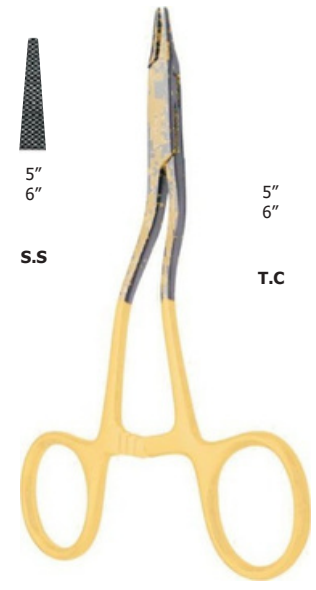

5"
6"

S.S

5"
6"

T.C

KILNER NEEDLE HOLDER

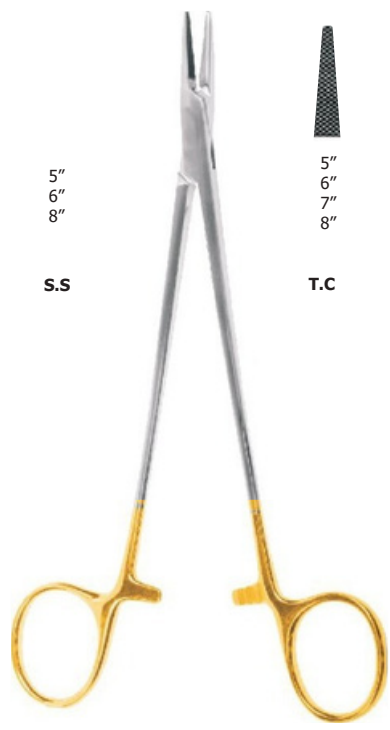

5"
6"
8"

S.S

5"
6"
7"
8"

T.C

MICRO VASCULAR NEEDLE HOLDER



T-18329 5"
T-18081 6"

Titanium

MICRO VASCULAR NEEDLE HOLDER

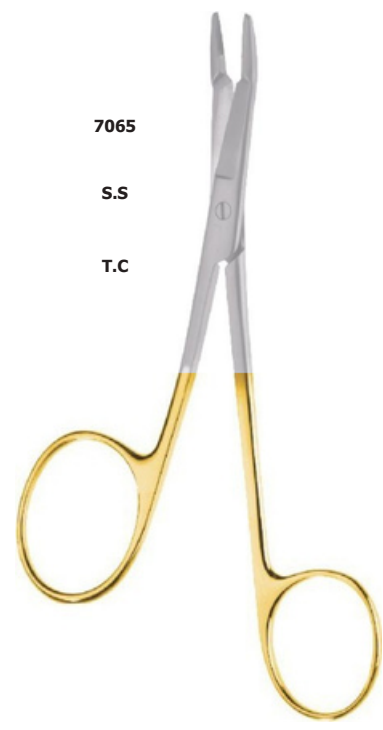

7065

S.S

T.C

OLSEN HAGAR NEEDLE HOLDER

NEEDLE HOLDER

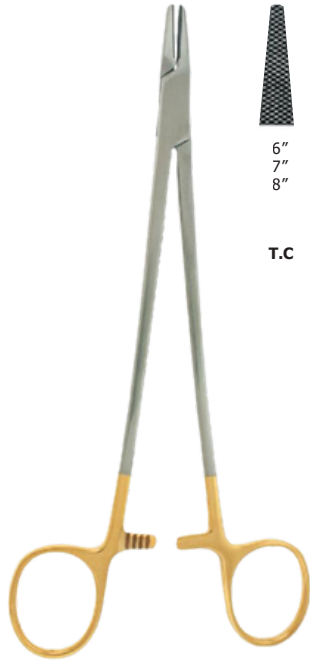

6"
7"
8"

T.C

MAYO HEGAR NEEDLE HOLDER

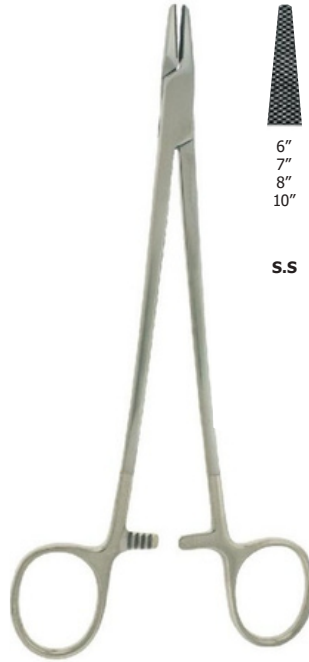

6"
7"
8"
10"

S.S

MAYO HEGAR NEEDLE HOLDER



5 1/2"
8"

T.C

MATHIEU NEEDLE HOLDER



8"

T.C

MAYO HEGAR NEEDLE HOLDER CURVED TIP



8"

8"

T.C

S.S

BOZEMAN NEEDLE HOLDER

MICRO FORCEPS

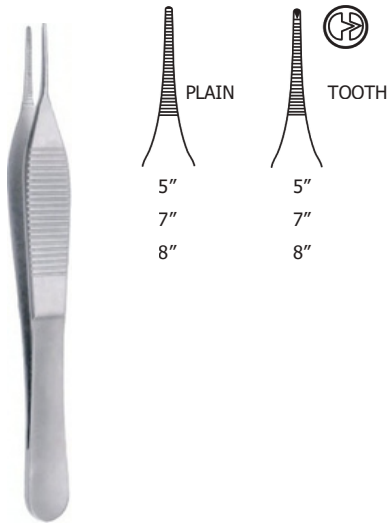

ADSON FORCEPS

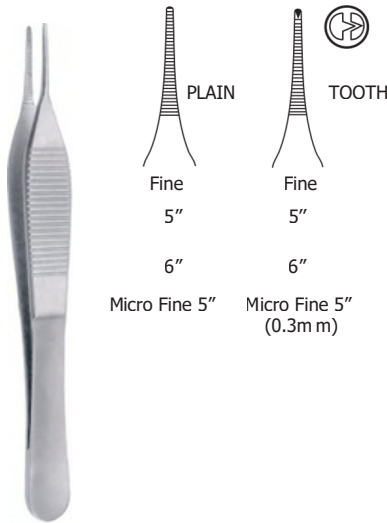

ADSON FORCEPS

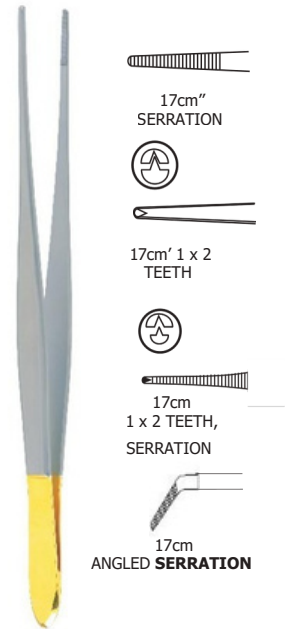

CUSHING FORCEPS SEMI SHARP
DISSECTING END GUTSCH HANDLE

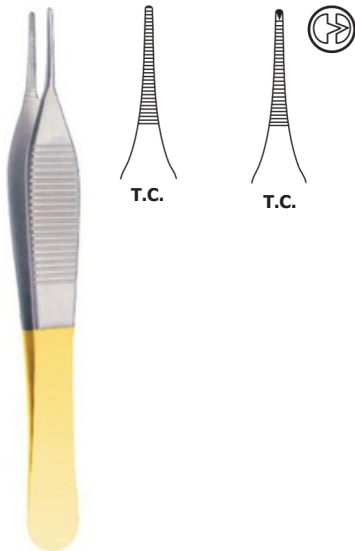

ADSON FORCEPS
PLAIN- 5"
Fine

T.C

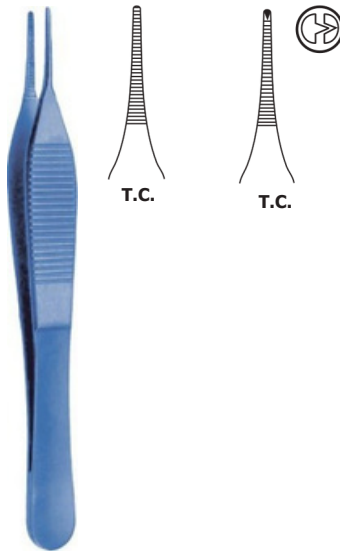

ADSON FORCEPS
PLAIN- 5"
Fine

TITANIUM

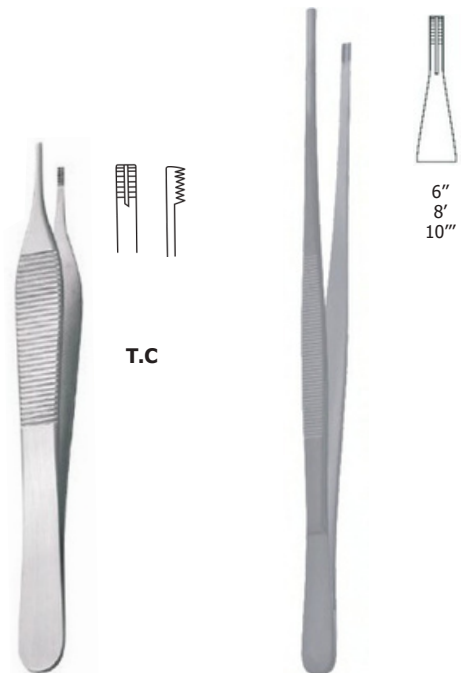

ADSON BROWN
FORCEPS 5"

BROWN FORCEPS
8 x 8 TEE TH

FORCEPS

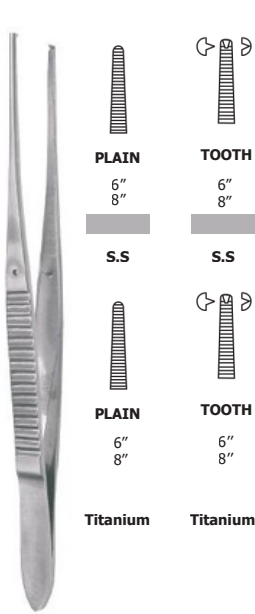

DISSECTION FORCEPS
FINE

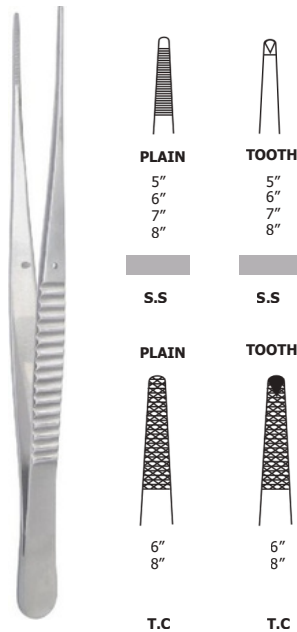

DISSECTING FORCEPS



CROW INSULATED FORCEPS
9" STRAIGHT



MAXWELL FORCEPS
9" CURVED



Debakey Vascular Forceps



STRAIGHT

1.5 mm	2 mm
S.S	S.S
6"	6"
7"	7"
8"	8"

TITANIUM



ANGLED

1.5 mm	2 mm
S.S	S.S
6"	6"
7"	7"
8"	8"

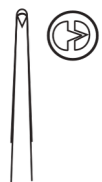

7 1/2"

GERALD FORCEPS
STRAIGHT NARROW 1 X2 TEETH

FORCEPS

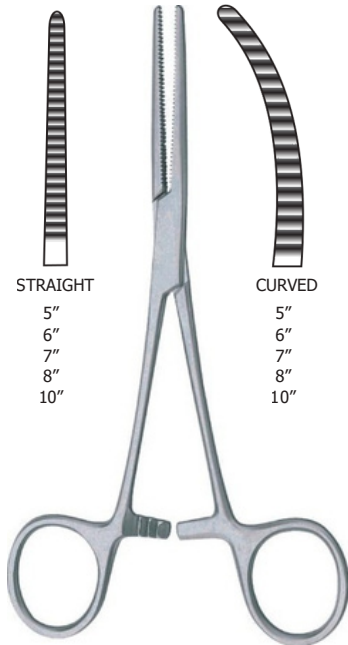

STRAIGHT
 5"
 6"
 7"
 8"
 10"

CURVED
 5"
 6"
 7"
 8"
 10"

ARTERY FORCEPS

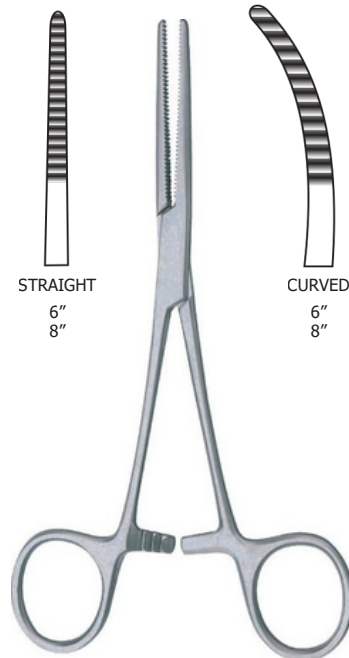

STRAIGHT
 6"
 8"

CURVED
 6"
 8"

KELLY ARTERY FORCEPS

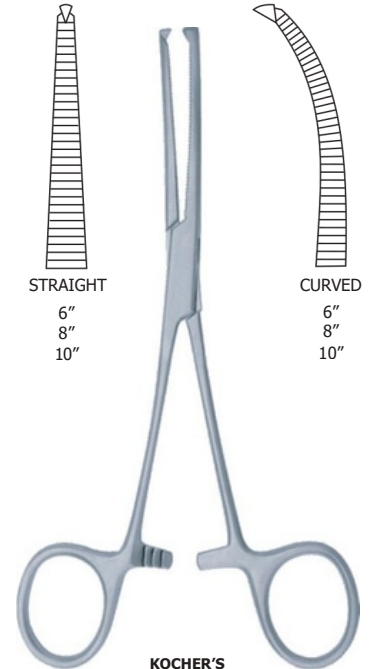

STRAIGHT
 6"
 8"
 10"

CURVED
 6"
 8"
 10"

KOCHER'S ARTERY FORCEPS

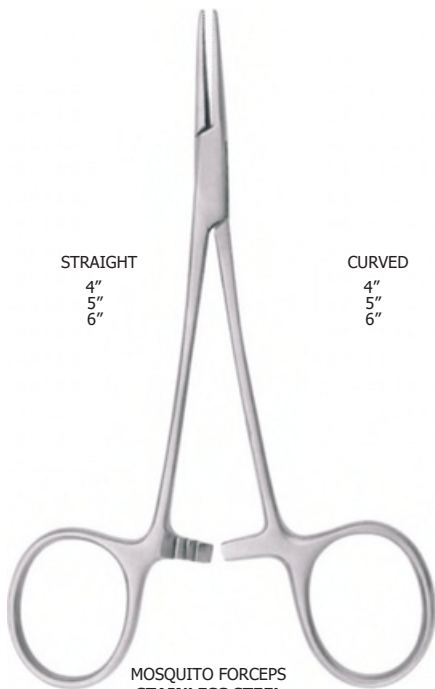

STRAIGHT
 4"
 5"
 6"

CURVED
 4"
 5"
 6"

**MOSQUITO FORCEPS
 STAINLESS STEEL**

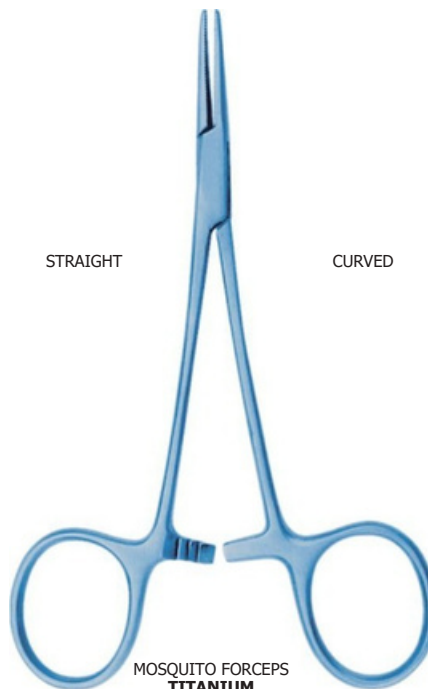

STRAIGHT

CURVED

**MOSQUITO FORCEPS
 TITANIUM**

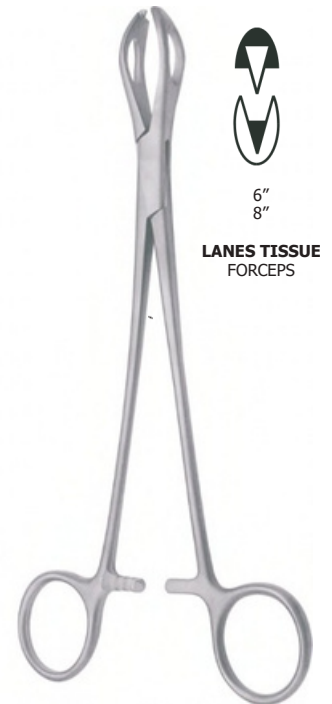

6"
 8"

LANES TISSUE FORCEPS

FORCEPS



ALLIS TISSUE
 GRASPING FORCEPS
 STAINLESS STEEL

4"
 6"
 8"



ALLIS TISSUE
 GRASPING FORCEPS
 TUNGSTEN CARBIDE

6"

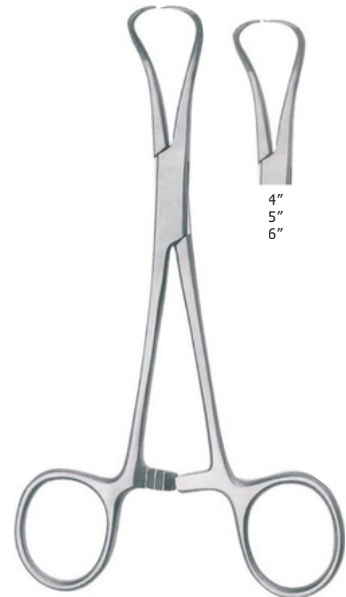

TOWEL FORCEPS
 BACKHAUS

4"
 5"
 6"

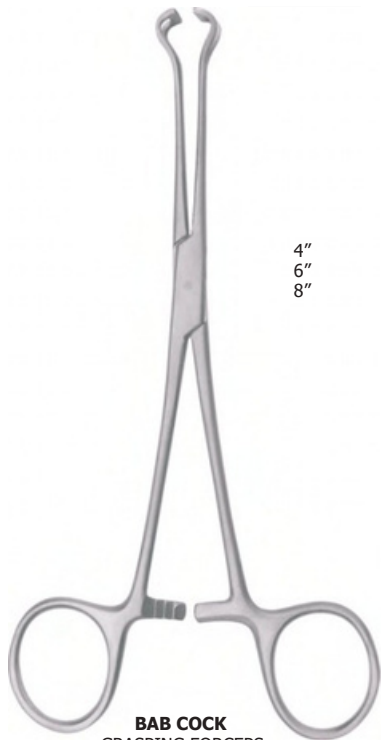

BAB COCK
 GRASPING FORCEPS
 STAINLESS STEEL

4"
 6"
 8"

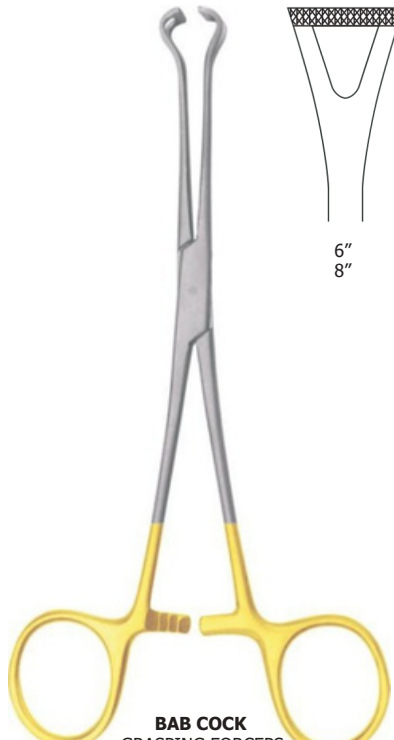

BAB COCK
 GRASPING FORCEPS
 TUNGSTEN CARBIDE

6"
 8"



TOWEL CLIP
 CROSS ACTION

FORCEPS



**HYSTERECTOMY
 MAINGOTS FORCEPS**
 STRAIGHT 8"



**HYSTERECTOMY
 MAINGOTS FORCEPS**
 CURVED 8"



**HYSTERECTOMY
 GWILLIAM FORCEPS**
 STRAIGHT 8"

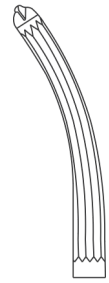

**HYSTERECTOMY
 GWILLIAM FORCEPS**
 CURVED 8"



HYSTERECTOMY CLAMP
 DeBAKEY CLAMP

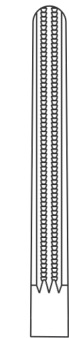

STRAIGHT

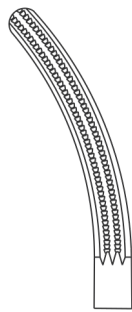

CURVED

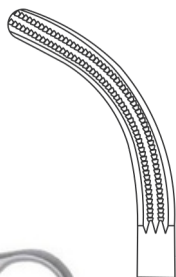

HALF CURVED

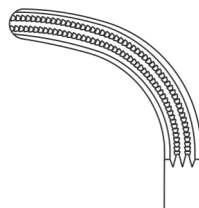

FULL CURVED



**KOVAC HYSTERECTOMY
 TOOTH CLAMP**



STARIGHT



CURVED

FORCEPS



HEANYS HYSTERECTOMY
 FORCEPS SINGLE TOOTH
 CURVED



HEANYS HYSTERECTOMY
 FORCEPS DOUBLE TEETH
 CURVED



LAHEY'S
 FORCEPS



MIXTURE LIGATURE
 RIGHT ANGLED FORCEPS



6"
 8"
 10"



GREEN
 ARMYTAGE FORCEPS



FORCEPS



STRAIGHT
8"
10"
SPONGE
HOLDING FORCEPS



curved
12"
KELLY
POLYPUS FORCEPS



STRAIGHT

OVEM FORCEPS



CURVED



UTERINE VULSELLUM
FORCEPS

FORCEPS



**UTERINE DRESSING
FORCEPS**



**UTERINE TENACULUM
SINGLE TOOTH FORCEPS**



**UTERINE TENACULUM
DOUBLE TEETH FORCEPS**



**UTERINE TENACULUM
SINGLE TOOTH FORCEPS,**

FORCEPS



CHEATLE
JAR



CHEATLE FORCEPS

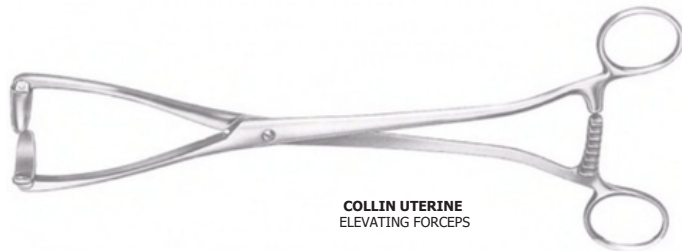

COLLIN UTERINE
ELEVATING FORCEPS

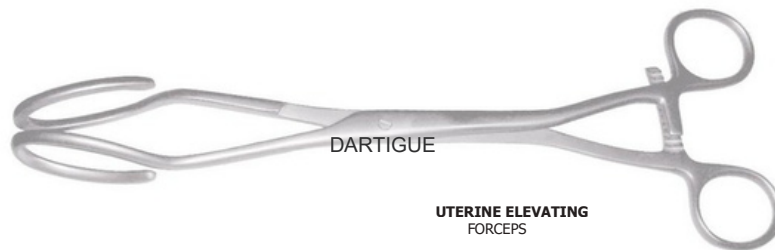

DARTIGUE

UTERINE ELEVATING
FORCEPS

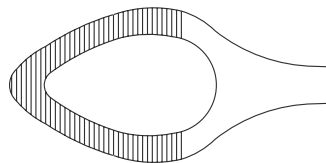

58.460.20 SOMER FORCEPS (25.5 cm) SCREW JOINT

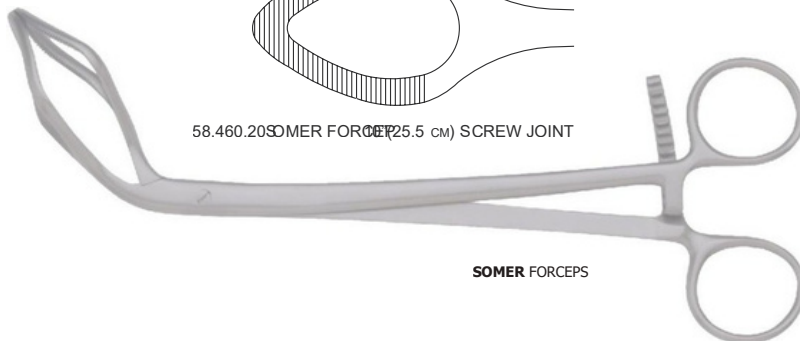

SOMER FORCEPS

FORCEPS



UTERINE MANIPULATOR
RING HANDLE
DOUBLE ACTION



UTERINE MANIPULATOR
RING HANDLE

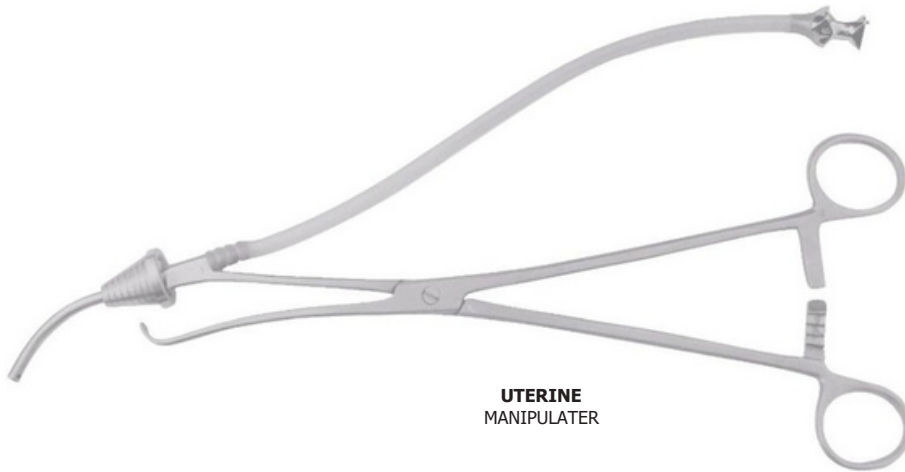

UTERINE
MANIPULATOR



Not to scale



WILLETT PLACENTA
FORCEPS

FORCEPS



KOGAN 9.5" (24cm) CALIBRATE

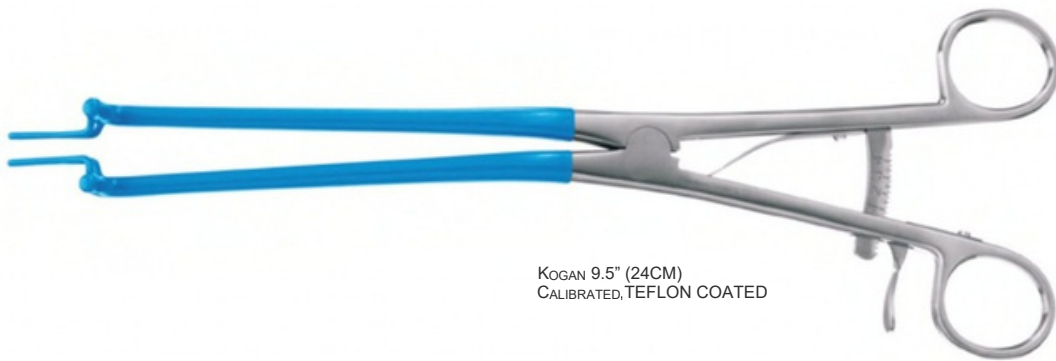

KOGAN 9.5" (24CM)
CALIBRATED, TEFLON COATED

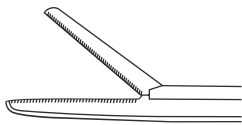
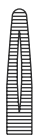

IUCD REMOVAL FORCEPS



IUCD UTERINE HOOK

RETRACTORS



COTTLE
RETRACTOR
BLUNT

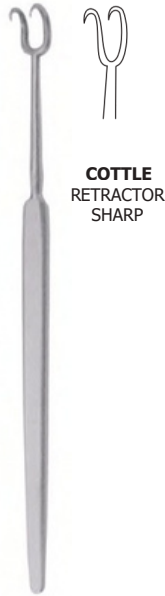

COTTLE
RETRACTOR
SHARP

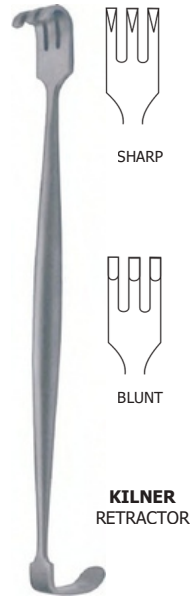

KILNER
RETRACTOR

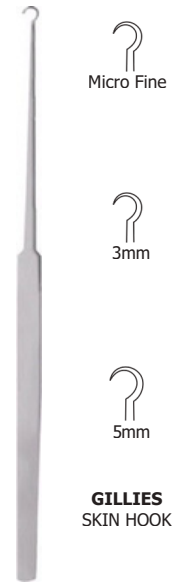

GILLIES
SKIN HOOK



MIDWIFERY FORCEPS
SIMPSON



WRIGGLE
FORCEPS

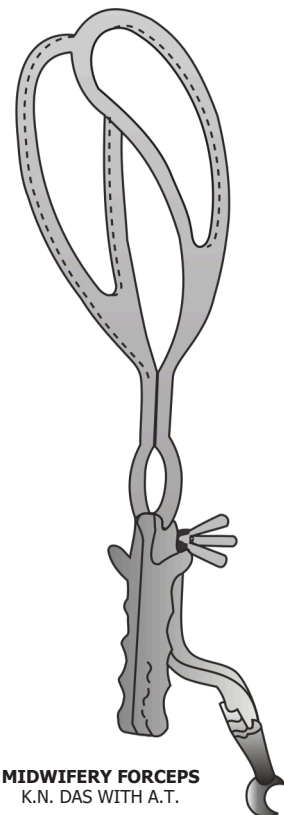

MIDWIFERY FORCEPS
K.N. DAS WITH A.T.

BIOPSY PUNCH

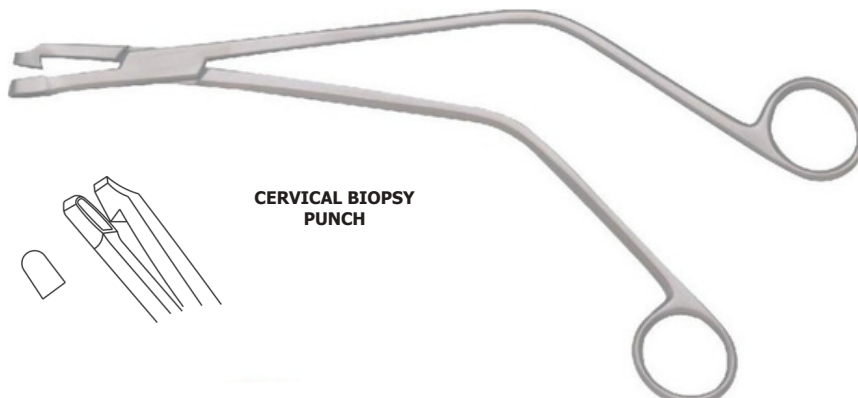
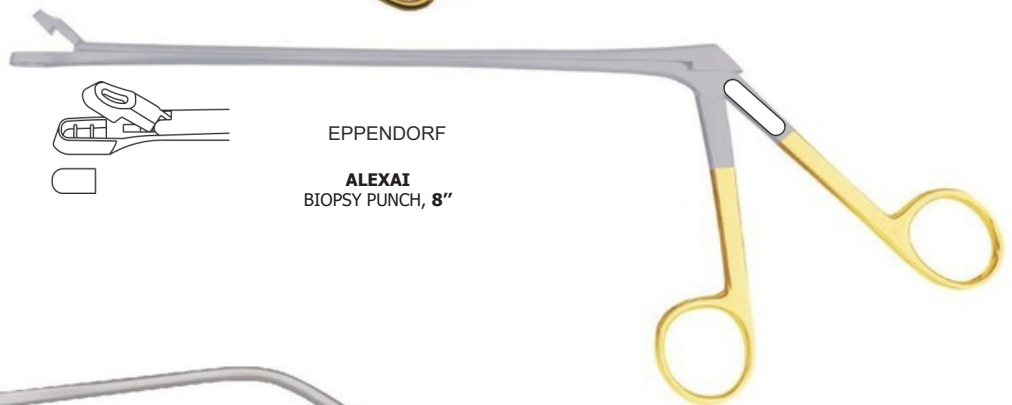

RETRACTORS



LANGENBECK
 RETRACTOR
 SMALL
 25MM x 6MM
 35MM x 15MM



LANGENBECK
 RETRACTOR
 LARGE
 45MM x 20MM
 65MM x 25MM
 75MM x 25MM
 90MM x 25MM

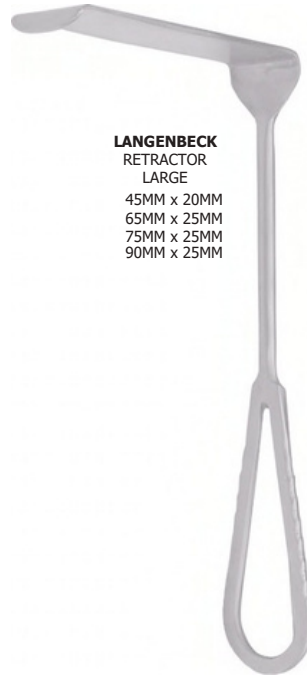

LANGENBECK RETRACTOR
 WITH FIBER OPTIC LIGHT CARRIERS
 45MM x 20MM
 75MM x 25MM



CZERNY RETRACTOR
 6"
 8"



LANE'S RETRACTOR
 SET OF 2



ROUX RETRACTOR
 SET OF 3



SELF RETAINING
 RETRACTOR- 6"

- 2x2
- 2x3
- 3x3
- 3x4



CONE SELF
 RETAINING ADJUSTABLE
 RETRACTOR 4 x3

- 6" Blunt
- 8" Sharp
- 8" Blunt

RETRACTORS



LONDON VAGINAL RETRACTOR
RIGHT ANGLED



LONDON VAGINAL RETRACTOR
RIGHT ANGLED, TEFLON COATED



WERYHEIM RETRACTOR
(3X9.5X27.5 CM)



DOYEN RETRACTOR

- 1"
- 1 1/2"
- 2"
- 2 1/2"
- 3"
- 3 1/2"
- 4"



DOYEN RETRACTOR
WITH FIBER OPTIC
LIGHT CARRIERS
2 1/2"



KELLY RETRACTOR
LOOP HANDLE

- 2"X1 1/2"
- 2 1/2"X2"
- 3"X2 1/2"
- 3 1/2"X2 1/4"

RETRACTORS



PLAIN

15CM X 30MM
12CM X 25MM



WITH TEETH

15CM X 30MM
12CM X 25MM

TEBBETTS RETRACTOR
WITH FIBER OPTIC ILLUMINATION
& SUCTION TUBE

RETRACTORS & HOOKS



SKIN HOOK, 10"-25.5 CM



HOOK, 10"-25.5 CM



HOOK WITH 3 PRONGS, 10"-25.5 CM

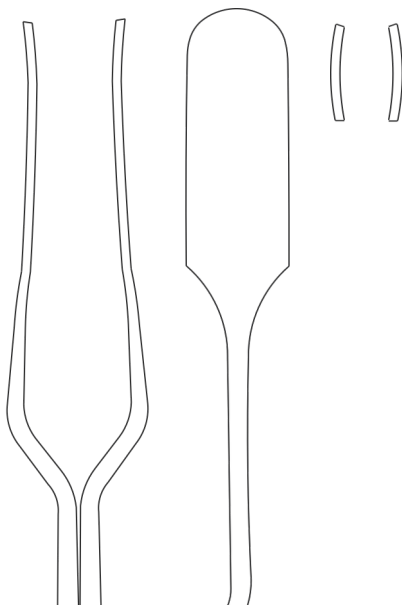

VAGINAL WALL RETRACTOR(UP TO 3"), -25.5, 7.5CM



VAGINAL WALL RETRACTOR(UP TO 3"), -25.5, 7.5CM, TEFLON COATED

SPECULUMS

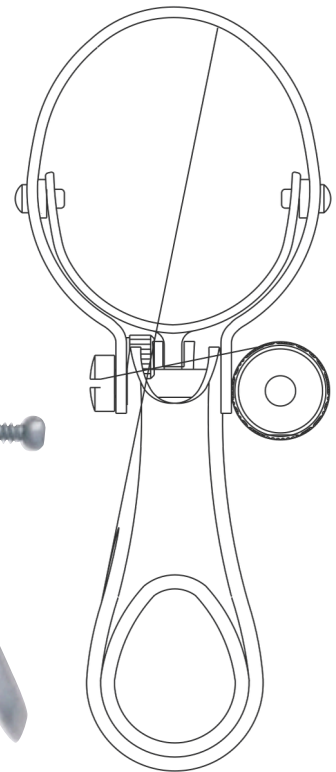
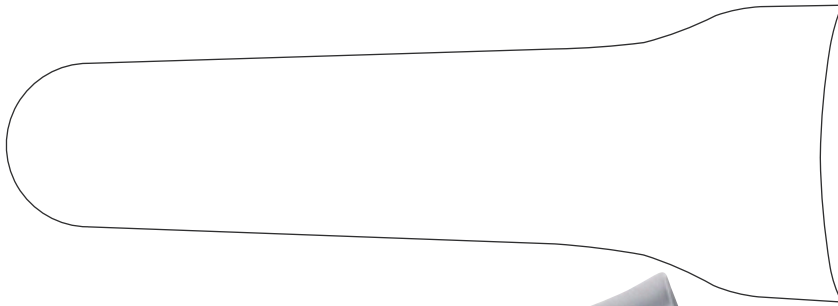

CUSCO SPECULUM

- SMALL 22X80MM
- MEDIUM 25X100MM
- LARGE 27X105MM

CUSCO SPECULUM WITH FIBER OPTIC LIGHT

- SMALL 22X80MM
- MEDIUM 25X100MM
- LARGE 27X105MM

PECULUMS



CUSCO SPECULUM BLACK COATED

- SMALL 22X80MM
- MEDIUM 25X100MM
- LARGE 27X105MM

SPECULUMS

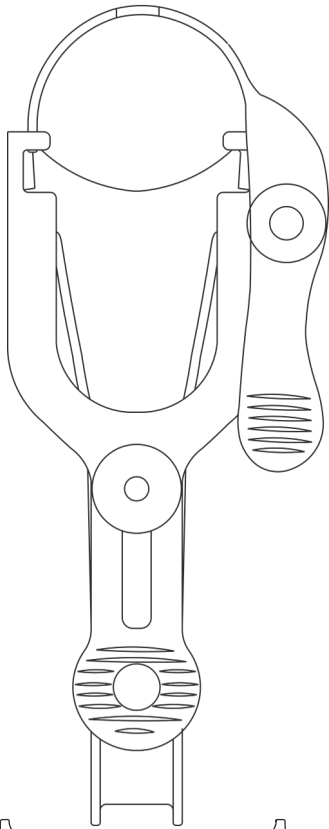

GRAVES SPECULUM

SMALL 20X75MM

MEDIUM 35X95MM

LARGE 35X115MM

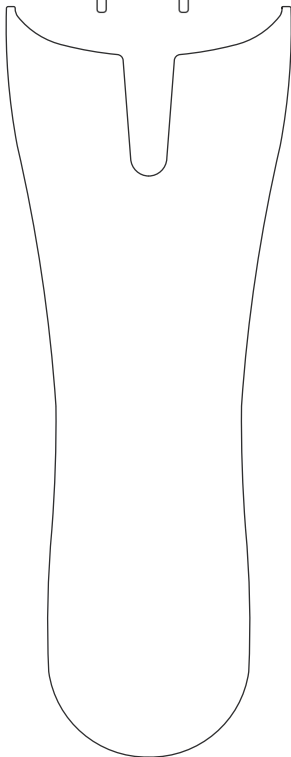

PEDRSON SPECULUM

SMALL 17X100MM

MEDIUM 13X75MM

LARGE 22X100MM

EXTRA LARGE 25X120MM

SPECULUMS

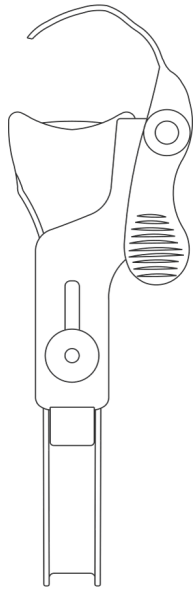

WEISMAN GRAVES **LEFT OPEN 35X115MM**

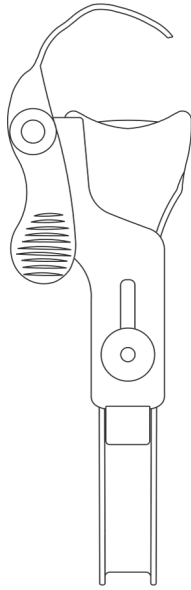

WEISMAN GRAVES **RIGHT OPEN 35X115MM**

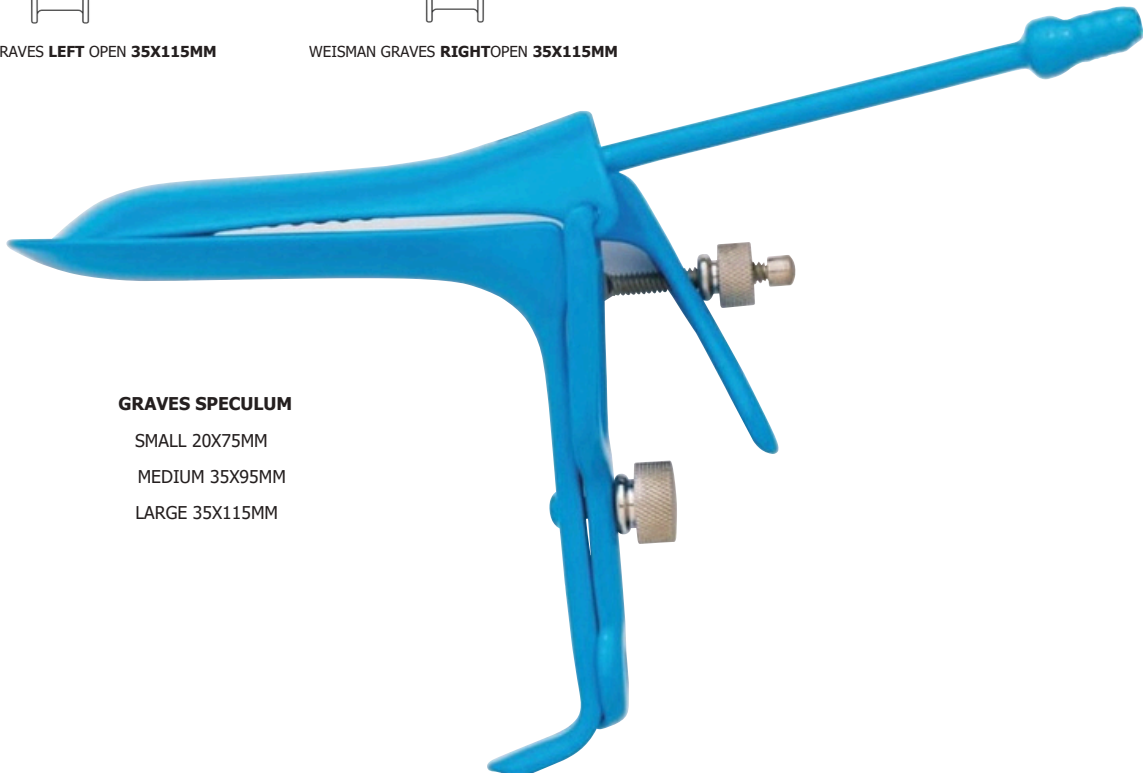

GRAVES SPECULUM

SMALL 20X75MM

MEDIUM 35X95MM

LARGE 35X115MM

SPECULUMS



UWARD

UWARD SPECULUM



KRISTELLER VAGINAL
SPECULUM
SMALL
MEDIUM
LARGE

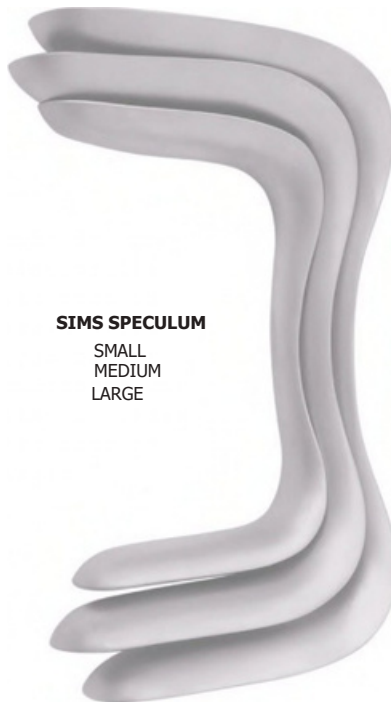

SIMS SPECULUM
SMALL
MEDIUM
LARGE



SIMS SPECULUM
WITH FIBER OPTIC
LIGHT CARRIER

GYNAE INSTRUMENTS



ENDOMETRIAL BIOPSY CURETTE NOVAK 7313

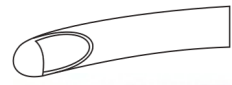

RANDALLS ENDOMETRIAL BIOPSY CURETTE



GRADUATED UTERINE SOUND

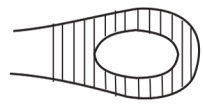
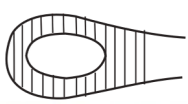

INTERIOR VAGINAL WALL RETRACTOR

CURETTES



RECAMIER RIGID SHARP

- 5MM
- 6MM
- 7MM
- 8MM
- 9MM
- 11MM
- 12MM
- 14MM
- 15MM
- 16MM
- 19MM
- 20MM
- 21MM
- 23MM
- 25MM

RECAMIER RIGID

- 5MM
- 6MM
- 7MM
- 8MM
- 9MM
- 11MM
- 12MM
- 14MM
- 15MM
- 16MM
- 19MM
- 20MM
- 21MM
- 23MM
- 25MM

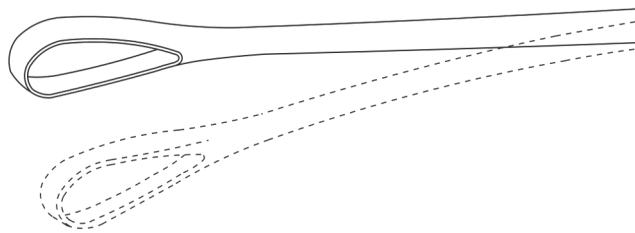

RECAMIER MALLEABLE SHARP 12.5"-32CM

- 5MM
- 6MM
- 7MM
- 8MM
- 9MM
- 11MM
- 12MM
- 14MM
- 15MM
- 16MM
- 19MM
- 20MM
- 21MM
- 23MM
- 25MM

RECAMIER MALLEABLE BLUNT 12.5"-32CM

- 5MM
- 6MM
- 7MM
- 8MM
- 9MM
- 11MM
- 12MM
- 14MM
- 15MM
- 16MM
- 19MM
- 20MM
- 21MM
- 23MM
- 25MM

CURETTES



SIMS UTERINE CURETTE , **SEMI SHARP** 10"-25.5CM

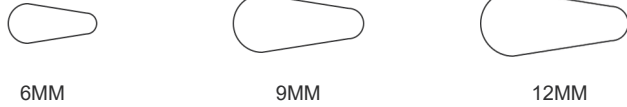

6MM

9MM

12MM

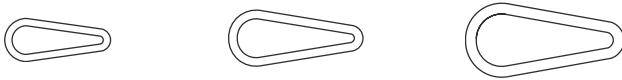

6MM

9MM

12MM

SIMS UTERINE CURETTE , **BLUNT** 10"-25.5CM

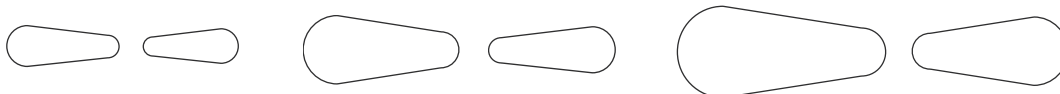

6X5MM

9X6MM

12X9MM

SIMS UTERINE CURETTE , **SEMI SHARP** 10"-25.5CM
DOUBLE ENDED



6X5MM

9X6MM

12X9MM

SIMS UTERINE CURETTE , **SEMI SHARP & BLUNT** 10"-25.5CM
DOUBLE ENDED

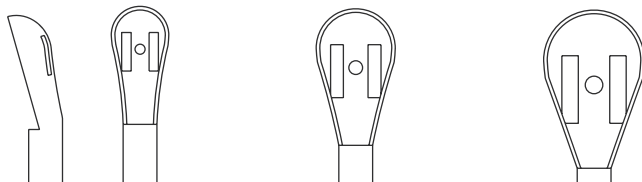

8MM

11MM

14MM

SIMS UTERINE CURETTE , **SEMI SHARP** 10"-25.5CM
WITH SUCTION

DILATORS

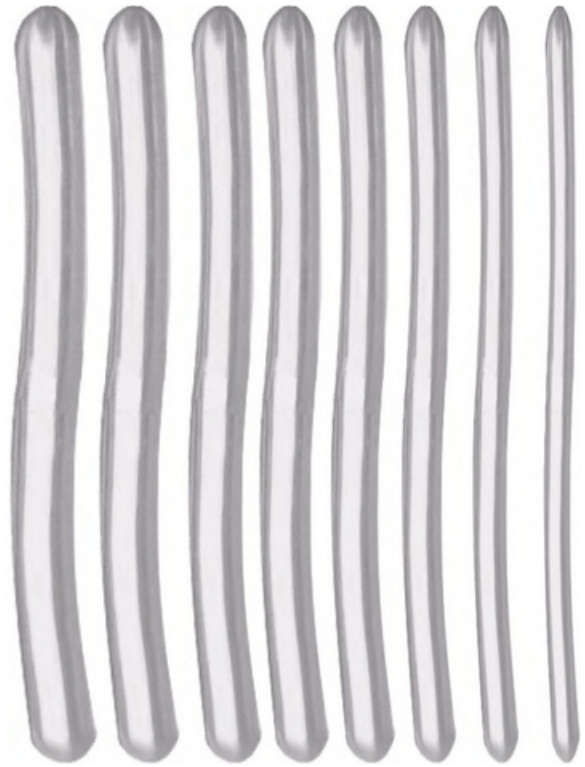

HEGAR DILATORS
SET OF 8

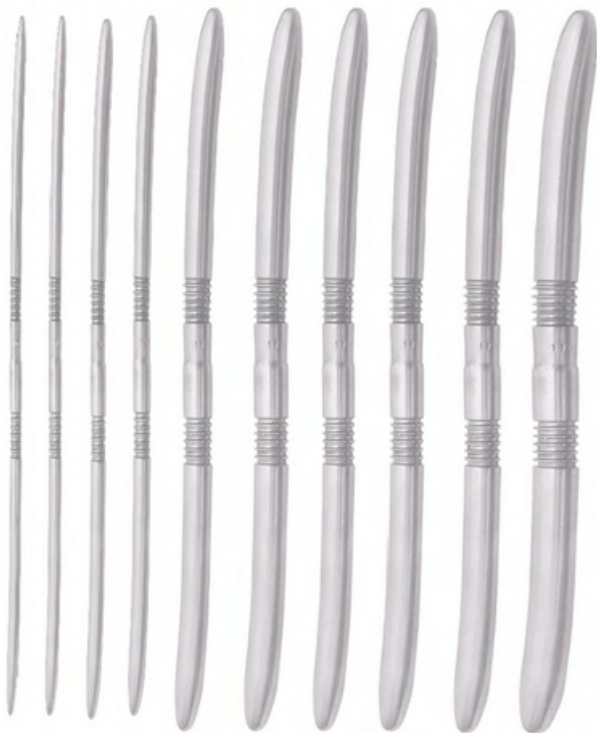

HEGAR DILATORS
GRADUATED FINE 1/2MM
SET OF 10



HEGAR DILATORS
SINGLE ENDED
SET OF 16

GYNAE INSTRUMENTS



MARTIN
PELVIMETERS



FOETAL
STETHOSCOPE



PERFORATOR
SIMS FORCEPS



POOL SUCTION
CANNULA



MYMO-SCREW

SUCTION & CANNULAS



**FEMALE
CATHETER**



**YANKAUER TONSIL
SUCTION TUBE**



**M.T.P. CANNULA METAL
SET OF 6**



SIZE
2.5 MM
3.5 MM
4.5 MM

**MONOPOLAR
SUCTION TUBE**



SIZE
2.0mm
2.7 mm
3.3mm
4.0mm
4.7mm

**LEMPERTMASTOID
SUCTION
TUBES**

MICRO INSTRUMENTS



WITHOUT CATCH

	SIZE
S.S	6"
TITANIUM	6"
S.S	7"
TITANIUM	7"

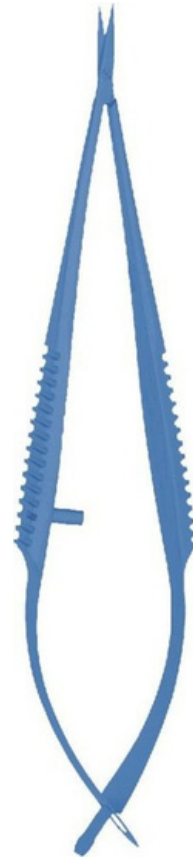

	SIZE
S.S	6"
TITANIUM	6"
S.S	7"
TITANIUM	7"

	SIZE
S.S	6"
T.C	6"
TITANIUM	6"
S.S	7"
T.C	7"
TITANIUM	7"

MICRO SPRING NEEDLE HOLDER FLAT HANDLE

MICRO SPRING SCISSORS FLAT HANDLE

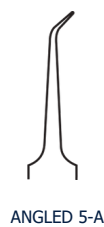

MICRO JEWELLERS FORCEPS

TITANIUM

TITANIUM

TITANIUM

TITANIUM

TITANIUM

TITANIUM

BLADES & HANDLES



LONG HANDLE
 B.P. Handle 3



LONG HANDLE
 B.P. Handle 4



B.P. Handle 7



ROUND. Handle 3

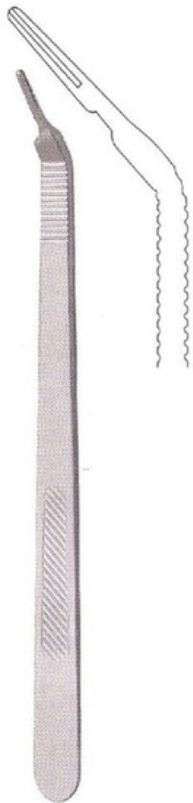

B.P. Handle Curved



VERTICAL CUTTING NO-3
 HORIZONTAL CUTTING NO-3
 VERTICAL CUTTING NO-4



ROUND HANDLE
 NO-3
 NO-4



No.10



No.11



No.12



No.15



No.21



No.23

BIPOLAR INSTRUMENTS



16 cm
19.5 cm
B-15141 25 cm
BIPOLAR COAGULATION
FORCEPS BAYONET TIP-1MM



16 cm
19.5 cm
BIPOLAR COAGULATION
FORCEPS BAYONET TIP-1MM



16 cm
19.5 cm
BIPOLAR COAGULATION
FORCEPS BAYONET TIP-1MM
WITH SUCTION



16 cm
19.5 cm
BIPOLAR COAGULATION
FORCEPS (ST.) TIP-1MM



16 cm
19.5 cm
BIPOLAR COAGULATION
FORCEPS (ST.) TIP-1MM



16 cm
19.5 cm
BIPOLAR COAGULATION
FORCEPS CURVED TIP-1MM



16 cm
19.5 cm
BIPOLAR COAGULATION
FORCEPS CURVED WITH TWO PINS TIP-1MM



16 cm
19.5 cm
BIPOLAR COAGULATION
FORCEPS CURVED TIP-1MM



16 cm
19.5 cm
BIPOLAR COAGULATION
FORCEPS CURVED TIP-1MM
WITH SUCTION



16 cm
19.5 cm
BIPOLAR COAGULATION
FORCEPS CURVED TIP-1MM
WITH TWO PINS

BIPOLAR INSTRUMENTS



19.5 cm
25cm
BIPOLAR COAGULATION
FORCEPS BAYONET TIP-1MM



19.5 cm
BIPOLAR COAGULATION
FORCEPS BAYONET TIP-1MM



19.5 cm
BIPOLAR COAGULATION
FORCEPS BAYONET TYPE TIP-1MM
WITH SUCTION



16 cm
19.5 cm
BIPOLAR COAGULATION
FORCEPS (ST.) TIP-1MM



16 cm
19.5 cm
BIPOLAR COAGULATION
FORCEPS (ST.) TIP-1MM



16 cm
19.5 cm
BIPOLAR COAGULATION
FORCEPS CURVED TIP-1M M



16 cm
19.5 cm
BIPOLAR COAGULATION
FORCEPS CURVED TIP-1MM
WITH TWO PINS



16 cm
19.5 cm
BIPOLAR COAGULATION
FO R C EPS CURVED TIP-1MM



16 cm
19.5 cm
BIPOLAR COAGULATION
FORC E P S CURVED TIP-1MM
WITH SUCTION



16 cm
19.5 cm
BIPOLAR COAGULATION
FORCE P S CURVED TIP-1MM
WITH TWO PINS

BIPOLAR INSTRUMENTS



BALL PROBE

WORKING LENGTH- 140MM

3MM
5MM



LOOPS

WORKING LENGTH- 140MM

1.5X1.5MM
2.0X1.5MM
2.0X1.5MM
2.0X2.0MM



NEEDLE

WORKING LENGTH- 35MM



**PENCIL
CABLE**



MONOPOLAR CABLE



CABLE



BIPOLAR CABLE FLAT PIN



BIPOLAR CABLE TWO PIN



**ARTERY FORCEPS
STRAIGHT**

7"



**ARTERY FORCEPS
CURVED**

7"



**TURNER WARWICK SCISSORS
STRAIGHT**

7"



**TURNER WARWICK
SCISSORS
CURVED**

7"

HOLLOWWARE



BOWL
STAINLESS STEEL

3"
4"
5"
6"
8"



SILICONE VENTOUSE CUP
(VACCUUM CUPS)

small
medium
large



BASINS
STAINLESS STEEL

10"
12"
14"



DRESSING DRUMS
HEAVY DUTY STAINLESS STEEL

6" x 6"
9" x 5"
9" x 9"
9" x 11"
11" x 5"
12" x 10"
14" x 9"
14" x 12"
15" x 12"



PORTABLE SINGLE DRUM
AUTOCLAVE HEAVY DUTY
STAINLESS STEEL

[http://medgyn.com/12" X 12"](http://medgyn.com/12\)

TRAYS

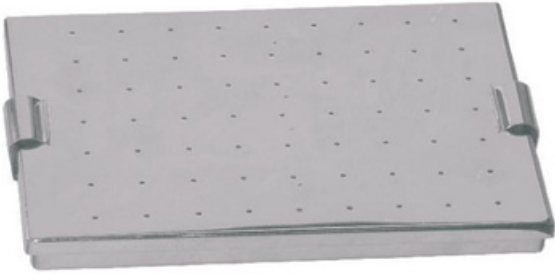

**INSTRUMENTS STERILIZING
 PERFORATOR BOX**
 STAINLESS STEEL
 8" x 4" x 2"
 11" x 7" x 2"
 12" x 10" x 3"
 14" x 10" x 2"



AUTOClave INSTRUMENT BOX
 WITH SILICONE MATT
 STAINLESS STEEL
 8" x 4" x 1"
 9" x 8" x 1"
 14" x 8" x 1"



CIDEX BOX HEAVY
 STAINLESS STEEL
7468 2 8" x 6" x 5"



SURGICAL TRAY WITH LID
 HEAVY STAINLESS STEEL
 6" x 9"
 7" x 11"
 8" x 10"
 10" x 12"
 12" x 15"



**KIDNEY TRAY
 HEAVY**
 STAINLESS STEEL
 6"
 8"
 10"
 12"

SUCTION & LIGHT SOURCE



SUCTION MACHINE
HI - VAC 4.5 LTRS
(50x38x70)CMS



SUCTION MACHINE
JUNIOR HI - VAC 3.0 LTRS
(39x33x65)CMS



SUCTION MACHINE
EP-90 ELECTRIC CUM MANUAL

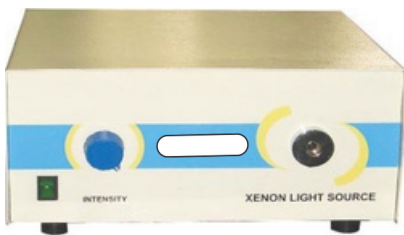

ULTRA COMPACT
XENON LIGHT SOURCE 300W



FIBER OPTIC CABLE
3.5 mm length 230 cm
4.5 mm length 230 cm



LED LIGHT SOURCE



FIBER OPTIC COLD LIGHT SOURCE
DOUBLE POINT 24 V - 250 W



FIBER OPTIC COLD LIGHT SOURCE
SINGLEPOINT15V - 150W



HEALTHCORE

VENTURES

build.scale.expand.

Unit no 157, Kaliandas Udyog Bhavan, near Century Bazar, Prabhadevi, Mumbai- 400025

Tel: +91 86554 11521

Email: sales@healthcoreventures.com

Web: www.healthcoreventures.com