



PRODUCT CATALOGUE

Neurosurgery Instruments

NEUROSURGERY INSTRUMENTS

INDEX

- KERRISONS & DISC RONGEURS
- BONE NIBBLER
- RETRACTOR
- SELF RETAINING RETRACTOR
- GENERAL RETRACTOR
- OSTEOTOME ,CHISEL ,HAMMER
- ELEVATOR
- CURETTE
- MICRO & GENERAL SCISSORS
- MICRO VASCULAR & GENERAL DISSECTING FORCEPS
- MICRO & GENERAL NEEDLE HOLDER
- MICRO NEURO FORCEPS
- FINE ELEVATOR HOOKS KNIFE PROBE
- RHOTON SET
- PITUITARY INSTRUMENTS
- SUCTION & CANNULAS
- HUDSON, DRILLS & SKULL INSTRUMENTS
- TRANSORAL INSTRUMENTS
- BLADES & HANDLES
- BONE CUTTER
- BIPOLAR INSTRUMENTS
- GENERAL FORCEPS
- LIGHTS , HOLLOWARE & TRAYS ETC



HYGIENIC LUMBAR AND CERVICAL KERRISON LAMINECTOMY RONGEURS

**SHAFT
LENGTH** **BITE
Size**

7'' 1mm
2mm
3mm
4mm
5mm

8'' 1mm
2mm
3mm
4mm
5mm

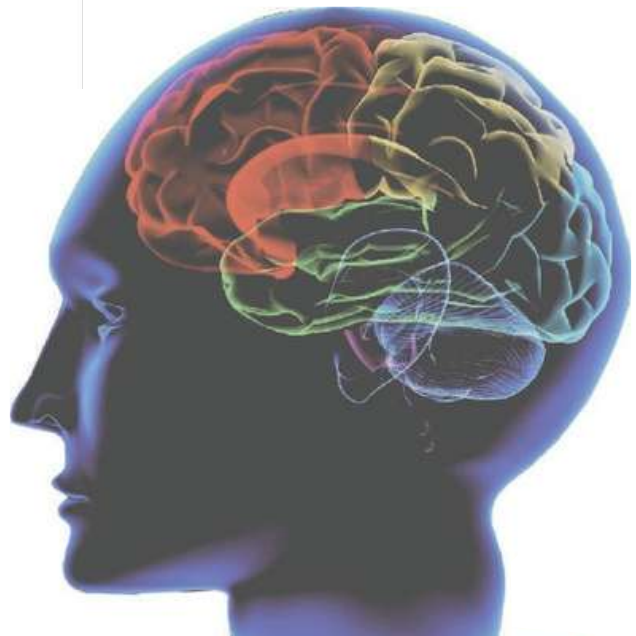

90 UP 90 DOWN 40UP 40 DOWN

RONGEURS

HYGIENIC LUMBAR AND CERVICAL KERRISON LAMINECTOMY RONGEURS



| | | |
|----|-----|--------|
| 7" | 1mm | N-9531 |
| | 2mm | N-9532 |
| | 3mm | N-9533 |
| | 4mm | N-9534 |
| | 5mm | N-9535 |

| | | |
|----|-----|--------|
| 8" | 1mm | N-9561 |
| | 2mm | N-9562 |
| | 3mm | N-9563 |
| | 4mm | N-9564 |
| | 5mm | N-9565 |

| | | |
|----|-----|--------|
| 9" | 1mm | N-9593 |
| | 2mm | N-9594 |
| | 3mm | N-9595 |
| | 4mm | N-9596 |
| | 5mm | ----- |

RONGEURS



**HYGIENIC LUMBAR AND CERVICAL
KERRISON LAMINECTOMY
RONGEURS SEMI-DETACHABLE SHAFT**

7"
1mm
2mm
3mm
4mm

8"
1mm
2mm
3mm
4mm

RONGEURS



KERRISON FORAMINOTOMY RONGEURS, CURVED

| SHAFT LENGTH | BITE SIZE | 90° UP |
|-------------------------|----------------------|---------------|
| 7" | 1mm | EX- 3083 |
| | 2mm | EX- 3124 |
| | 3mm | EX- 3125 |
| 8" | 3mm | N-9640 |
| | 4mm | N-9641 |

RONGEURS

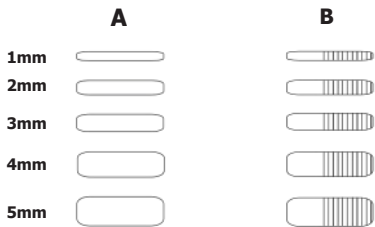
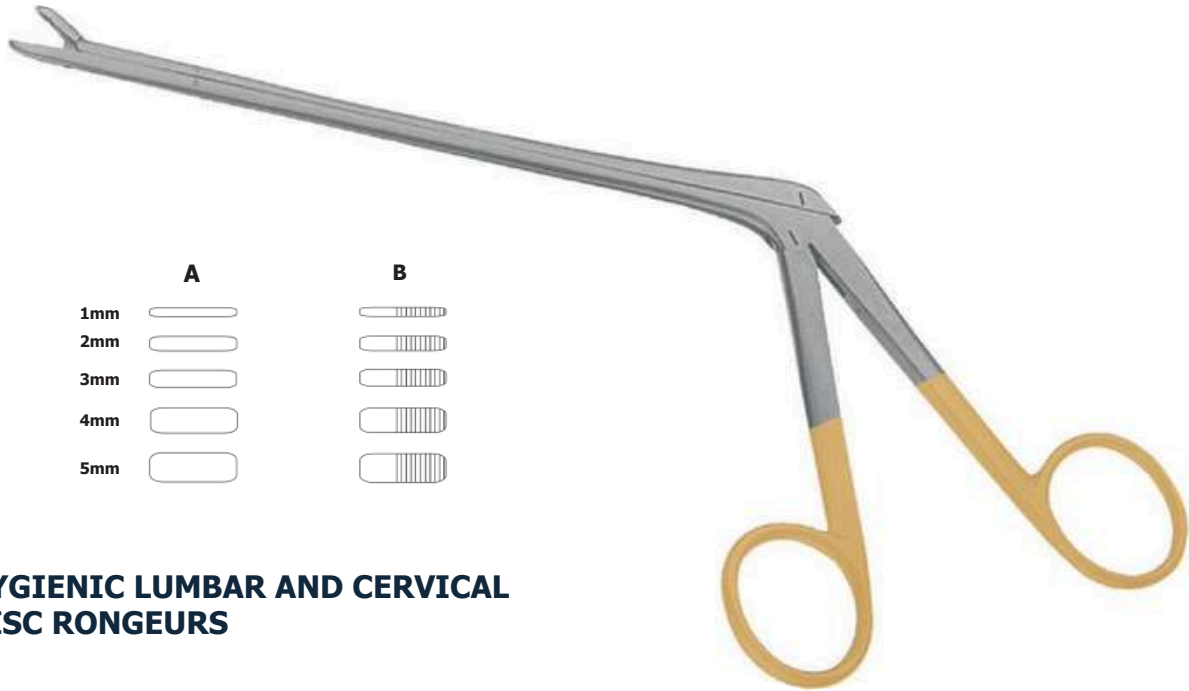

HYGIENIC LUMBAR AND CERVICAL DISC RONGEURS

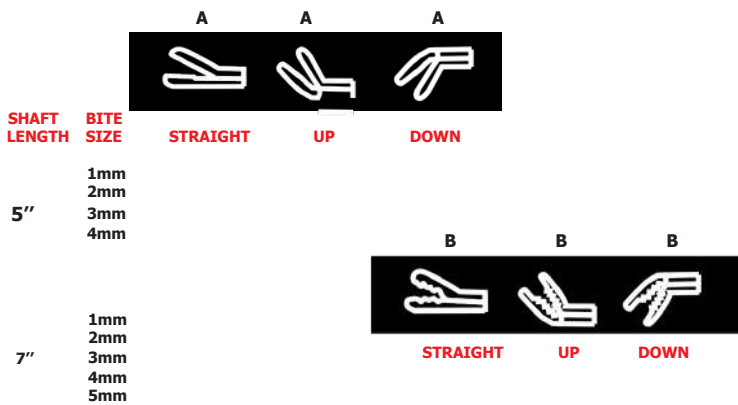

MICRO DISC RONGEUR FINE SHAFT

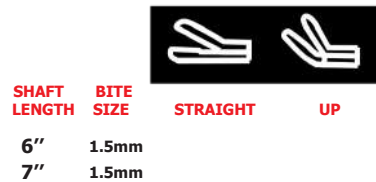

RONGEURS

FERRIS-SMITH RONGEURS 7"



SHAFT LENGTH

BITE SIZE

STRAIGHT

UP

DOWN

7"

2mm
3mm
4mm
5mm

SPINAL IVD RONGEURS BAYONET SHAPED (UP, RIGHT & LEFT) WORKING LENGTH 7"

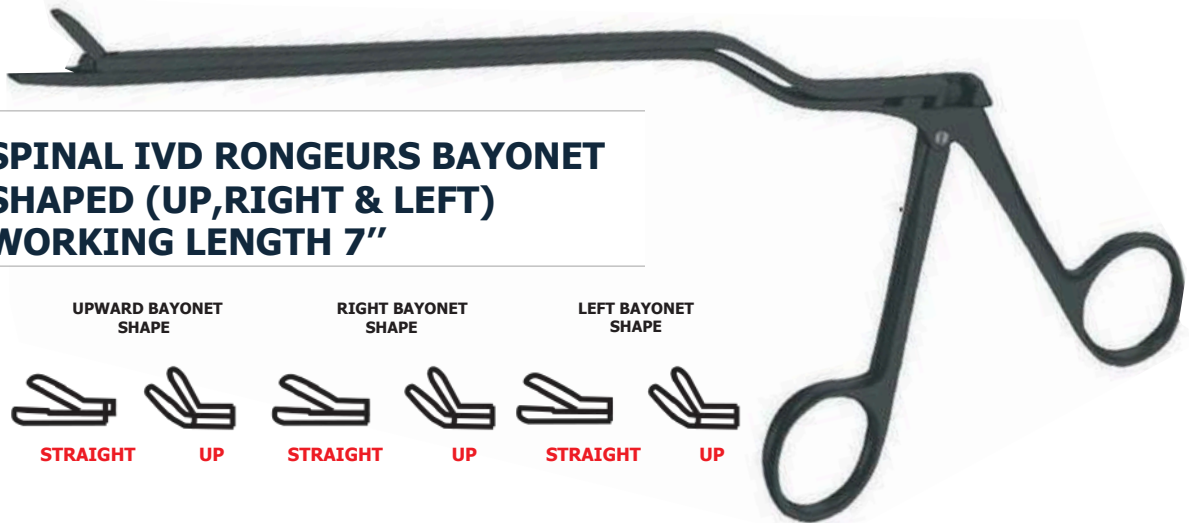

UPWARD BAYONET SHAPE

RIGHT BAYONET SHAPE

LEFT BAYONET SHAPE

BITE Size



STRAIGHT

UP

STRAIGHT

UP

STRAIGHT

UP

2mm
3mm
4mm

FORCEPS

EX-3060 EX-3061 EX-3062



STRAIGHT **RIGHT** **LEFT**



SCISSORS
LENGTH- 13cm

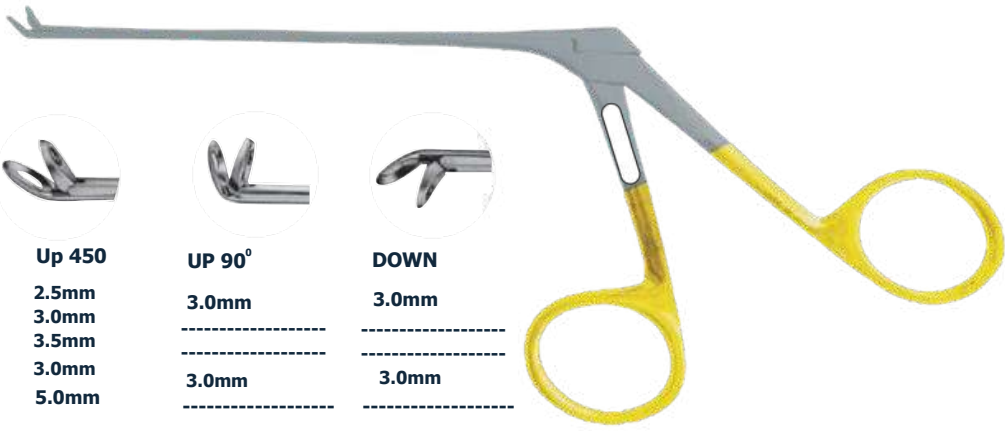

STRAIGHT **Up 45°** **UP 90°** **DOWN**

| | | | |
|--------------|--------------|--------------|--------------|
| 13 CM | 2.5mm | 3.0mm | 3.0mm |
| 13 CM | 3.0mm | ----- | ----- |
| 13 CM | 3.5mm | ----- | ----- |
| 18 CM | 3.0mm | 3.0mm | 3.0mm |
| 18 CM | 5.0mm | ----- | ----- |

18 CM 3.0mm,LEFT
18 CM 3.0mmRIGHT

BLAKESLEY FORCEPS
LENGTH- 13cm & 18cm



STRAIGHT **UP 45°**













EX-3106 **EX-3107**

BLAKESLEY FORCEPS
WITH SUCTION
LENGTH- 17.5cm

FORCEPS



MICRO FORCEPS (19cm)

| | STRAIGHT | RIGHT | LEFT | UP |
|----------------|---|---|--|---|
| GRASPER |  LENGTH 19cm |  LENGTH 19cm |  LENGTH 19cm |  LENGTH 19cm |
| CUP |  LENGTH 19cm |  LENGTH 19cm |  LENGTH 19cm |  LENGTH 19cm |
| SCISSOR |  LENGTH 19cm |  LENGTH 19cm |  LENGTH 19cm |  LENGTH 19cm |

RONGEURS



BOEHLER



BEYER



LUER STILLE

BONE BITING RONGEURS

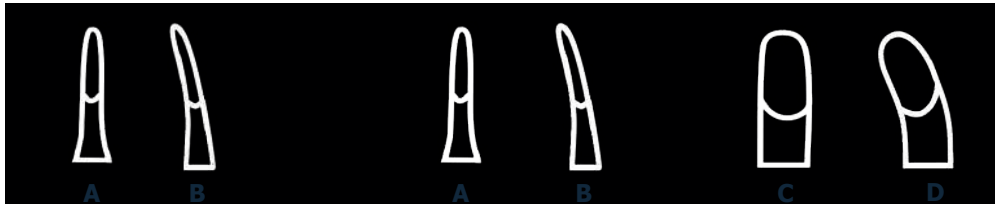

STRAIGHT CURVED

- | | |
|----------|----------|
| A | B |
| 15cm | 2mm |
| 15cm | 3mm |
| 15cm | 4mm |

STRAIGHT CURVED

- | | |
|----------|----------|
| A | B |
| 19cm | 2mm |

STRAIGHT CURVED

- | | |
|----------|----------|
| A | B |
| 2 6cm | 15mm |
| 2 6cm | 10mm |
| 26cm | 8mm |

RUSKIN



MAYFIELD



ROTTGEN RUSKIN



BONE BITING RONGEURS

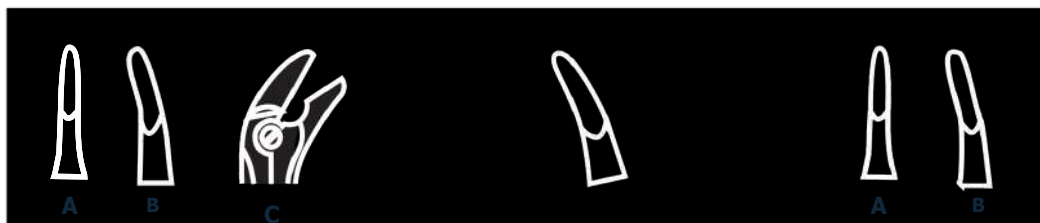

RUSKIN
STRAIGHT CURVED

| A | B |
|------|----|
| 19cm | 2m |
| | m |
| 19cm | 3m |
| 19c | m |
| m | 4m |
| 19c | m |
| m | 5m |
| 19c | m |
| m | 6m |

MAYFIELD
STRAIGHT CURVED

| | |
|------|----|
| 18cm | 3m |
| 18cm | m |
| 18cm | 4m |
| | m |
| | 5m |
| | m |

ROTTGEN-RUSKIN
STRAIGHT CURVED

| B | A |
|------|----|
| 24cm | 4m |
| 24cm | m |
| 24cm | 5m |
| | m |
| | 6m |
| | m |

RONGEURS

STILLE-RUSKIN



SMITH-PETERSON



LEKSELL



BONE BITING RONGEURS

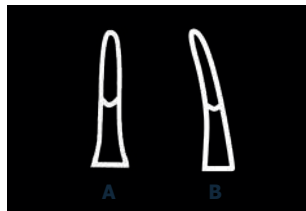
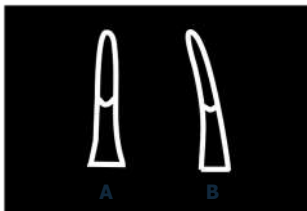

STILLE-RUSKIN

STRAIGHT CURVED

| A | B |
|------|------|
| 23cm | 5mm |
| 23cm | 6mm |
| 23cm | 8mm |
| 23cm | 10mm |

SMITH-PETERSON

STRAIGHT CURVED

| A | B |
|------|-----|
| 23cm | 3mm |
| 23cm | 4mm |

STRAIGHT CURVED

| A | B |
|------|-----|
| 23cm | 3mm |
| 23cm | 5mm |
| 23cm | 8mm |

RONGEURS



BONE BITING RONGEURS

ECHLIN

- 23cm 2mm
- 23cm 3mm
- 23cm 4mm
- 23cm 6mm

CRANIAL RONGEURS

19cm

8mm

LUER-FRIEDMANN

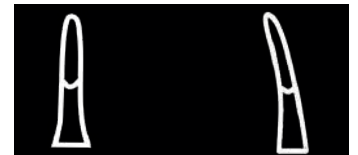

A
STRAIGHT
19cm

B
CURVED
4mm
6mm

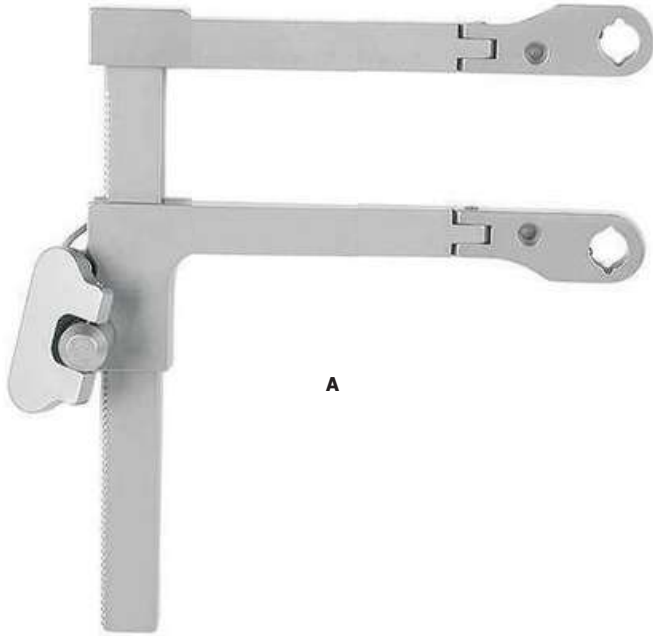

A



CASPAR TRANSVERSE BASIC CERVICAL RETRACTOR

CERVICAL RETRACTOR SINGLE HINGED

CERVICAL RETRACTOR SINGLE HINGED
(BLACK COATED)
CERVICAL RETRACTOR DOUBLE HINGED
(BLACK COATED)

MEDIAL TOOTHED BLADES

STAINLESS STEEL
23 mm , WIDTH (BLACK COATED)

LENGTH

40mm
45mm
50mm
55mm
60mm
65mm

LATERAL SERRATED BLADES

STAINLESS STEEL
23mm , WIDTH (BLACK COATED)

LENGTH

40mm
45mm
50mm
55mm
60mm
65mm

COUNTER TRANSVERSE BASIC RETRACTOR FOR LONGITUDINAL RETRACTION



CERVICAL RETRACTOR DOUBLE HINGED (BLACK COATED) 8"



CERVICAL RETRACTOR SINGLE HINGED 6 1/2"

CERVICAL RETRACTOR SINGLE HINGED (BLACK COATED) 6 1/2"



LONGITUDINAL CERVICAL RETRACTOR SINGLE HINGED (BLACK COATED)



CASPER FORCEPS FOR CHANGING THE BLADES



D

LATERAL BLUNT BLADES STAINLESS STEEL 23 mm, WIDTH (BLACK COATED)

LENGTH

- 40mm
- 45mm
- 50mm
- 55mm
- 60mm
- 65mm



F

LONGITUDINAL BLADES STAINLESS STEEL 19 mm, WIDTH (BLACK COATED)

LENGTH

- 40mm
- 45mm
- 50mm
- 55mm
- 60mm
- 65mm



RETRACTOR

CLOWARD CERVICAL SPINE SELF-RETAINING RETRACTORS WITH BALL SNAP CLOSURE



SINGLE HINGE SMALL
18CM/7"



SINGLE HINGE LARGE
25.5cm/10"



DOUBLE HINGE LARGE
25.5cm/10"



G
EXCHANGEABLE BLADES
SERRATED



F
EXCHANGEABLE BLADES
BLUNT

CLOWARD CERVICAL SPINE RETRACTOR EXCHANGEABLE BLADES 15/23WIDTH

SERRATED BLADES

LENGTH

35mm
40mm
45mm
50mm
55mm
60mm
65mm

BLUNT BLADES

LENGTH

35mm
40mm
45mm
50mm
55mm
60mm
65mm

RETRACTOR



A
CLOLOWWARADD-T-YTPYEPE
VERTEBRA SPREADERS



DB
CLOLWNGAREDLALMAMINIANA
SPREADERS



C
LNGE LAMINA
SPREADERS

VERTEBRA AND LAMINA SPREADERS

CLOWARD TYPE VERTEBRA SPREADERS

DEPTH
65mm
75mm
85mm

CLOWARD LAMINA SPREADERS

DEPTH
75MM

INGE LAMINA SPREADERS

LENGTH
16.5cm
28cm

RETRACTOR



CASPAR-TYPE

DISTRACTOR OVERLTYPE FBORRA LU SBEO DINY SURGICAL PROCEDURES

FROM THE RLEIGHFTH TA PAPPORAOCAHC HF OFRO RC 5C 5T HTRHORUOGUHG HT 1T 1(T (2T)2 A) NADN DF RFORMOM

THE RLEIGHFTH TA PAPPORAOCAHC HF OFRO RT HTEH EU PUPPEPRE RC ECREVRIVCIACLA LS PSTPIENE

DRDIRLLILGLUGIUDIED RE I G HT

B
SPCIRNEWDRDIVREIVRER



C
DITSWTRISATCTDIROINL LP ØIN 1 . 7 MM

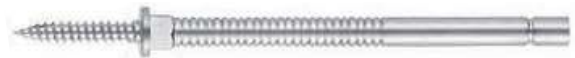

D
DITSWTRISATCTDIROINL LP I N

VERTEBRAL BODY DPINST DRIASCTTROARC TOR SYSTEM FOR ANTERIOR CERVICAL FUSION

DRILL
GUIDE

SCREW
DRIVER

DISTRACTION
PIN
LENGTH/SIZE

66/12mm
68/14mm
70/16mm
72/18mm

TWIST
DRILL

LENGTH DRILLING DEPTH

15m m 8 m m

RETRACTOR



CASPAR-TYPE

DISTRACTOR VERTEBRAL BODY
FROM THE LEFT APPROACH FOR C5 THROUGH T1 (T2) AND FROM
THE RIGHT APPROACH FOR THE UPPER CERVICAL SPINE

A
DRILLGUIDE LEFT

B
PIN DRIVER



C
TWISTDRILL Ø 1.7MM



D
DISTRACTION PIN

VERTEBRAL BODY DPINST DRIASCTTROARC TOR SYSTEM FOR ANTERIOR CERVICAL FUSION

DRILL
GUIDE

PIN
DRIVER

DISTRACTION
PIN

TWIST
DRILL

LENGTH/SIZE

66/12mm
68/14mm
70/16mm
72/18mm

LENGTH
15m m

DRILLING DEPTH
8 m m

RETRACTOR



CASPAR-TYPE
MICRO LUMBER DISCECTOMY RETRACTOR
FOR MICROSURGICAL TREATMENT OF HERNIATED



A
LUMBAR SPECULUM FENESTRATED



B
LATERALBLADES (blunt)

MICRO LUMBER DISCECTOMY RETRACTOR SYSTEM

LUMBAR SPECULUM FENESTRATED

LENGTH

50MM
55MM
60MM
65MM
70MM
75MM
80MM
85MM

LATERAL BLADES

LENGTH

55X15MM
60X15MM
65X15MM
70X15MM
75X15MM
80X15MM
85X15MM
90X15MM

RETRACTOR

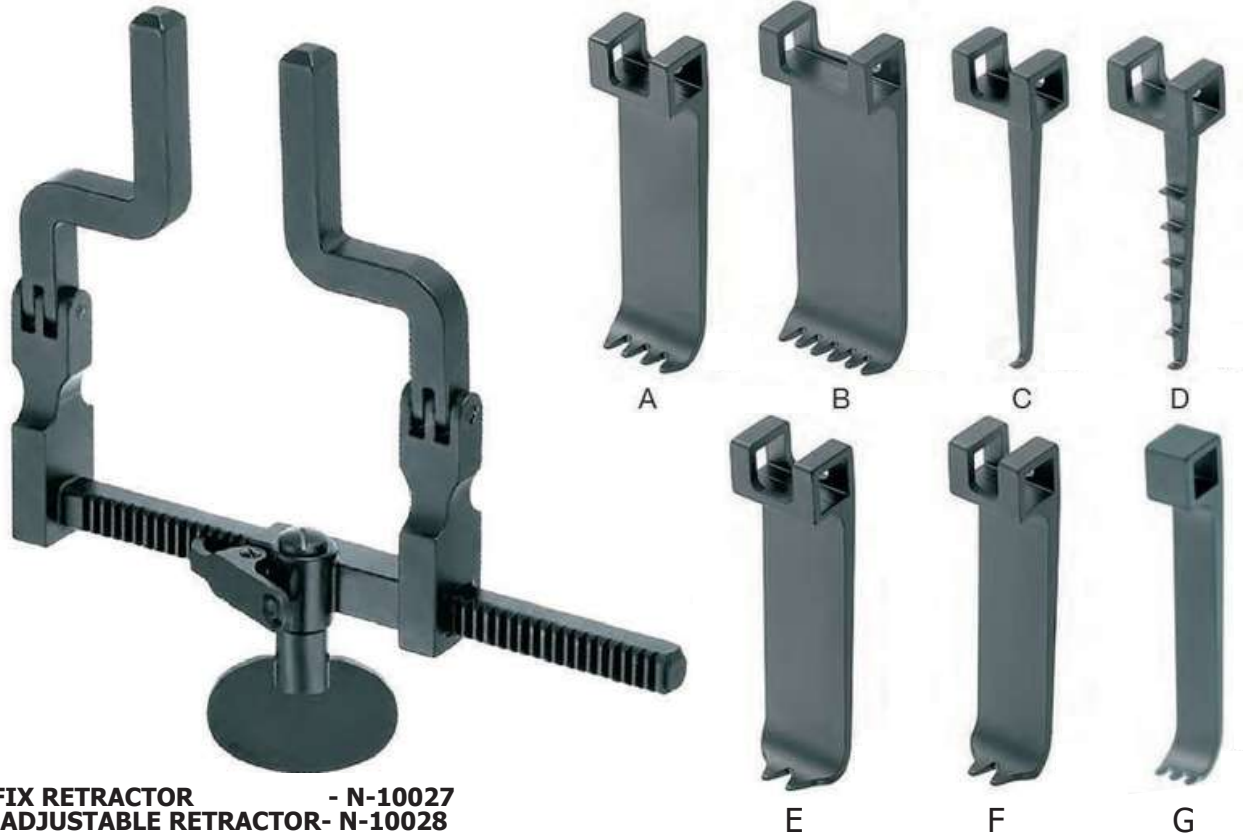

FIX RETRACTOR - N-10027
ADJUSTABLE RETRACTOR- N-10028

MICRO DDISSCCEECCTTOOMYY RREETTRRAACCTTOORR MCCULLOCH

NARROW MUSCLE BLADES
BLACK COATED 4-TEETH 20mm WIDTH

- LENGTH**
- 40mm
 - 50mm
 - 60mm
 - 70mm
 - 80mm
 - 90mm

WIDE MUSCLE BLADES

- LENGTH**
- 40mm
 - 50mm
 - 60mm
 - 70mm
 - 80mm
 - 90mm

HOOK BLADES

- LENGTH**
- 40mm
 - 50mm
 - 60mm
 - 70mm
 - 80mm
 - 90mm

HOOK BLADES

- LENGTH**
- 40mm
 - 50mm
 - 60mm
 - 70mm
 - 80mm
 - 90mm

RETRACTOR

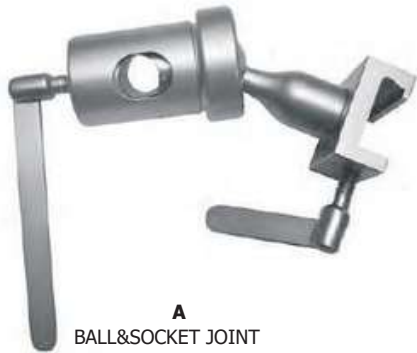

A
BALL & SOCKET JOINT



B
HOLDING ROD



C



D
FIXATION FOR SKULL
1 FLEXIBLE ARM



D
FIXATION FOR SKULL
2 FLEXIBLE ARM



E

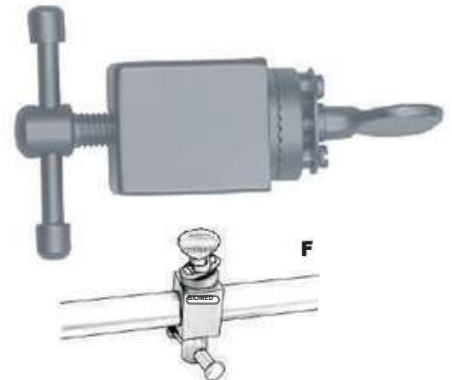

F

COUPLING HEAD
TO TAKE 1 – 5 FLEXIBLE

COUPLING HEAD
EQUAL TO N-9584 BUT
LATERALLY OPEN AND CAN
BE FIXED SUBSEQUENTLY
AT ANY POSITION ON THE
HOLDING ROD.

COUPLING HEAD
TURNABLE, CAN BE FIXED ANY
POSITION TO TAKE ONE
FLEXIBLE ARM, IF NECESSARY
SEVERAL COUPLING HEADS
CAN BE ATTACHED..

BALL & SOCKET JOINT
FOR FIXING HOLDING ROD TO POLE
OF OPERATING TABLE
MAX 9X32MM

HOLDING ROD
FOR FIXATION IN BALL- AND SOCKET
JOINT AND TO TAKE COUPLING HEAD

FIXATION BASE FOR SKULL
MOUNTING,
1 FLEXIBLE ARM
2 FLEXIBLE ARM

RETRACTOR



E
SUPPORT ONLY FOR FLAT



F
SUPPORT FLEXIBLE SPATULAS



G
FLEXIBLE ARM RETRACTOR

**SUPPORT ONLY FOR FLAT SPATULAS
FIXING TO FLEXIBLE ARM**

**SUPPORT ONLY FOR SPATULA
WITH ROUND SHAFT UP TO 5.5MM DIA
FIXING TO FLEXIBLE ARM**

**FLEXIBLE ARM ONLY FOR ATTACHING
COUPLING HEAD**



HEIFETZ BRAIN
ROUND SPATULA MALLEABLE S HAFT 15.5Cm

SIZE

- 8MM
- 11MM
- 14MM
- 17MM



MOD AACHEN
SPATULA MALLEABLE

SIZE

- 7+8MM
- 10+11MM
- 13+14MM
- 19+20MM

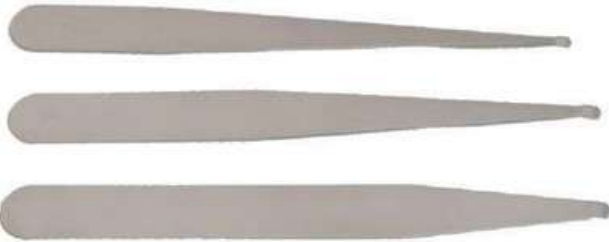

TAPERED BRAIN RETRACTOR
BLADE BEND (BLACK COATED)

TIP SIZE

- 2MM
- 4MM
- 6MM

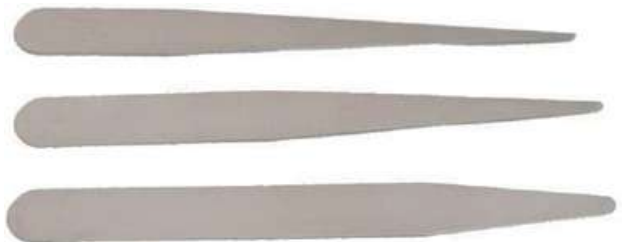

TAPERED BRAIN RETRACTOR
STRAIGHT (BLACK COATED)

TIP SIZE

- 2MM
- 4MM
- 6MM



DAVIS/RIBBON BRAIN MALLEABLE RETRACTOR

SIZE

- 6MM
- 8MM
- 10MM
- 12MM
- 14MM

SIZE

- 16MM
- 18MM
- 20MM
- 22MM
- 25MM

LEYLA RETRACTOR

LEYLA SET WITH TABLE MOUNT



FLEXIBLE ARM ONLY FOR ATTACHING COUPLING HEAD TO TAKE 1-5 FLEXIBLE COUPLING BASE



**BALL & SOCKET JOINT FOR FIXING HOLDING ROD TO POLE OF OPERATING TABLE
MAX 9X32MM**



**SUPPORT ONLY FOR FLAT SPATULAS
FIXING TO FLEXIBLE ARM**



**4MM
TAPERED RETRACTOR
STRAIGHT (BLACK COATED)**



**HOLDING ROD
FOR FIXATION IN BALL- AND SOCKET
JOINT AND TO TAKE COUPLING HEAD**

LEYLA SET WITH SKULL MOUNT



**4MM
TAPERED RETRACTOR
STRAIGHT (BLACK COATED)**



**FLEXIBLE ARM ONLY FOR ATTACHING
COUPLING BASE**



**FIXATION BASE FOR SKULL
MOUNTING,**



**FIXATION FOR SKULL
1 FLEXIBLE ARM**



**SUPPORT ONLY FOR FLAT SPATULAS
FIXING TO FLEXIBLE ARM**

RETRACTOR



SCOVILLE

HAVERFIELDHEMILEMINECTOMY RETRACTOR

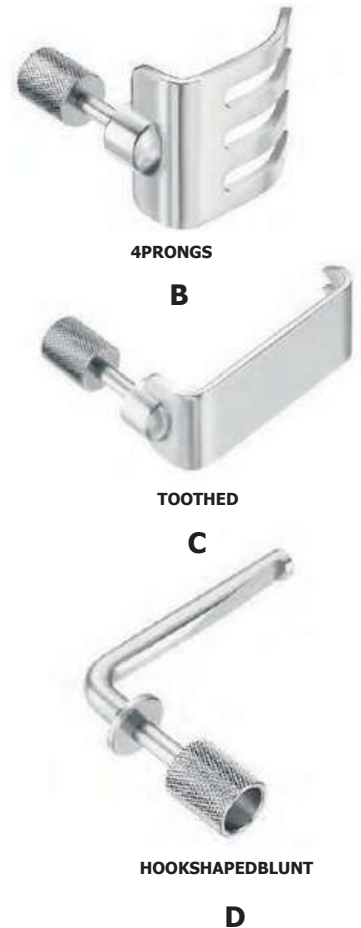

SCOVILLE RETRACTORS BLADES

4 PRONGS BLADES

SIZE

41mmx38mm
66mmx48mm
48mmx51mm
63mmx63mm
82mmx58mm

TOOTHED BLADES

SIZE

63mm x 26mm
66mm x 30mm
89mm x 26mm
51mm x 51mm
63mm x 51mm

HOOK SHAPED BLUNT BLADES

SIZE

50mm x 5mm
75mm x 5mm

RETRACTOR



SELF-RETAINING RETRACTORS

C O N E SELF-RETAINING

RETRACTOR

FIG. CAT NO. LENGTH

16cm 18mm 3x4 PRONGS SEMI SHARP
20cm 20mm 3x4 PRONGS SEMI SHARP
26cm 27mm 3x4 PRONGS SEMI SHARP

16cm 18mm 3x4 PRONGS BLUNT
20cm 20mm 3x4 PRONGS BLUNT
26cm 27mm 3x4 PRONGS BLUNT

WILLIAMS MICRODISCECTOMY

RETRACTOR, LENGTH 17CM
(LEFT & RIGHT)

LEFT

BLADE SIZE

50 x 10mm
70 x 10mm
50 x 20mm
70 x 20mm

RIGHT

AS SHOWN IN PICTURE ABOVE

BLADE SIZE

50 x 10mm
70 x 10mm
50 x 20mm
70 x 20mm

RETRACTOR



A A



B



C

SELF-RETAINING RETRACTORS

MINI WEITLANER RETRACTOR

LENGTH

11cm 16mm 2x3 PRONGS SEMI SHARP
11cm 16mm 2x3 PRONGS BLUNT

WEITLANER STRAIGHT RETRACTOR

LENGTH

13cm 18mm 3x4 PRONGS SEMI SHARP
16cm 18mm 3x4 PRONGS SEMI SHARP
20cm 21mm 3x4 PRONGS SEMI SHARP
25cm 27mm 3x4 PRONGS SEMI SHARP
20cm 21mm 4x5 PRONGS SEMI SHARP

LENGTH

13cm 18mm 3x4 PRONGS BLUNT
16cm 18mm 3x4 PRONGS BLUNT
20cm 21mm 3x4 PRONGS BLUNT
25cm 27mm 3x4 PRONGS BLUNT

WEITLANER CURVED RETRACTOR

LENGTH

20cm 21mm 3x4 PRONGS SEMI SHARP
25cm 27mm 3x4 PRONGS SEMI SHARP
20cm 21mm 4x5 PRONGS SEMI SHARP

ANDERSON ADSON CEREBELLAR RETRACTOR

FIG. CAT NO. LENGTH

| FIG. | CAT NO. | LENGTH |
|------|----------|------------------------------------|
| C | N° 10388 | 20 cm 16 mm 4 X 4 PRONGS SEMI SEMI |
| C | N° 10405 | 19 cm, 23mm 4x4 PRONG SIMI SHARP |

RETRACTOR



SELF-RETAINING RETRACTORS

WEITLANER STRAIGHT

RETRACTOR

LENGTH

26cm 27mm 5x6 PRONGS SEMI SHARP
26cm 27mm 5x6 PRONGS BLUNT

HEMILAMINECTOMY

RETRACTOR

LENGTH

29cm 42mm 6x6 PRONGS SEMI SHARP
29cm 42mm 6x6 PRONGS BLUNT

HEMILAMINECTOMY

RIGHTBLADE42mm,LEFTBLADE22mm DEPTH

LENGTH

29cm 22/42mm 6x6 PRONGS SEMI SHARP

WEITLANER CURVED

RETRACTOR

LENGTH

26cm 27mm 5x6 PRONGS SEMI SHARP

HEMILAMINECTOMY

RIGHTBLADE22mm,LEFTBLADE42mm DEPTH

LENGTH

29cm 22/42mm 6x6 PRONGS SEMI SHARP

RETRACTOR



A



B



C

SELF-RETAINING RETRACTORS

MOLLISON

RETRACTOR

LENGTH

14cm, 18mm 3x3 PRONGS SEMI SHARP
14cm, 18mm 3x3 PRONGS BLUNT
14cm, 18mm 3x4 PRONGS SEMISHARP
14cm, 18mm 3x4 PRONGS BLUNT
16.5cm, 18mm 3x4 PRONGS SEMISHARP
16.5cm, 18mm 3x4 PRONGS BLUNT

BECKMAN ADSON

LAMINECTOMY

LENGTH

31cm, 37mm 4x4 PRONGS SEMI SHARP
31cm, 48mm 4x4 PRONGS SEMI SHARP
31cm, 37mm 4x4 PRONGS BLUNT
31cm, 48mm 4x4 PRONGS BLUNT

BECKMAN EATON

LAMINECTOMY RETRACTOR

LENGTH

32cm, 50mm 7x7 PRONGS SEMI SHARP

RETRACTOR



A



B



C

SELF-RETAINING RETRACTORS

MISKIMONCEREBELLAR RETRACTOR

| FIG. | CAT NO. | LENGTH |
|------|---------|----------------------------------|
| A | N-10402 | 22cm, 35mm 7x7 PRONGS SHARP |
| A | N-10403 | 22cm, 35mm 7x7 PRONGS SIME SHARP |

ADSON CEREBELLAR RETRACTOR

| FIG. | CAT NO. | LENGTH |
|------|---------|-----------------------------|
| B | 7606 | 19cm, 23mm 4x4 PRONGS SHARP |
| B | 7607 | 19cm, 23mm 4x4 PRONGS BLUNT |

MAYO ADSON LAMINECTOMY RETRACTOR

| FIG. | CAT NO. | LENGTH |
|------|---------|----------------------------------|
| C | 7609 | 31cm, 27mm 4x5 PRONGS SIMI SHARP |
| C | 7608 | 31cm, 27mm 4x5 PRONGS BLUNT |

RETRACTOR



SELF-RETAINING RETRACTORS

CEREBELLAR

SELF-RETAINING RETRACTOR

| | |
|---------|---|
| N-10407 | 20cm, 27mm 4x5 STRAIGHT |
| N-9592 | 20cm, 27mm 4x5 CURVED (as shown above) |

GELPI SKIN RETRACTOR

| | | |
|---|---------|--------|
| B | N-9039 | LENGTH |
| B | N-10535 | 18.5cm |
| B | N-10536 | 14cm |
| | | 12cm |

BLADES ARE TEFLON COATED

| | | |
|---|---------|------|
| D | B-15123 | 18cm |
|---|---------|------|

JANSEN RETRACTOR

C 1049 3x3 PRONGS

RETRACTOR

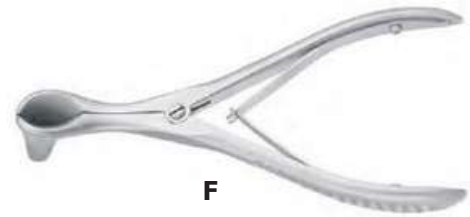
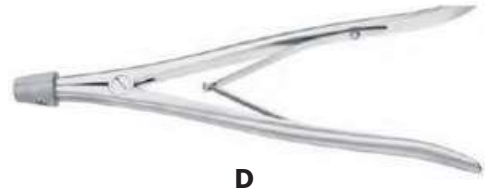
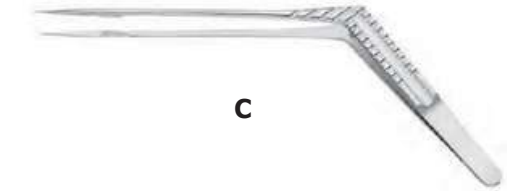

TRANS-SPHENOIDAL HYPOPHYSECTOMY

CUSHING LANDOLT SPECULUM

FIG.CATNO. LENGTH

| | | |
|---|---------|----------|
| A | N-10408 | 70X15mm |
| A | N-10409 | 90x15mm |
| A | N-10410 | 110x15mm |

TISSUE FORCEPS

FIG.CATNO. LENGTH

| | | |
|---|---------|---------------|
| C | N-10416 | 215MM, 8 1/2" |
|---|---------|---------------|

RETRACTOR

LOVE BAYONET NERVE

ROOT RETRACTOR 21cm

SIZE

4mm



KRAYENBUHL NERVE

ROOT RETRACTOR DOUBLE BAYONET

SIZE

3mm

4mm



CASPARBAYONET

NERVE ROOT RETRACTOR 24cm

SIZE

4mm

6mm



O'CONNELL NERVE

ROOT RETRACTOR 21.5cm LENGTH



LOVE NERVE

ROOT RETRACTOR 20cm 5mm TIP WIDTH

SIZE

STRAIGHT 5X5MM

25° ANGLED 5X5MM

90° ANGLED 5X5MM



MCCULLOCH NERVE

ROOT RETRACTOR 90°, 6mm TIP
WORKING LENGTH 12.5cm/5"

SIZE

6mm



RETRACTOR

SHEPPERED SUCTION

RETRACTOR, FIBEROPTIC ILLUMINATION
LENGTH 21CM- WORKING LENGTH-11CM

SIZE
4MM
6MM

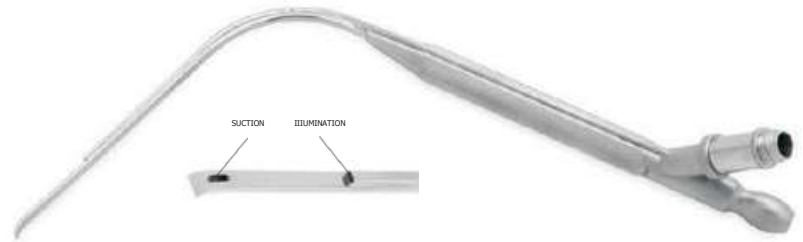

NERVE ROOT

RETRACTOR 31cm with SUCTION TIP
7mm Tip

SIZE
7mm

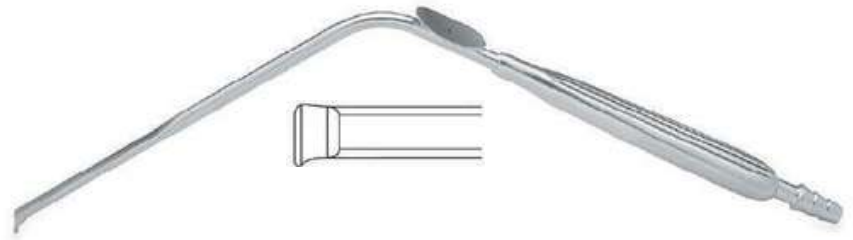

HESS NERVE

ROOT RETRACTOR 19cm, WORKING LENGTH-10CM

SIZE
3mm
4mm
5mm
7mm



HESS NERVE ROOT

RETRACTOR 19cm, WITH FIBEROPTIC LIGHT

SIZE
3mm
4mm
5mm
7mm



RETRACTOR

OBWEGESER DOWN RETRACTOR 21.5cm LENGTH

SIZE

18 x 5mm
25 x 7mm
35 x 10mm
42 x 10mm
55 x 12mm
70 x 14mm
80 x 16mm



LANGENBECK RETRACTOR 21.5cm LENGTH

SIZE

25x6mm
35x15mm
45x20mm
65x25mm
75x25mm
90x25mm



TAYLOR HIP RETRACTOR 19cm LENGTH

SIZE

70mm
85mm
100mm



VOLKMANN CATSPA W RETRACTOR SEMI SHARP TEETH

SIZE

3 PRONGS
4 PRONGS
6 PRONGS



15x15mm
3PRONGS



15x20mm
4PRONGS



15x30mm
6PRONGS

CLOWARD STYLE BLADERETRACTOR 18cm- **BLACK COATED**

| CAT NO. | SIZE |
|---------|------|
| N-10438 | 14mm |
| N-10439 | 18mm |
| N-10440 | 20mm |
| N-10137 | 23mm |



RETRACTOR



COTTLE
RETRACTOR
BLUNT



COTTLE
RETRACTOR
SHARP



COTTLE UPPER
RETRACTOR



JOSEPH
RETRACTOR
FINE SHARP



GILLIES
SKIN HOOK

MICRO FINE

3mm

5mm



COTTLE UPPER
TITANIUM COATED RETRACTOR



ROLLET RETRACTOR
4 SHARP PRONGS



KILNER
RETRACTOR



SHARP



BLUNT



RAGNELL RETRACTOR
16cm

RETRACTOR



KILLIAN NASAL SPECULUM
5cm, 6.5cm, 7.5cm, 9cm

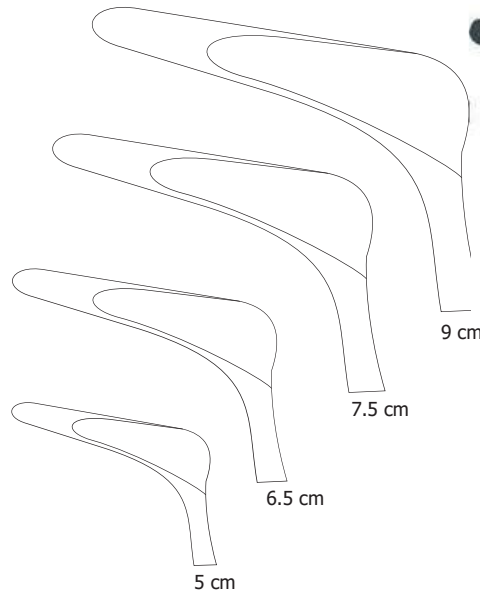

COTTLE KILLIAN NASAL SPECULUM

BLACK COATED
5CM 6.5CM, 7.5CM, 9CM

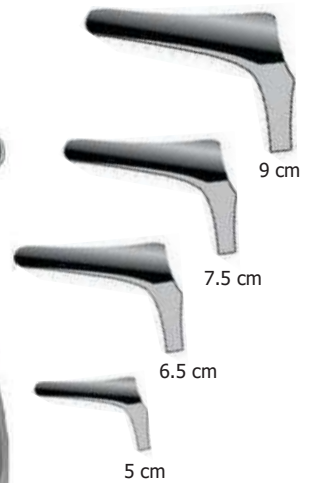

KILLIAN NASAL SPECULUM
WITH FIBER OPTIC LIGHT



CALIPER
STRAIGHT
S.S



CALIPER
CURVED

OSTEOTOME

OSTEOTOME, FIBER HANDLE

LENGTH- 25cm 9 3/4"

SIZE

5 mm
8 mm
10mm
12mm
14mm
16mm
18mm
20mm
25mm
30mm



CHISELS, FIBER HANDLE

LENGTH- 25cm 9 3/4"

SIZE

5 mm
8 mm
10 mm
14 mm
15 mm
18 mm
20mm
22mm
25mm
30mm



GOUGE, FIBER HANDLE

LENGTH- 25cm 9 3/4"

SIZE

5 mm
8 mm
10 mm
12 mm
14 mm
15 mm
16 mm
18 mm
20 mm
25 mm
30mm



LEXER OSTEOTOME

22cm 8 1/2" TUFNOL HANDLE

SIZE

7mm
10mm
15mm
20mm
25mm
30mm



SCAGLIETTI OSTEOTOME

SIZE

6mm
9mm
12mm
16mm
19mm



MINI STILLE OSTEOTOME

SIZE

- 2 m m 2mm
- 3 m m 3mm
- 4 m m 4mm
- 6 m m 6mm
- 8 m m 8mm
- 10 m m 10mm



STILLE OSTEOTOME

SIZE

- 6MM
- 8MM
- 10MM
- 12MM
- 14MM
- 18MM
- 22MM



MEINIS USTRILNLGE OSTEOTOME

SIZE

- 2mm
- 3mm
- 4mm
- 5mm
- 6mm



STILLE CHISEL

SIZE

- 6MM
- 8MM
- 10MM
- 12MM
- 14MM
- 18MM
- 22MM



LAMBOTTE OSTEOTOME

SIZE

- 4mm
- 6mm
- 8mm
- 13mm
- 16mm
- 18mm
- 20mm
- 25mm
- 30mm

SIZE

- 4mm
- 6mm
- 8mm
- 13mm
- 16mm
- 18mm
- 20mm
- 25mm
- 30mm



OSTEOTOME

SMITH PETERSON

GOUGE

25cm 9¾" LENGTH

SIZE

6mm
9mm
13mm
16mm
19mm
25mm
32mm



SMITH PETERSON

OSTEOTOME

SIZE

| | | |
|----|-----|------|
| 10 | m m | 10mm |
| 15 | m m | 15mm |
| 20 | m m | 20mm |
| 25 | m m | 25mm |
| 30 | m m | 30mm |



KILLIAN GOUGE

S,1T6RcAmI GLHENT G1T6Hcm6¼"

SIZE

4mm
5mm



TILLEY SEPTUM GOUGE

SIZE

4mm
5mm



SILVER CHISEL

16cm 6¼"

SHAPE

STRAIGHT
RIGHT
LEFT



HAMMER

TOFFEEMALLET

24.5cm , 200 G
30mm WITH INTERCHANGEABLE
PLASTIC DISC



COTTLEMALLET

LENGTH
19cm/7½"



CLWARDTYPEMALLET

19MM,220G 7 1/2"
25MM,340G 9"

LENGTH
7½"
9"



MALLET WITH FERROZELLHANDLE

LENGTH
23cm/9"



OMBREDANNEMALLET

LENGTH
24cm/9½"



COBB SPINAL ELEVATOR

31cm 12¼" OVERALL LENGTH 18cm HANDLE

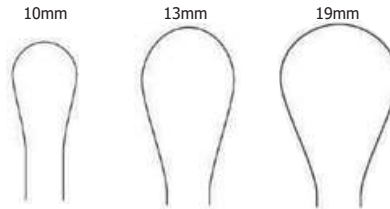

COB SPINAL ELEVATOR

EXTRA LONG HANDLE, 34cm 13½" OVERALL LENGTH 22cm 8¾" HANDLE LENGTH



ZIELKE S-SHAPED GOUGE

23cm/9" LENGTH

SIZE
6mm
9mm
6mm
9mm



COBB SPINAL GOUGE

31CM/12½" LENGTH

SIZE
6mm
6mm



CAPENER LAMINA GOUGE

23cm/9" LENGTH CRANKED SHAFT



ELEVATION



FREER 19CM
ELEVATOR BROAD



FREER,19CM
ELEVATOR FINE



FREER,19CM
ELEVATOR



MASING,19CM
ELEVATOR GRADUATED



HOWARTH,19CM
ELEVATOR



DISSECTOR ,20CM
WITH SUCCER



COHEN,19CM
ELEVATOR



WOODSON DURAL,19CM
SEPARATOR & PACKER ,



WATSON CHEYENE 19CM
DOUBLE ENDED
PROBE DISSECTOR



DAVISDISSECTOR
24CM

ELEVATION

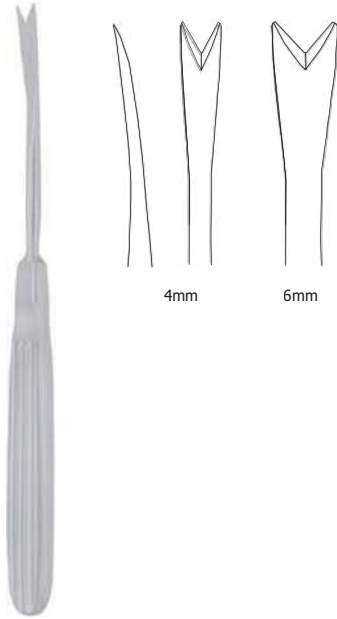

**OBWEGESER
(V SHAPE)**
RASPATORIEN 18CM

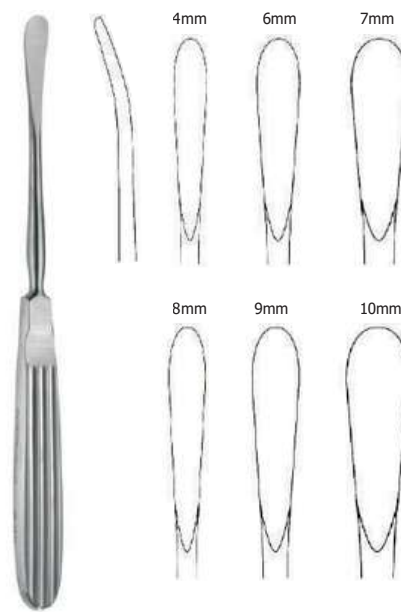

ADSON PRIOSTEAL
ELEVATOR 18CM



CUSHING
ELEVATOR SQUARE EDGE
19CM/TIP 16MM

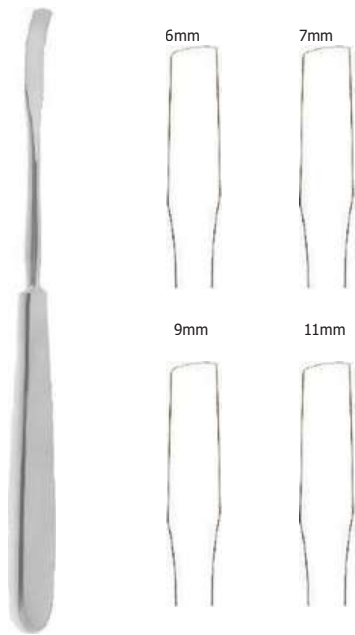

OBWEGESER
RASPATORIEN- 18CM

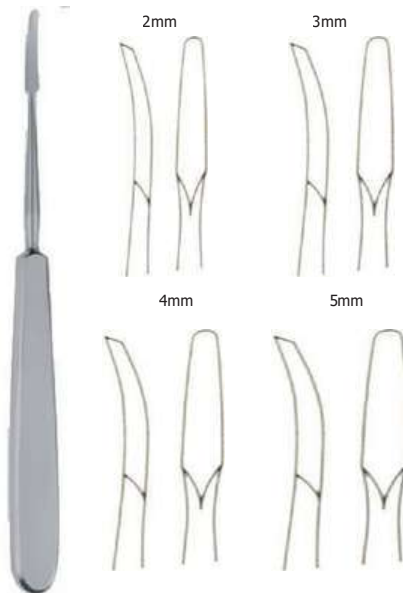

**RASPATORIEN
(SHARP)-18CM**



CUSHING
ELEVATOR ROUND EDGE
19CM/TIP 16MM

CURETTE

LAMPERT CURETTE

STRAIGHT/ANGLED 21cm/8 1/4"



STRAIGHT

SIZE
1.0mm
1.5mm
2.0mm
2.5mm
3.0mm
3.5mm
4.0mm
4.5mm
5.0mm



ANGLED

SIZE
1.0mm
1.5mm
2.0mm
2.5mm
3.0mm
3.5mm
4.0mm
4.5mm
5.0mm

BRUNS CURETTE

STRAIGHT/ANGLED 10"



STRAIGHT

SIZE
2.5MM
3.0MM
3.5MM
4.0MM
4.5MM
5.0MM



ANGLED

SIZE
2.5MM
3.0MM
3.5MM
4.0MM
4.5MM
5.0MM



DOWN

SIZE
1.5MM
2.0MM
2.5MM
3.0MM
3.5MM
4.0MM
4.5MM
5.0MM

LONG SPINAL

MICRO CURETTE 25CM/10"



STRAIGHT

SIZE
3MM
4MM
5MM



ANGLED

SIZE
3MM
4MM
5MM

CLONBGB SAPNITNEARLI OR

CURETTE 3289cm/151"1/2"
OVERALL LENGTH



STRAIGHT

SIZE
3mm
4mm
5mm
6mm
7mm
8mm



ANGLED

SIZE
3mm
4mm
5mm
6mm
7mm
8mm

CURETTE

VOLKMANN DOUBLE ENDED CURETTE 22CM

SIZE
3MM/5MM
4MM/6MM
5MM/7MM



CLOWARDRINGCURETTE

STRAIGHT 3mm
STRAIGHT 6mm
STRAIGHT 8mm
ANGLED 3mm
ANGLED 6mm
ANGLED 8mm



CERVICAL BONE GRAFT

6mmx12mm TIP 90°
3.5mmx6mm TIP 90°
7mmx13mm TIP 30°



CASPER BONE GRFT IMPACTOR 8"/20CM

3mm
5mm
8mm



CLOWARD TYPE BONE GRAFT IMPACTOR, DOUBLE ENDED 11/14MM



CLOWARD TYPE GAUGE GRAFT IMPACTOR, DOUBLE ENDED 11/14MM



FAIRGRIP BAYONET CURETTE STYLE



LUMBAR LONG SET (LARGER ANATOMY)

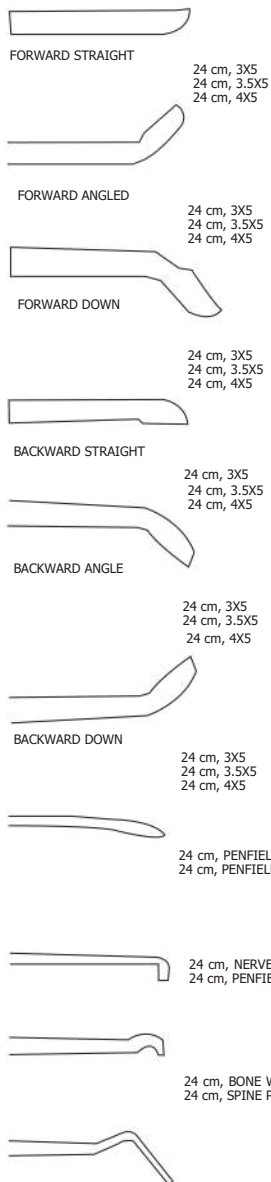

CURETTE DIMENSION CHART (ACTUAL SIZE SHOWN)

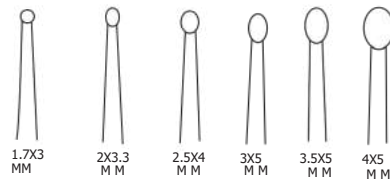

CERVICAL SET (SMALL ANATOMY)

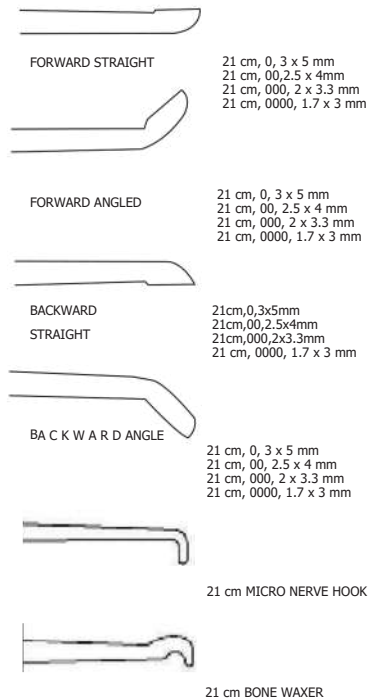

MICRO SCISSORS



MICRO SPRING SCISSORS
ANGLED 17 cm

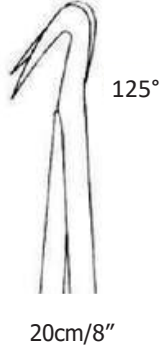

1 PROBE POINTED BLADE



NEGAL

YASARGIL MICRO SCISSORS BAYONET SHAPE



STRAIGHT

16.5cm/ 6½"
20cm/8"



UPWARD

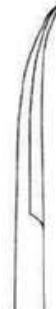

DOWNWARD

MICRO DISSECTING SCISSORS



STRAIGHT

20cm/8"
22.5cm/9"



UPWARD

20cm/8"
22.5cm/9"

MICRO FINE TIP



STRAIGHT

VANNAS
22.5cm/9"



UPWARD

VANNAS
22.5cm/9"



YASARGIL

MICRO SCISSORS

MICRO SPRING SCISSORS FLAT HANDLE

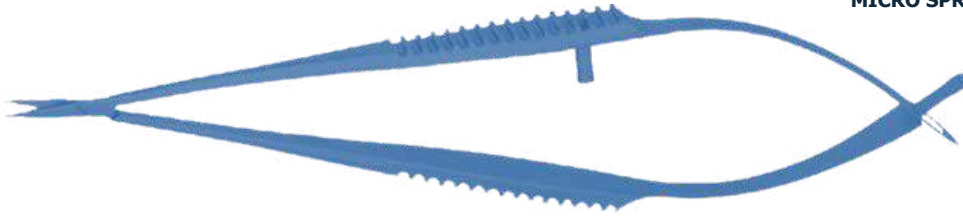

| | SIZE |
|----------|------|
| S.S | 6" |
| T.C | 6" |
| TITANIUM | 6" |

| | SIZE |
|----------|------|
| S.S | 7" |
| T.C | 7" |
| TITANIUM | 7" |

| | SIZE |
|----------|------|
| S.S | 8" |
| T.C | 8" |
| TITANIUM | 8" |

MICRO SCISSORS SPRING ROUND HANDLE



| | SIZE |
|----------|------|
| S.S | 6" |
| T.C | 6" |
| TITANIUM | 6" |

| | SIZE |
|----------|------|
| S.S | 7" |
| T.C | 7" |
| TITANIUM | 7" |

| | SIZE |
|----------|------|
| S.S | 8" |
| T.C | 8" |
| TITANIUM | 8" |

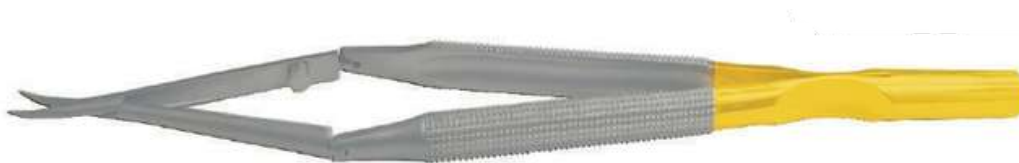

MICRO SCISSORS

YASARGIL MICRO SCISSORS BAYONET SHAPE



YASARGIL



UPWARD
22.5cm/9"

TITANIUM



STRAIGHT
22.5cm/9"

TITANIUM



DOWNWARD
22.5cm/9"



UPWARD
22.5cm / 9"
24.5cm/9¾"
22.5cm/9"

T.C



STRAIGHT
22.5CM
24.5CM
22.5CM

T.C



YASARGIL

SCISSORS



JAMISON METZENBAUM
SCISSORS NARROW TIP BLUNT CURVED

9"
7"
6"

T.C



SCHMIEDEN-TAYLOR
DURA SCISSOR 15,5CM, 6"

S.S
T.C

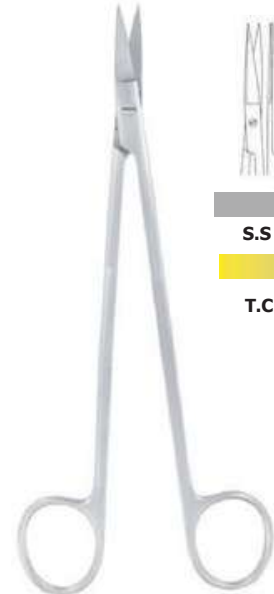

KELLY SCISSORS
STRAIGHT 16cm 6 1/4"

S.S
T.C



STEVENS SCISSORS
CURVED

4 1/2"

S.S

STEVENS SCISSORS
STRAIGHT

4 1/2"

S.S



STEVENS SCISSORS
CURVED

4 1/2"

5 1/2"

T.C

STEVENS SCISSORS
STRAIGHT

4 1/2"

5 1/2"

T.C

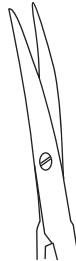

STEVENS SCISSORS
CURVED

4 1/2"

5 1/2"

S.C



STEVENS SCISSORS
STRAIGHT

4 1/2"

5 1/2"

S.C

SCISSORS



KNAPP SCISSORS
CURVED
4 1/2"
S.S



KNAPP SCISSORS
CURVED
4 1/2"
5 1/2"
T.C



KNAPP SCISSORS
CURVED
4 1/2"
5 1/2"
S.C

KNAPP SCISSORS
STRAIGHT
4 1/2"
S.S

KNAPP SCISSORS
STRAIGHT
4 1/2"
5 1/2"
T.C

KNAPP SCISSORS
STRAIGHT
4 1/2"
5 1/2"
S.C



IRIS SCISSORS
CURVED
3 1/2"
4"
5"
S.S



IRIS SCISSORS
CURVED
3 1/2"
4"
5"
T.C



IRIS SCISSORS
CURVED
4"
5"
S.C

IRIS SCISSORS
STRAIGHT
3 1/2"
4"
5"
S.S

IRIS SCISSORS
STRAIGHT
3 1/2"
4"
5"
T.C

IRIS SCISSORS
STRAIGHT
4"
5"
S.C

SCISSORS

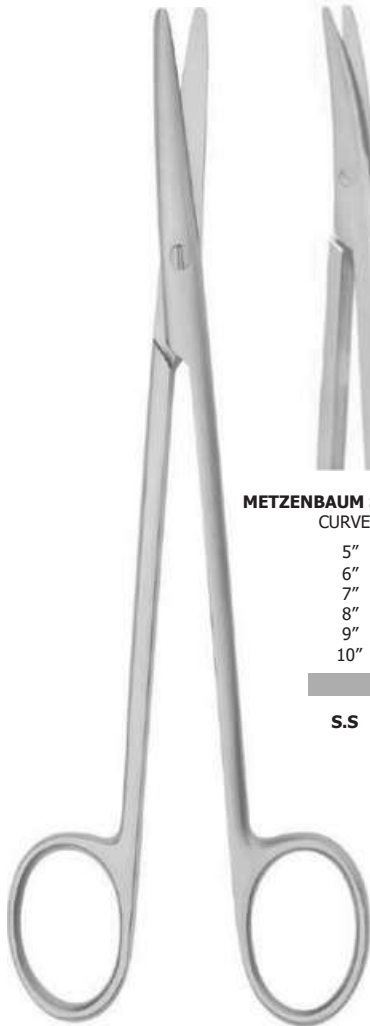

METZENBAUM SCISSORS
CURVED

5"
6"
7"
8"
9"
10"



S.S

METZENBAUM SCISSORS
STRAIGHT

5"
6"
7"
8"
9"
10"



S.S



METZENBAUM SCISSORS
CURVED

6"
7"
8"



T.C

METZENBAUM SCISSORS
STRAIGHT

6"
7"
8"



T.C

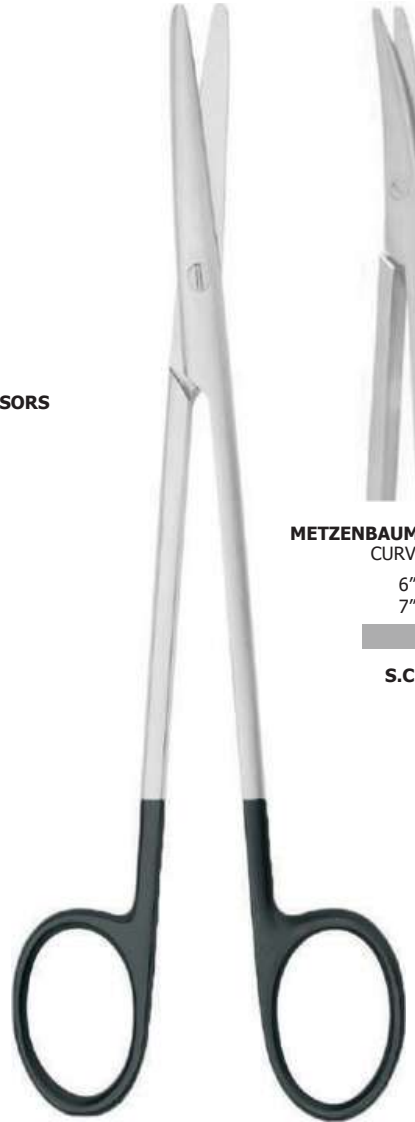

METZENBAUM SCISSORS
CURVED

6"
7"



S.C

METZENBAUM SCISSORS
STRAIGHT

6"
7"



S.C

SCISSORS



MAYO SCISSORS
STRAIGHT

5½"
6½"
7½"
8½"
9½"
10½"



S.S



MAYO SCISSORS
CURVED

5½"
6½"
7½"
8½"
9½"
10½"



S.S

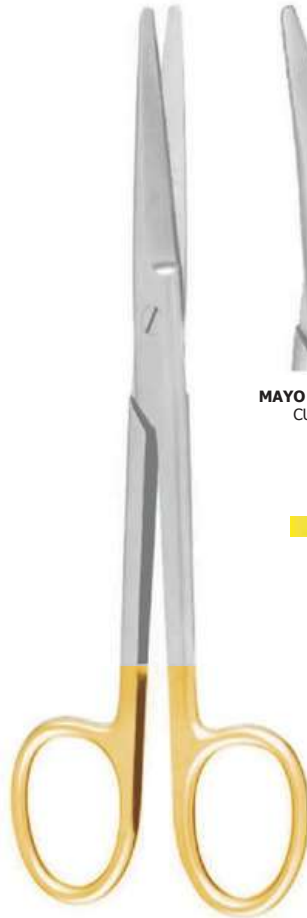

MAYO SCISSORS
STRAIGHT

5½"
6½"
7½"
8½"



T.C



MAYO SCISSORS
CURVED

5½"
6½"
7½"
8½"



T.C

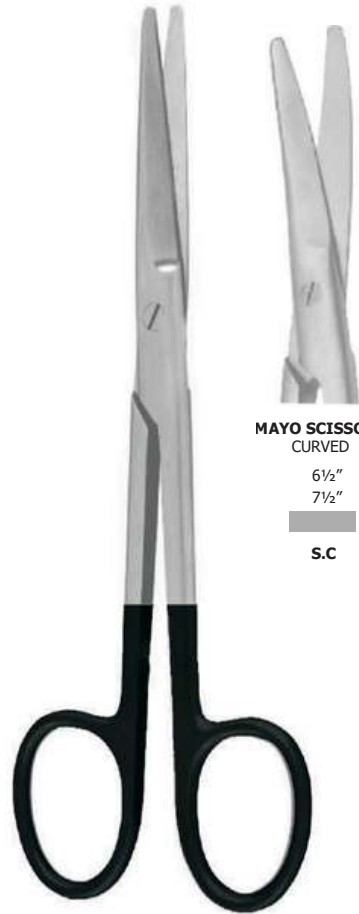

MAYO SCISSORS
STRAIGHT

6½"
7½"



S.C



MAYO SCISSORS
CURVED

6½"
7½"



S.C

SCISSORS

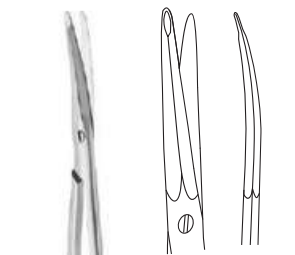

GORNEY
FACE LIFT SCISSORS 19cm
T.C.



T.C.



METZENBAUM S SHAPE
DISSECTING SCISSORS 8"
T.C.



T.C.



30° T.C. 45° T.C. 60° T.C.



POTT'S ANGLED
SCISSORS 8"



90° T.C. 125° T.C.



METZENBAUM
FINE TIP SCISSORS
CURVED

15cm
18cm
20cm

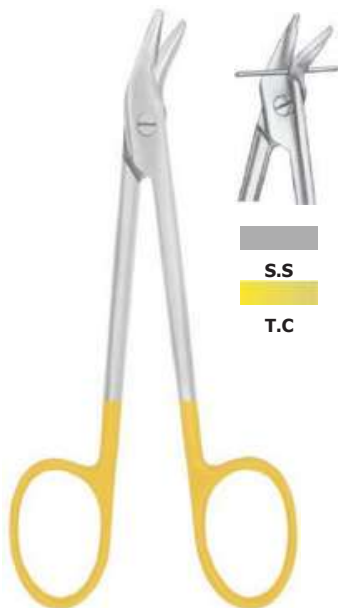

WIRE CUTTER
SCISSORS



S.S

T.C

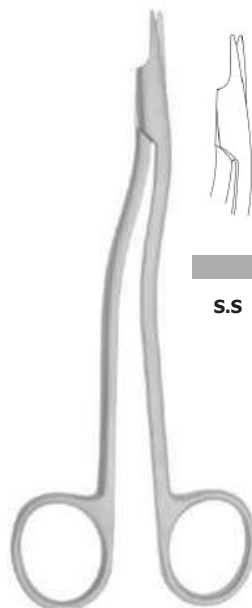

HEATH SUTURE
REMOVAL SCISSORS



S.S



LISTER BANDAGE
SCISSORS

5 1/2"
7 1/2"

S.S

FORCEPS

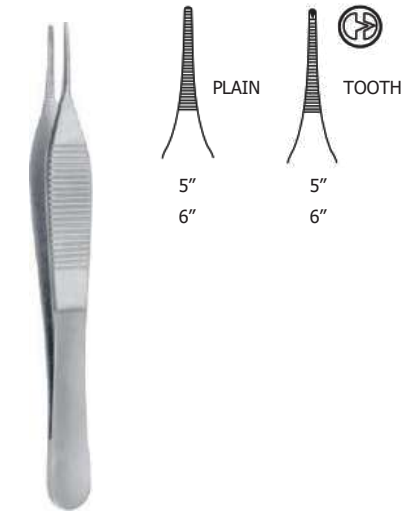

ADSON FORCEPS



ADSON FORCEPS

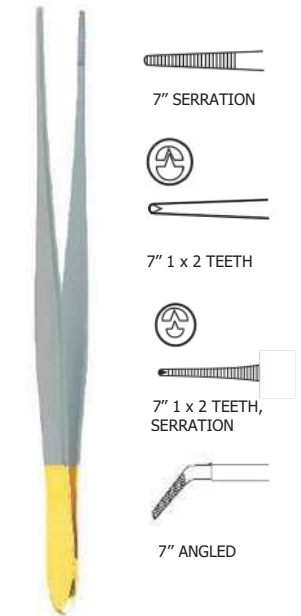

CUSHING FORCEPS SEMI SHARP
DISSECTING END GUTSCH HANDLE

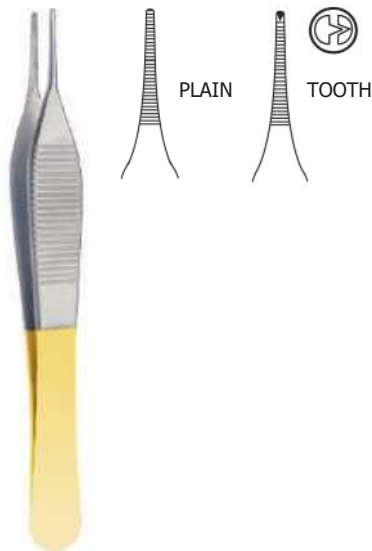

ADSON FORCEPS
PLAIN- 5"
Fine

T.C

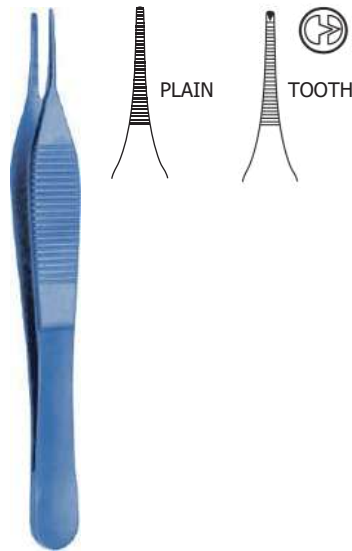

ADSON FORCEPS
PLAIN- 5"
Fine

TITANIUM

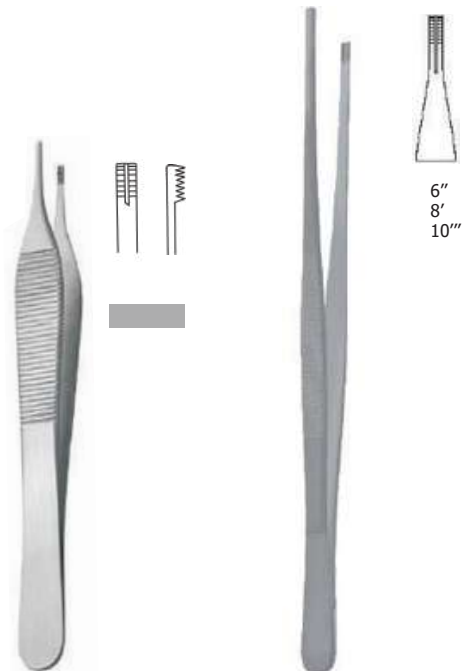

ADSON BROWN
FORCEPS 5"

BROWN FORCEPS
8 x 8 TEETH H

FORCEPS

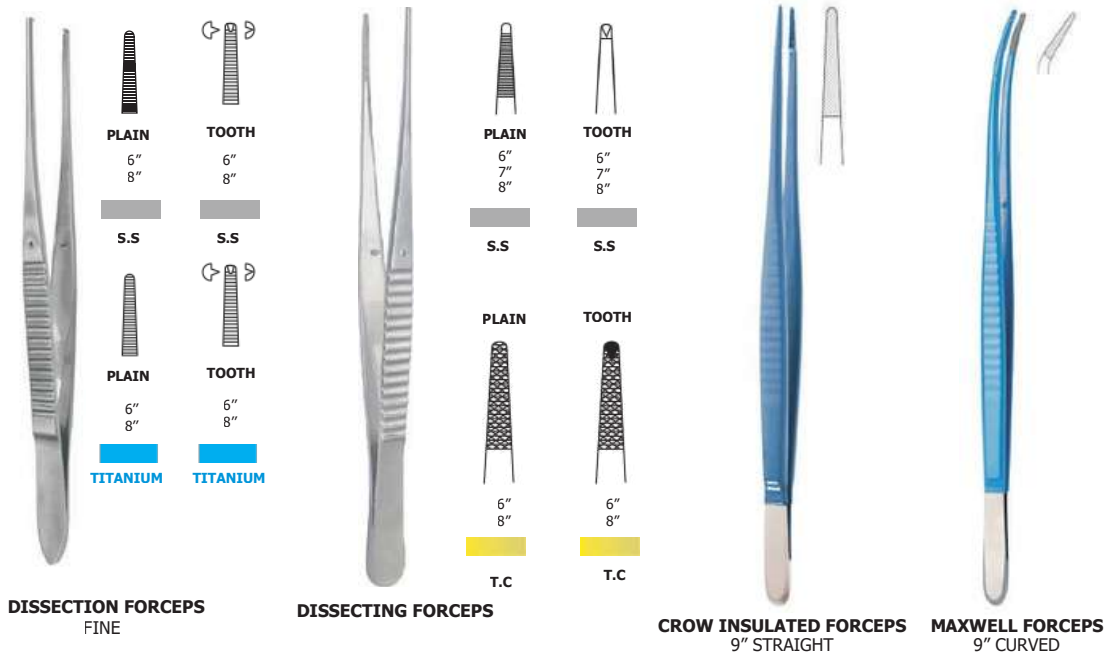

DISSECTION FORCEPS
FINE

DISSECTING FORCEPS

CROW INSULATED FORCEPS
9" STRAIGHT



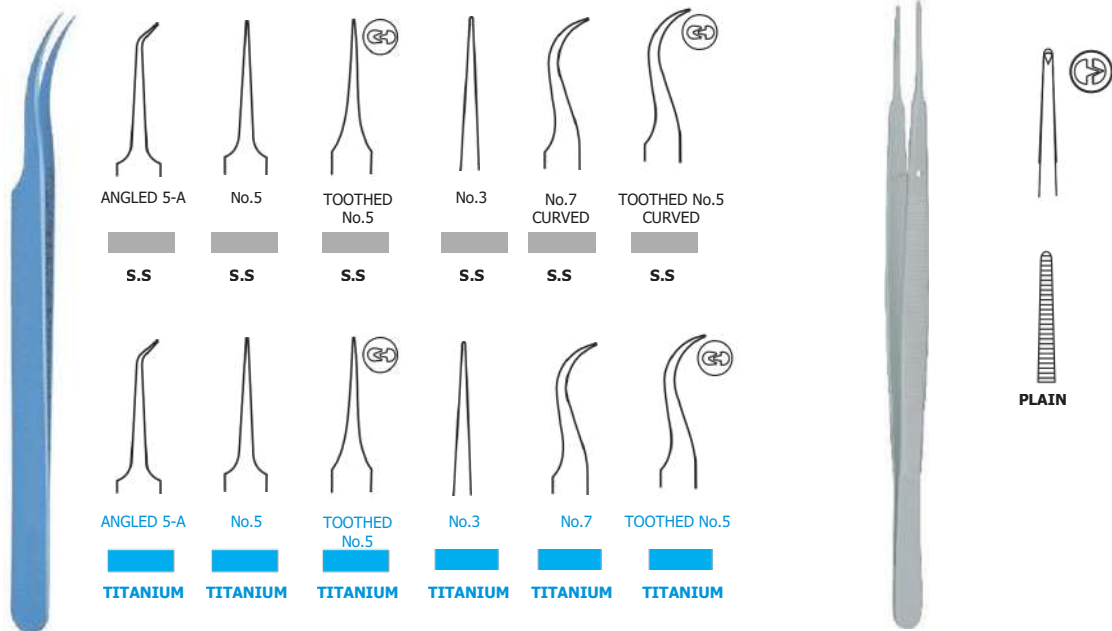













MAXWELL FORCEPS
9" CURVED









MICRO JEWELERS
FORCEPS

GERALD FORCEPS
STRAIGHT NARROW 7"

FORCEPS

| | | | | | | | | | | | |
|---|---|---|---|---|---|---|---|---|---|---|---|
|  |  |  |  |  |  |  |  |  |  |  |  |
| | PLAIN STRAIGHT | PLAIN CURVED | TEETH STRAIGHT | TEETH CURVED | | | PLAIN STRAIGHT | PLAIN CURVED | TEETH STRAIGHT | TEETH CURVED | |
| | 6" 8" | 6" 8" | 6" 8" | 6" 8" | | | 6" 8" | 6" 8" | 6" 8" | 6" 8" | |
| |  DIAMOND |  DIAMOND | | | | | |  DIAMOND |  DIAMOND | | |

MICRO FORCEPS ROUND HANDLE PLATFORM TIP **MICRO FORCEPS FLAT HANDLE PLATFORM TIP**

| | | | | |
|--|---|---|--|---|
|  |  |  |  |  |
| JANSEN BAYONET FORCEPS PLAIN | JANSEN BAYONET FORCEPS PLAIN 6" | JANSEN BAYONET FORCEPS 1x2 TOOTH | WILDE AURAL FORCEPS | NELSON TISSUE FORCEPS |
| 6" 7" 8" |  T.C | 6" 8" | | 6" 8" |

DEBAKEY FORCEPS & CLAMPS

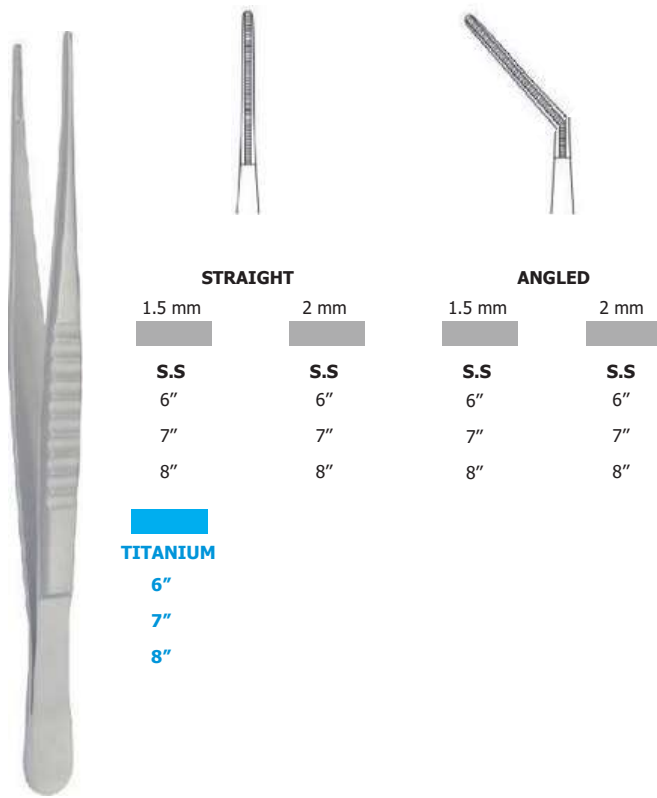

| STRAIGHT | | ANGLED | |
|-----------------|------------|------------|------------|
| 1.5 mm | 2 mm | 1.5 mm | 2 mm |
| S.S | S.S | S.S | S.S |
| 6" | 6" | 6" | 6" |
| 7" | 7" | 7" | 7" |
| 8" | 8" | 8" | 8" |
| TITANIUM | | | |
| 6" | | | |
| 7" | | | |
| 8" | | | |

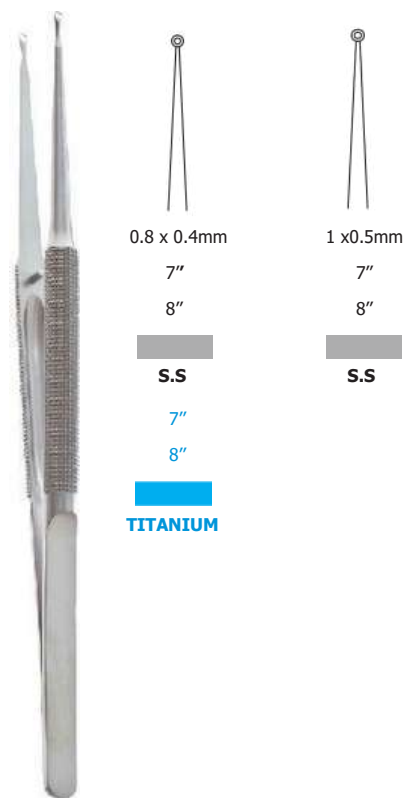

| | |
|-----------------|------------|
| 0.8 x 0.4mm | 1 x 0.5mm |
| 7" | 7" |
| 8" | 8" |
| S.S | S.S |
| 7" | |
| 8" | |
| TITANIUM | |

DEBAKEY VASCULAR FORCEPS

MICRO RING FORCEPS ROUND HANDLE



Debakey Bulldog Clamps

Glover Bulldog Clamps
Closing Pressure Adjustable

Overall Length
Jaw Length
STRAIGHT

| | | | | | | |
|-----|-----|------|-------|-----|------|------|
| 80m | 90m | 105m | 125mm | 47m | 51mm | 57mm |
| m | m | m | mm | m | mm | mm |
| 20m | 30m | 45m | 68mm | 10m | 14mm | 20mm |
| m | m | | | | | |

| | | | |
|------|------|------|-------|
| 50mm | 68mm | 85mm | 105mm |
| 20mm | 30mm | 40mm | 56mm |

Overall Length
Jaw Length
CURVED

| | | | | | | | | | | |
|------|-----|------|-------|------|------|------|------|------|------|-------|
| 75 m | 85m | 95 m | 115mm | 44mm | 46mm | 49mm | 46mm | 64mm | 78mm | 100mm |
| m | m | m | mm | mm | mm | mm | mm | mm | mm | mm |
| 20 m | 30m | 45 m | 68mm | 10mm | 14mm | 20mm | 20mm | 30mm | 43mm | 56mm |

CLAMPS

MICRO VASCULAR CLAMPS



MICRO APPLY CLAMPS SINGLE



MICRO APPLY CLAMPS DOUBLE



MICRO APPLY CLAMPS DOUBLE WITH FRAME

V
A



CLAMP SIZE
0.4-1.0mm

V
A

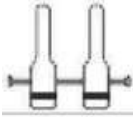

CLAMP SIZE
0.4-1.0mm

V
A



CLAMP SIZE
0.4-1.0mm

V
A



0.6-1.5mm

V
A

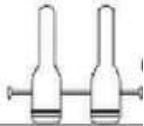

0.6-1.5mm

V
A



0.6-1.5mm

V
A



1.0-2.25mm

V
A

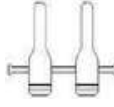

1.0-2.25mm

V
A



1.0-2.25mm

V
A



1.5-3.5mm

V
A

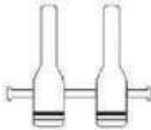

1.5-3.5mm

V
A



2.0-5.0mm

V
A

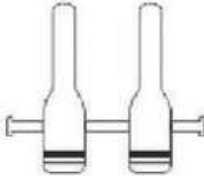

2.0-5.0mm



CLAMP APPLICATOR

NEEDLE HOLDER

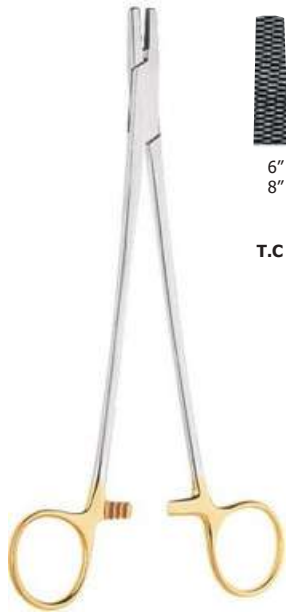

6"
8"

T.C

WIRE TWISTER

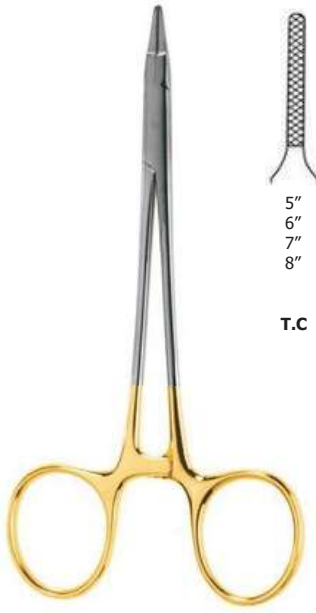

5"
6"
7"
8"

T.C

RYDER NEEDLE HOLDER

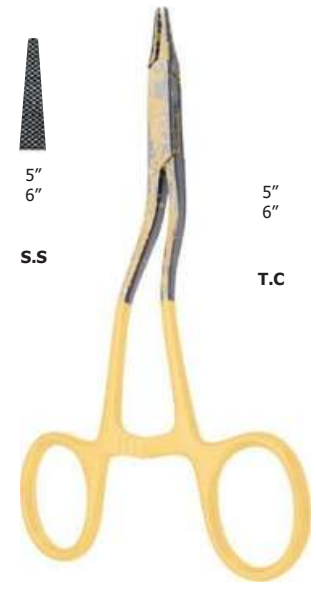

5"
6"

S.S

5"
6"

T.C

KILNER NEEDLE HOLDER

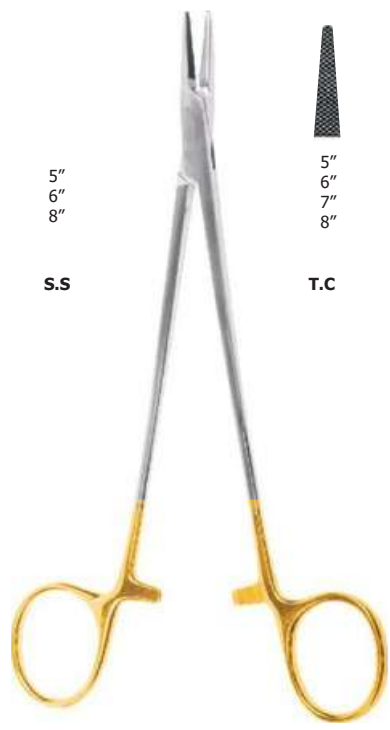

5"
6"
8"

S.S

5"
6"
7"
8"

T.C

MICRO VASCULAR NEEDLE HOLDER

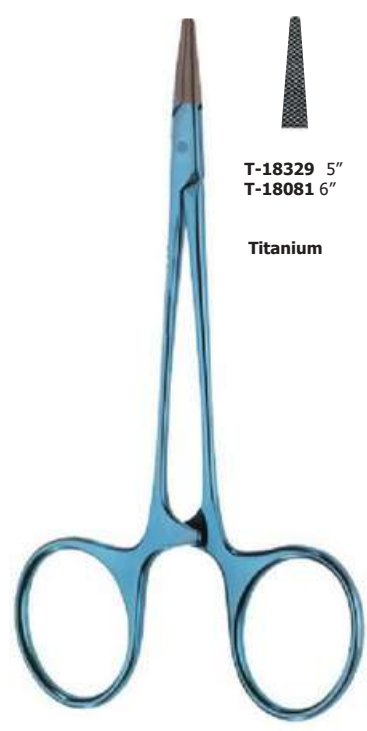

T-18329 5"
T-18081 6"

Titanium

MICRO VASCULAR NEEDLE HOLDER

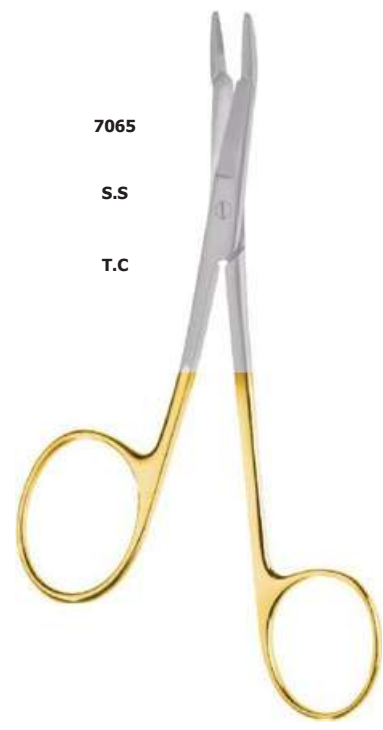

7065

S.S

T.C

OLSEN HAGAR NEEDLE HOLDER

NEEDLE HOLDER

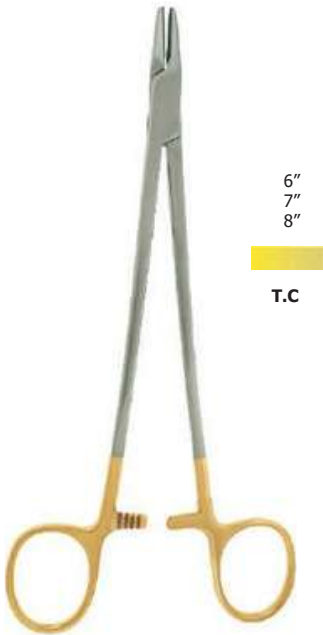

6"
7"
8"

T.C

MAYO NEEDLE HOLDER

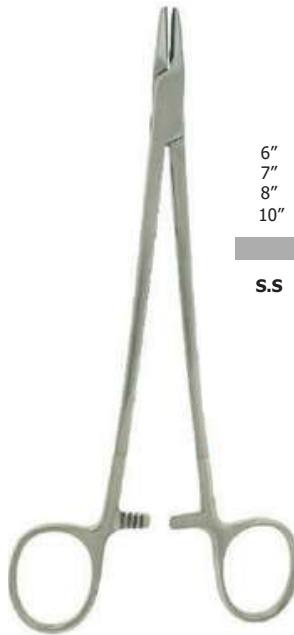

6"
7"
8"
10"

S.S

MAYO NEEDLE HOLDER

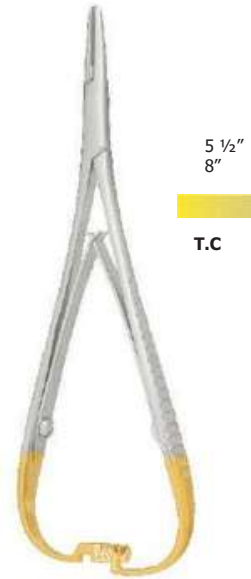

5 1/2"
8"

T.C

MATHIEU NEEDLE HOLDER

FINE MICRO SPRING NEEDLE HOLDER FLAT HANDLE



NEEDLE HOLDER



MICRO SPRING NEEDLE HOLDER FLAT HANDLE



MICRO SPRINGNEEDLE HOLDER ROUND HANDLE

NEEDLE HOLDER

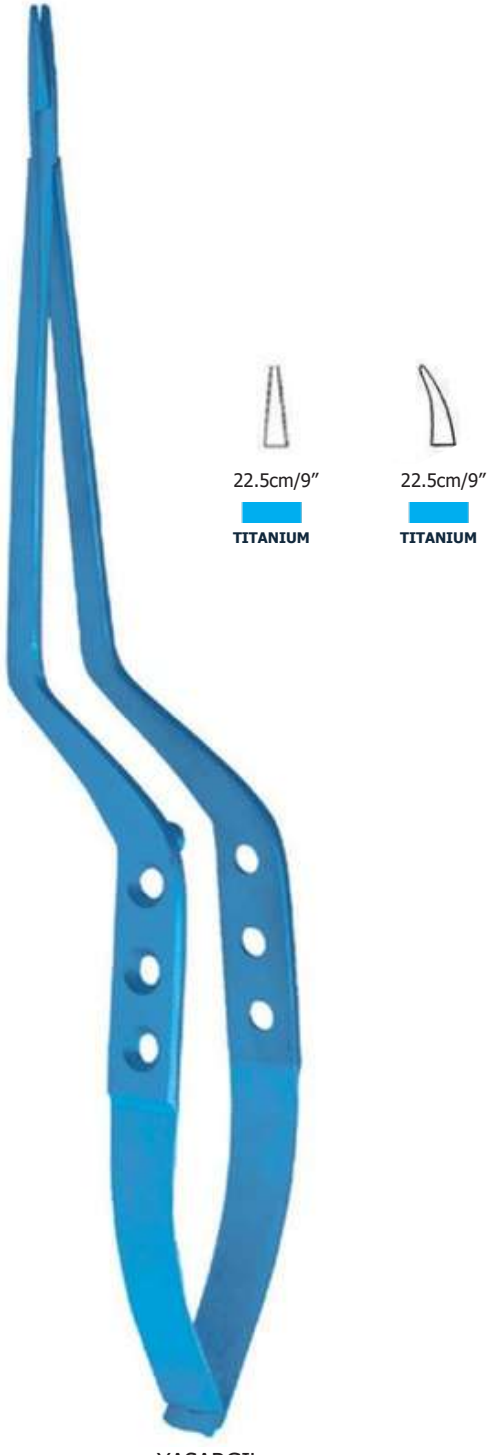
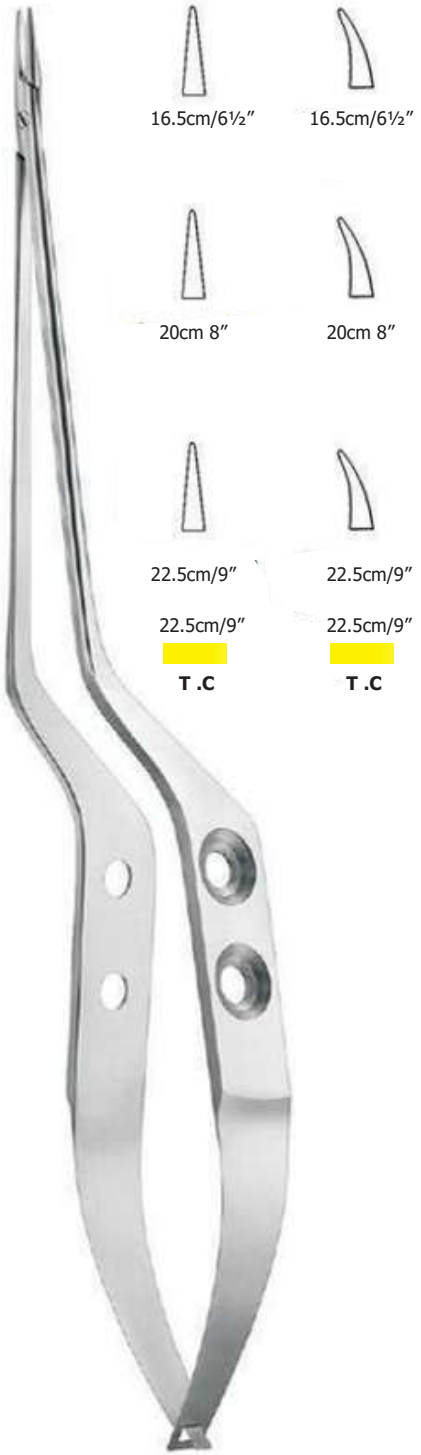

MICRO FORCEPS

HYPOPHYSECTOMY FORCEPS



ADSON
21.5cm/8½
STRAIGHT

ADSON
21.5cm/8½
FORWARD

ADSON
21.5cm/8½
BACKWARD

0.6mm

0.6mm

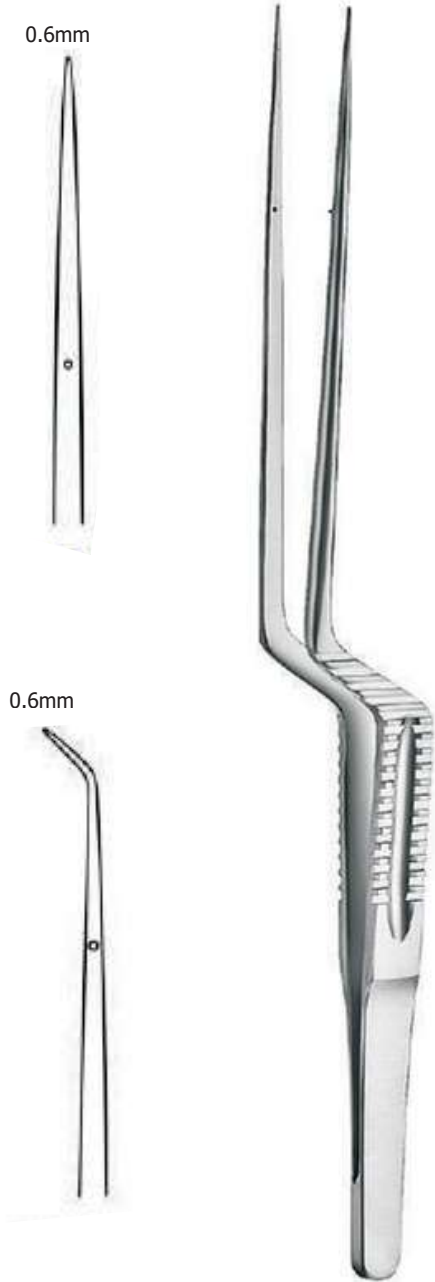

MICRO FORCEPS
18.5cm 7¼"

MICRO FORCEPS



N-10759

YASARGIL
LIGATURE FORCEPS
18.5cm 7¼"

YASARGIL
MICRO FORCEPS

0.3mm

0.6mm

0.9mm

1.2mm

16cm/6¼"
18cm/7"
20cm/8"
22cm/8¾"
24cm/9½"

22cm/8¾"

22cm/8¾"

24cm/9½"

20cm/8"

24cm/9½"

ANGLED

 **TITANIUM**

 **DIAMOND TIP**

 **DIAMOND TIP**

 **DIAMOND TIP**

 **DIAMOND TIP**

YASARGIL TUMOR HOLDING FORCEPS BAYONET SHAPE

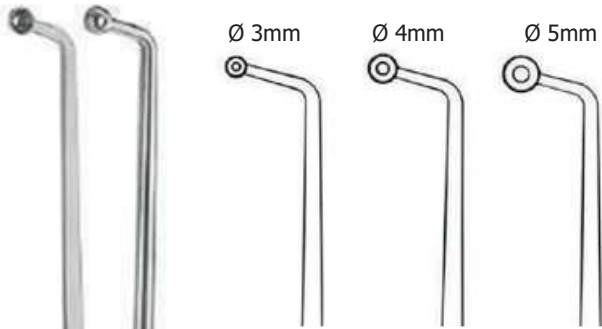

FORWARD

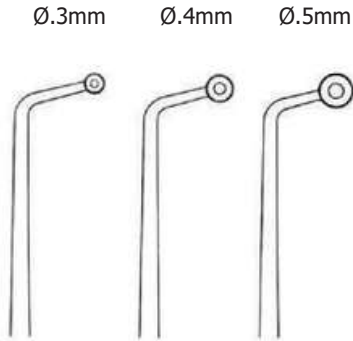

BACKWARD

JAW SPOON SHAPED

23CM/9"

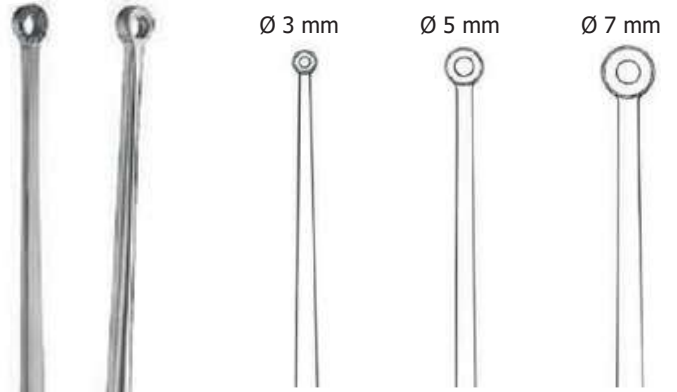

JAW SPOON SHAPED

22cm/8¾"
24cm/9½"

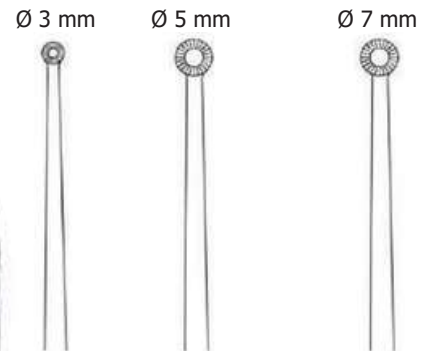

SERRATED FLAT JAW 22cm/8¾"

TOOTH CURETTE JAW- 22cm/8¾"

HUNTUMORHOLDING FORCEPS

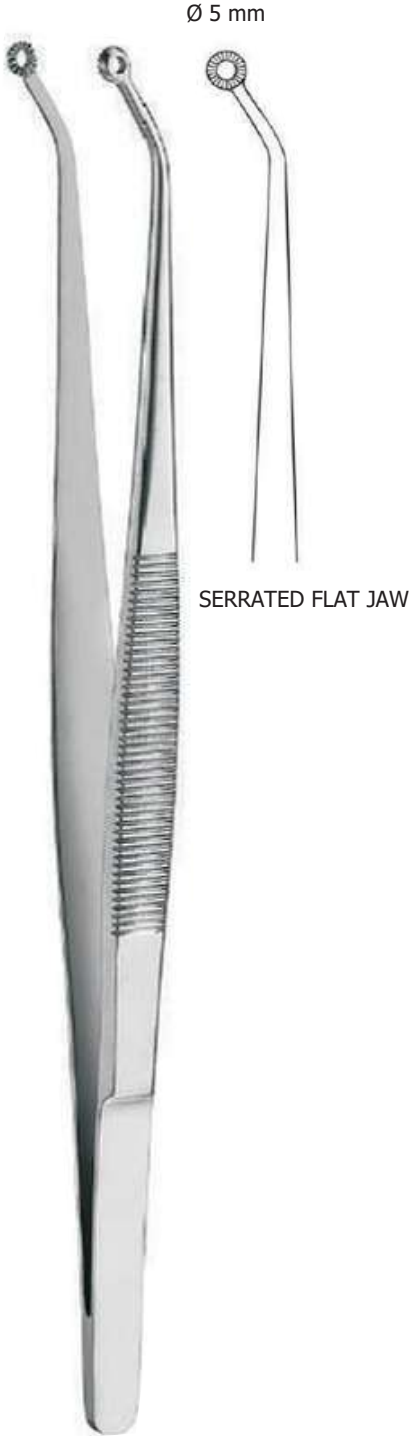

PENFIELD DISSECTORS SET OF FIVE



NO-1

S.S

17.5cm/7"



NO-2

19.5cm/7¼"



NO-3

19.5cm/7¼"



NO-4

20.5cm/8"



NO-5

29cm/11½"

TITANIUM

TITANIUM

NERVE HOOK

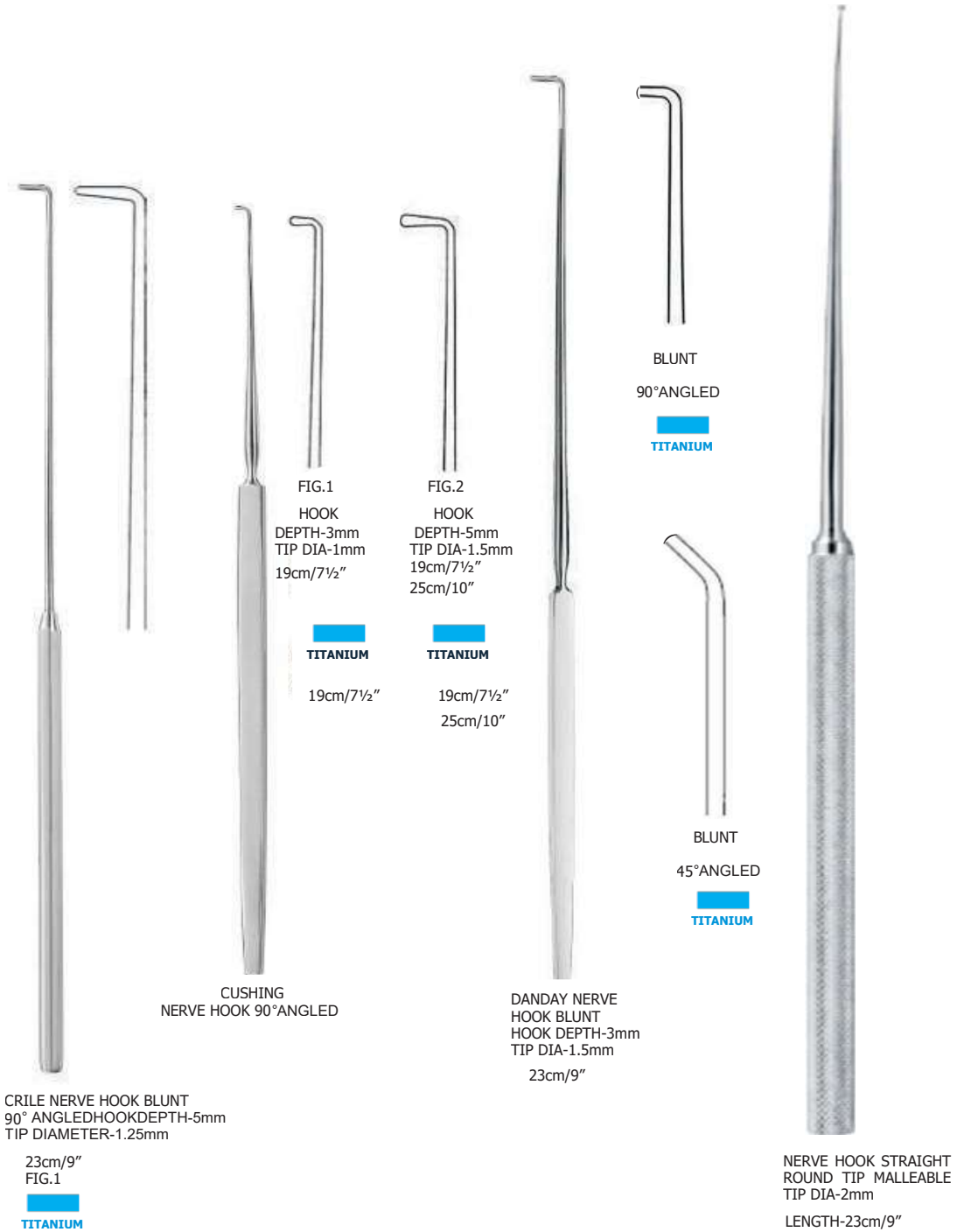

DURAL HOOK



ADSON RECTANGULAR NERVE &
DURA HOOK LENGTH: 19cm/ 7½"



SHARP
TITANIUM



BLUNT
TITANIUM



FRAZIER TYPE DURAL HOOK
LENGTH: 5½"/14cm



SHARP



BLUNT



UPWARDS
CURVED



UPWARDS
STRAIGHT

TITANIUM

YASARGIL SICKLE STYLE KNIFE



UPWARDS
CURVED



DOWNWARDS
CURVED

BLUNT TIP 5mm

TITANIUM

YASARGIL MICRO VESSEL KNIFE



90°
UPWARDS

BLUNT TIP 3mm

TITANIUM

TUMOR KNIFE



90°

BLUNT TIP 3mm

TITANIUM

TUMOR KNIFE



BAYONET SHAPE
20CM/8"

MCELVEEN KNIFE
20CM/8"



MICRO VESSEL
SKIN HOOK SHARP TIP

18,5 cm – 7¼"



JACOBSON MICRO VESSEL
ARACHNOIDS KNIFE

18,5 cm – 7¼"

MICRO INSTRUMENTS



YASARGIL
MICRO RASPATORY ANGLED
TITANIUM

18,5 cm-7¼"



YASARGIL
MICRO RASPATORY ANGLED
2.5mm
TITANIUM

18,5 cm-7¼"



YASARGIL
MICRO RASPATORY
SLIGHTLY CURVED
3.5mm
TITANIUM

18,5 cm-7¼"



YASARGIL
MICRO RASPATORY
STRONGLY CURVED
3.5mm
TITANIUM

18,5 cm-7¼"



YASARGIL
MICRO RASPATORY
CURVED DOWNWARD
BAYONET
TITANIUM

18,5 cm-7¼"



YASARGIL
MICRO RASPATORY
CURVED DOWNWARD
HALF MOON BAYONET
TITANIUM

18,5 cm-7¼"



YASARGIL
MICRO RASPATORY
CURVED UPWARD
HALF MOON BAYONET
TITANIUM

18,5 cm-7¼"



YASARGIL
MICRO SPOON SHARP
BAYONET
TITANIUM

18,5 cm-7¼"

YASARGIL

YASARGIL

CASPAR MICRO EXPLORATION COAGULATION HOOKS



VERRUNDET ROUNDED
24,5 cm/ 9¾"



BALL PROBE
24,5 cm/9¾"



BALL TIP ,ISOLIERT INSULATED
24,5 cm/ 9¾"



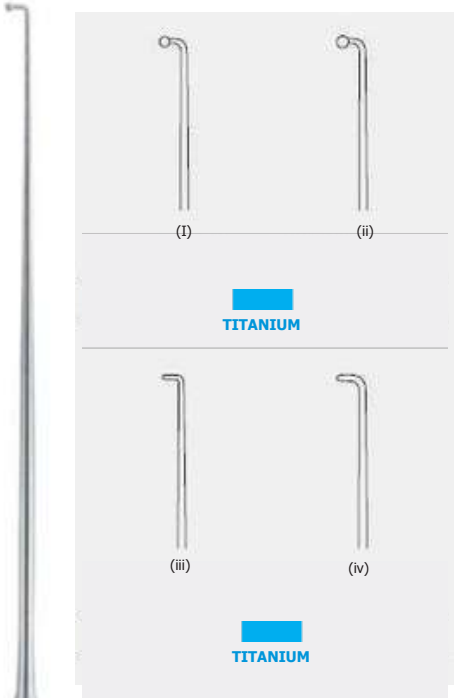

KRAYENBÜHL
NERVE & VESSEL HOOK
18.5cm/7¼"



YASARGIL
LIGATURE GUIDE, PROBE POINTED
19cm/7½"

MICRO INSTRUMENTS

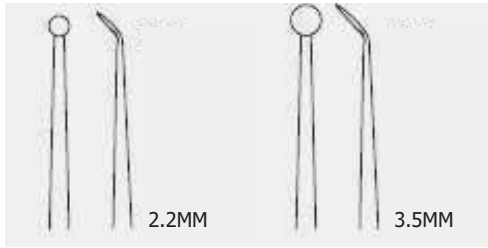

MICRO RASPATORY ROUND BLADE **SHARP**
23 cm – 9"

TITANIUM

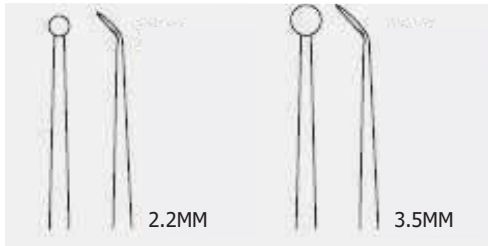

MICRO RASPATORY ROUND BLADE **BLUNT**
23 cm – 9"



TITANIUM

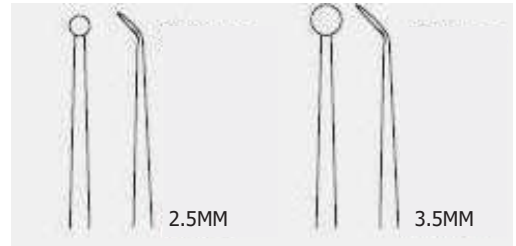

MICRO HOOKS **BLUNT** MICRO HOOKS **SHARP**
23CM – 9" 23CM -9"

TITANIUM



SHARP

TITANIUM



BLUNT

TITANIUM

MICRO RASPATORY
BAYONET UPWARD CURVED
ROUND BLADE 23CM/9"

MICRO INSTRUMENTS



VESSEL DILATOR BALL TIP
MALLEABLE IN **BLACK COATED**
19,0 cm – 7½"

- 0.5MM
- 1.0MM
- 1.5MM

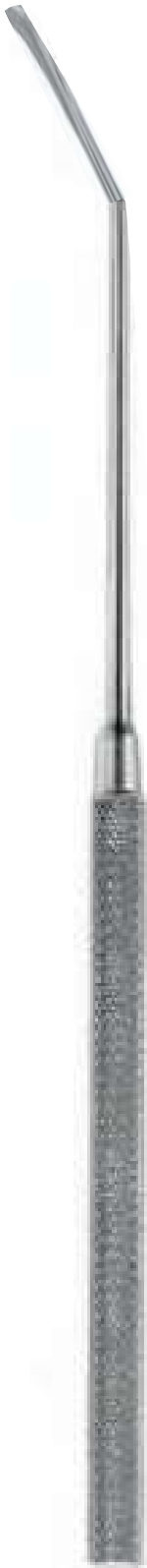

1.0MM



1.5MM



2.0MM



2.5MM

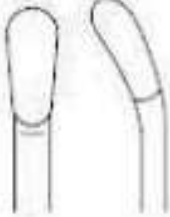

3.0MM

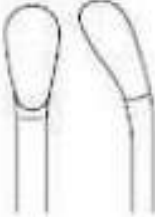

3.5MM

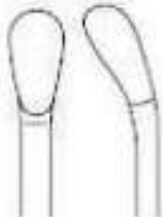

4.0MM

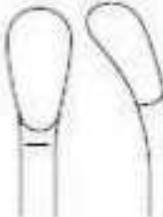

4.5MM

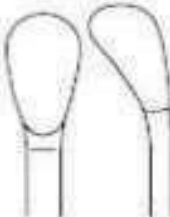

5.0MM

SAMII KNIFE FOR TUMOR TISSUE
23CM cm – 9"



CURVED

1mm

1.5mm

SHARP
2mm

SHARP
3.5mm

SHARP
4.5mm

18,5 cm – 7¼"

20,0 cm – 8"

23,0 cm – 9"

1mm

1.5mm

SHARP
2mm

SHARP
3.5mm

SHARP
4.5mm

18,5 cm – 7¼"

20,0 cm – 8"

23,0 cm – 9"



1 mm

MALLEABLE
23,0 cm – 9"

1mm

1.5mm



3mm

3mm

18.5cm
21.5cm

18.5cm
21.5cm



MICRO SPOON 2.5MM

24,0 cm – 9½"

24,0 cm – 9½"

1/1

MICRO DISSECTOR

YASARGIL MICRO SPOON
BAYONET SHAPE



4.5mm 2mm

CURVED DOWN BLUNT
23 cm – 9"

TITANIUM



CURVED UP BLUNT
23 cm – 9"

TITANIUM

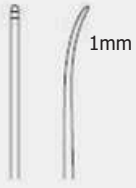

1mm

CURVED UP

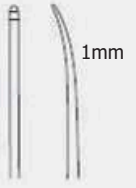

1mm

CURVED DOWN

21 cm – 8³/₄"

TITANIUM

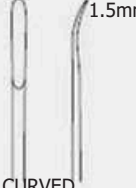

1.5mm

CURVED UP

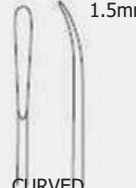



1.5mm

CURVED DOWN

23 cm – 9"

TITANIUM



SHARP
23,0 cm – 9"

TITANIUM

| | |
|-------------|-----|
| CURVED UP | 2mm |
| | 4mm |
| CURVED DOWN | 2mm |
| | 4mm |



23,0 cm – 9"

MICRO SUTURE PUSHER

MICRO DISSECTOR BAYONET SHAPE



RHOTON TYPE
DISSECTORS
7 1/2"

| | | | | | |
|-----------------------------|-----------------------------|---------------|----------------|---------------------|---------------------|
| | | | | | |
| | No.1 | No.2 | No.3 | No.4 | No.5 |
| STAINLESS STEEL TITANIUM | U.C. 1.5mm DISSECTORS | U.C. 1.5mm | BLADE 2.5mm | CURVED ELEVATORS | CURVED ELEVATORS |

RHOTON SET

| | | | | | |
|-----------------------------|----------------|-----------------|----------------|-------------------|----------------|
| | | | | | |
| | No.6 | No.7 | No.8 | No.9 | No.10 |
| STAINLESS STEEL TITANIUM | SMALL 1.5mm | MEDIUM 2.5mm | LARGE 2.7mm | HOOK-SEMI HOOK | SM. CR HOOK |

| | | | | | | |
|-----------------------------|-------|-------|-------|------------|--------------------------------------|----------------------|
| | | | | | | |
| | No.11 | No.12 | No.13 | No.14 | No.15 | No.16 |
| STAINLESS STEEL TITANIUM | | | | U.C. 2.5mm | TELESCOPE DISSECTOR 0 STRAIGHT | DISSECTOR 50° 2mm |

| | | | |
|-----------------------------|------------------------|------------------------|------------------------|
| | | | |
| | No.17 | No.18 | No.19 |
| STAINLESS STEEL TITANIUM | TELESCOPE DISSECTOR | TELESCOPE DISSECTOR | TELESCOPE DISSECTOR |



3MM

STRAIGHT-
TOTAL LENGTH-203MM
WORKING LENGTH-98MM

TITANIUM

STRAIGHT-
TOTAL LENGTH-220MM
WORKING LENGTH-115MM

TITANIUM

**STRAIGHT
MALLEABLE SHAFT**
TOTAL LENGTH- 203MM
WORKING LENGTH-98MM

ANGLED 15 DEGREE-
TOTAL LENGTH- 203MM
WORKING LENGTH-98MM

TITANIUM

ANGLED 45 DEGREE-
TOTAL LENGTH- 203MM
WORKING LENGTH-98MM

TITANIUM

ANGLED 90 DEGREE-
TOTAL LENGTH- 203MM
WORKING LENGTH-98MM

TITANIUM

1/1

MICRO BAYONET PROBE TEAR
DROP TIP ,TIP WIDTH - 3MM

MICRO INSTRUMENTS



VESSEL DILATOR

Ø 0.5mm
12.5cm - 5"

Ø 1mm
12.5cm - 5"

Ø 1.5mm
12.5cm - 5"



VESSEL SPREADER

16,0 cm - 6 1/4"

BIMERL



JACOBSON
PROBE WITH BALL TIP

18,5cm - 7 1/4"

Ø 0.5mm-

Ø 1.0mm-

Ø 1.5mm-

JACOBSON
VESSEL PROBE &
SUPPORTER

18,5 cm - 7 1/4"

JACOBSON
SUTURE PUSHER

18,5 cm - 7 1/4"

JACOBSEN



115mm

HARDY RING CURETTES

Ø 2.5mm
90°

Ø 4mm
90°

Ø 5mm
90°

Ø 2.5mm
90°

Ø 4mm
90°

Ø 5mm
90°

Ø 2.5mm
90°

Ø 4mm
90°

Ø 5mm
90°

| |
|-------|
| UP |
| DOWN |
| RIGHT |
| LEFT |

Ø 2.5mm
45°

Ø 4mm
45°

Ø 5mm
45°

TITANIUM

| |
|-------|
| UP |
| DOWN |
| RIGHT |
| LEFT |

TITANIUM

Ø 5mm
CURVED
LEFT

Ø 5mm
CURVED
RIGHT

Ø 5mm

Ø 5mm

TITANIUM

PITUITARY INSTRUMENTS



HORIZONTAL

VERTICAL

RAY CURETTE
18.0cm 7"



140mm

6mm

4mm

HARDY CURETTE MALLEABLE
26,0 cm – 10¼"

PITUITARY INSTRUMENTS

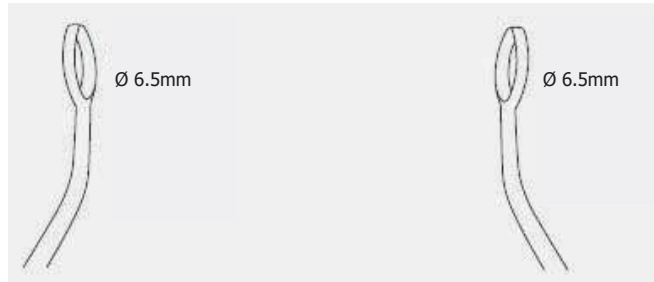

CURVED to THE RIGHT

CURVED to THE LEFT



ANGLED UP

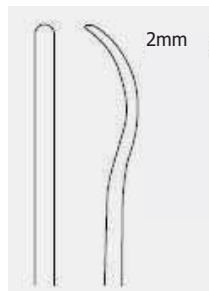

RASPATORY
21,5 cm – 8½"

NICOLA CURETTE
MALLEABLE 21.5CM/8½"

PITUITARY INSTRUMENTS



24 cm – 9½"



LEFT RIGHT

HARDY ENUCLEATOR
BLUNT BAYONET 24.5CM

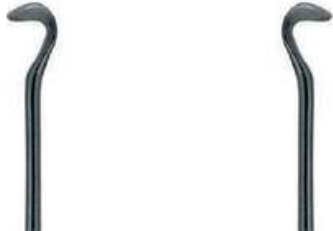

LEFT RIGHT

LANDOLT ENUCLEATOR
BLUNT MALLEABLE 26CM



LEFT RIGHT

HARDY DISSECTOR
SHARP INNER EDGE
BAYONET 24.5CM



LEFT RIGHT

HARDY FAHLBUSCH DISSECTOR
SHARP INNER EDGE BAYONET 24CM



HARDY

IMPLANT
FORK



26cm/10¼"



PITUITARY INSTRUMENTS



26cm-10¼"

| | | | | |
|--|---|--|--|-----------------------------------|
| | <p>2mm DISSECTOR RIGID BAYONET 26CM</p> | | | <p>1.7mm HOOK BLUNT RIGID</p> |
|--|---|--|--|-----------------------------------|

| | |
|-----------------------|-----------------------|
| <p>LANDOLT REULEN</p> | <p>LANDOLT REULEN</p> |
|-----------------------|-----------------------|

| | |
|--|--|
| | |
|--|--|

FAHLBUSCH

LANDOLT REULEN

| | |
|--|---|
| | <p>Ø 2mm SPOON MALLEABLE BAYONET 26CM FAHLBUSCH</p> |
|--|---|

FAHLBUSCH

| | | | |
|--|---|--|---|
| | <p>2.2mm LANDOLT REULEN RASPATORIES, RIGID BAYONET 26CM</p> | | <p>3.2mm LANDOLT REULEN RASPATORIES, RIGID BAYONET 26CM</p> |
|--|---|--|---|

PITUITARY INSTRUMENTS

SHAFT Ø 0,9mm



19,0 cm – 7½"

MICRO SCISSORS



MICRO FORCEPS



MICRO CUP FORCEPS

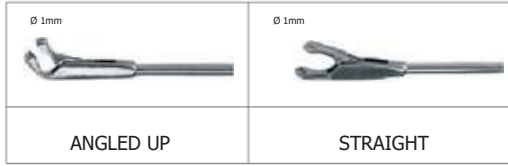

MICRO FORCEPS

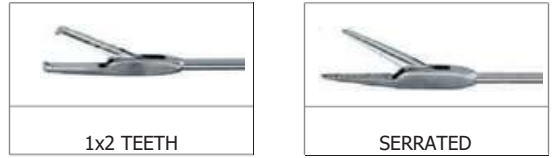

MICRO SUCTION CANNULA

ATRAUMATIC & RIGID SUCTION CANNULA WITH KEY HOLE

WORKING LENGTH
140mm



1.4mm **4FR** 2.0mm **6FR** 2.7mm **8 FR 1**

THE BALL TIP AT THE END OF THE INSTRUMENT ALLOWS GENTLE PREPARATION & STABLE ATRAUMATIC RETRACTION.

SUCTION CANNULAS Rotatable with key hole

| Working LENGTH | S | M | L |
|----------------|-------|--------|--------|
| | 90 mm | 110 mm | 150 mm |

- 1.5mm
- 2.0mm
- 3.0mm
- 4.0mm
- 5.0mm

THE BALL TIP AT THE END OF THE INSTRUMENT ALLOWS GENTLE PREPARATION & STABLE ATRAUMATIC RETRACTION.

SUCTION

SUCTION CANNULAS WITH IRRIGATION KEY HOLE
(Special design for skull base surgery)



SIZE
5X4 MM
4X3MM
3X2MM
2X1MM

SUCTION CANNULAS WITH KEY HOLE



TOTAL LENGTH

M 200mm 8" L 230mm 9"

M 200mm 8" L 230mm 9"

- 4 FR \odot 1.4mm
- 6 FR \odot 2.0mm
- 8 FR \odot 2.7mm
- 10 FR \odot 3.3mm
- 12 FR \odot 4.0mm

SUCTION CANNULAS WITH KEY HOLE, BALL ENDED BLACK COATED



TOTAL LENGTH

M 200mm 8"

- 4 FR \odot 1.4mm
- 6 FR \odot 2.0mm
- 8 FR \odot 2.7mm
- 10 FR \odot 3.3mm

SUCTION CANNULAS CURVED SUCTION INSTRUMENTS

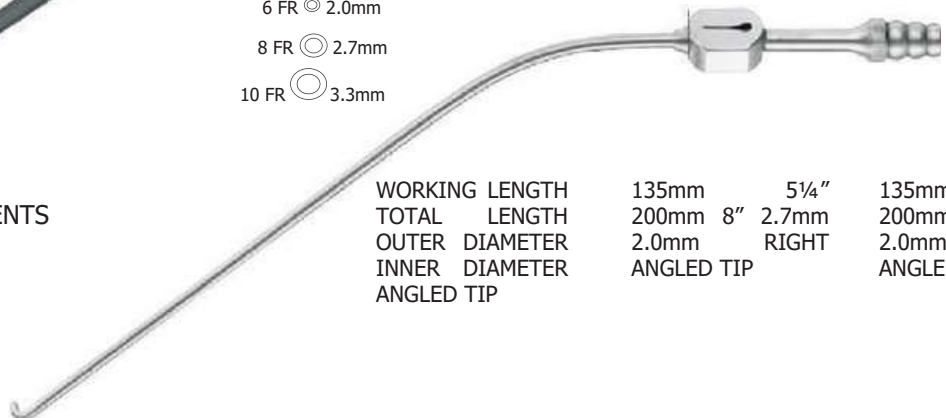

WORKING LENGTH
TOTAL LENGTH
OUTER DIAMETER
INNER DIAMETER
ANGLED TIP

135mm 5/4"
200mm 8" 2.7mm
2.0mm RIGHT
ANGLED TIP

135mm 5/4"
200mm 8" 2.7mm
2.0mm LEFT
ANGLED TIP

SUCTION



SIZE
2.0 MM
2.7 MM
3.3 MM
4.0 MM

FRAZIER SUCTION
TUBES, BALL END 8"



SIZE
2.5 MM
3.5 MM
4.5 MM

MONOPOLAR
SUCTION TUBE 8"



SIZE
1.4X0.9
1.5X1.2
2.3X1.7
3.3X2.3
4.5X2.0

SUCTION
IRRIGATION TUBE
WITH CHANNEL, 7"



ZOLLNER SUCTION
TUBES WITH 4 DETACHABLE TIPS



SIZE
3 FR
5 FR
7 FR
9 FR
12 FR

BARRON SUCTION
TUBE



2119
CABLE



SIZE
12
14
16
18
20
21
22
23
24

DETACHABLE
VERHOEVEN SUCTION
TUBES



VERHOEVEN
SUCTION
TUBES ADAPTOR



BRAIN CANNULA SHARP OPEN
END WITH BLUNT OBTURATOR

1.5mmx9cm
2.0mmx9cm
2.5mmx9cm



BRAIN CANNULA WITH 2 HOLES
CLOSE END

1.5mmx9cm
2.0mmx9cm
2.5mmx9cm



BRAIN CANNULA WITH 1 HOLES
CLOSE END

1.5mmx9cm
2.0mmx9cm
2.5mmx9cm

INSTRUMENTS SET FOR BURR HOLE



A



B



C



D

BURRS & PERFORATORS

N-10016 CEREBELLAR EXTENSION
N-10017 HUDSON BRACE

CONICAL BURR

- SIZE
9mm
11mm
13mm
14mm
16mm
18mm

SPHERICAL BURR

- SIZE
1 mm
1.5mm
3mm
4mm
18mm

PERFORATOR BURR

- SIZE
10mm
12mm
15mm
17mm
20mm

MCKENZIE SKULL PERFORATOR DRILL

- SIZE
13mm

SPHERICAL BURR WITH DURA GUARD

- 22mm

SKULL INSTRUMENTS



175 mm
LARGE PATTEM



155 mm
CRUTCHFIELD
MEDIUM PATTEM



SPARE PIN



CRUTCHFIELD
GUARDED DRILL
7cm/2³/₄"
Ø 3.5mm
DRILL POINT



105 mm
CRUTCHFIELD
SMALL PATTEM



CRUTCHFIELD
GUARDED DRILL
7cm/2³/₄"
Ø 5mm
DRILL POINT



HALTER CERVICAL
TRACTION CLAMP

SKULL INSTRUMENTS



RANEY SCALP HEMOSTASIS CLIPS
(DISPOSABLES)



15.5cm 6¼"
APPLYING and REMOVING FORCEPS
SCALP HEMOSTASIS CLIPS



HEMOLIGATING CLIP APPLIER
SMALL-100
MEDIUM-200
LARGE-300



23cm/9"
CONE SKULL PUNCH
FOR SKULL THICKNESS UP TO 12mm

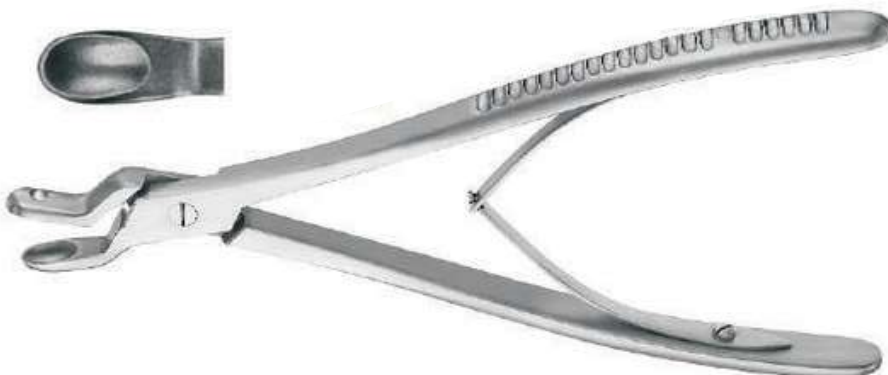

20.5cm/8"
BURR HOLE PROTECTION FORCEPS

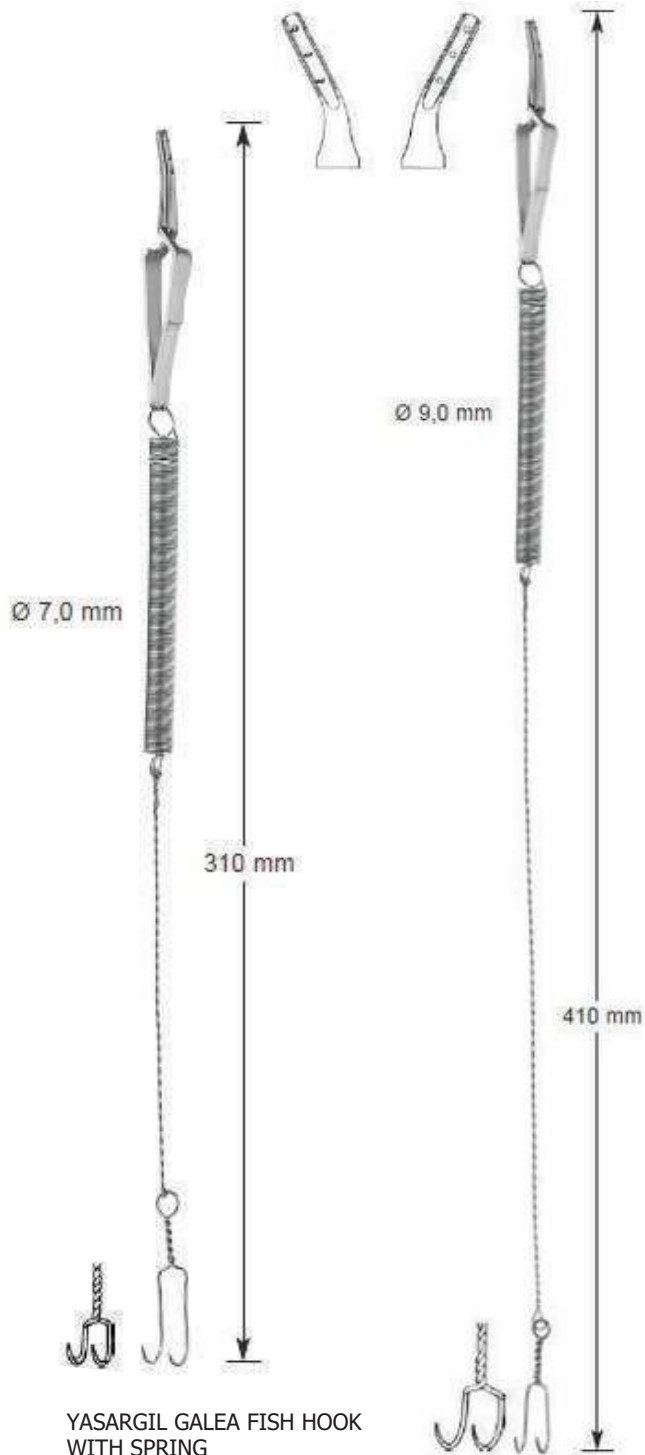

YASARGIL GALEA FISH HOOK
WITH SPRING

31cm/12¼"

YASARGIL GALEA FISH HOOK
WITH SPRING

41cm/16"



PERITONEAL SHUNT TROCAR
WITH OBUTURATOR
3MM AND SHEATH 4MM
LENGTH 6"



SHUNT TUNNELLER

14"
18"
24"



GIGLE SAW GUIDE
 33cm/13" ADULT
 26cm/10½" PAEDTRIC



GIGLI SAW HANDLE
7368

1 PAIR



GIGLI SAW WIRE

25cm/10"
 30cm/12"

50cm/20"
 60cm/24"
 70cm/28"



CAIRNS SKULL FLAP ELEVATOR



SCOVILLE TREPHINE WITH ADJUSTABLE PIN

- TREPHINE 1.0"
- TREPHINE 1.5"
- TREPHINE 1.75"
- TREPHINE 2.0
- TREPHINE 2.25"
- TREPHINE 2.5"
- TREPHINE 3



DINGMAN MOUTH GAG
WITH 3 TONGUE PLATES

DINGMAN MOUTH GAG
WITH 3 TONGUE PLATES
Fiber Optic carrier



K-WIRE
INTRODUCER



K-WIRE 6"

- Ø 0,8 mm
- Ø 0,9 mm
- Ø 1,0 mm
- Ø 1,1 mm
- Ø 1,2 mm
- Ø 1,3 mm
- Ø 1,4 mm
- Ø 1,5 mm
- Ø 1,6 mm
- Ø 1,7 mm
- Ø 1,8 mm
- Ø 1,9 mm
- Ø 2,0 mm
- Ø 2,2 mm
- Ø 2,5 mm
- Ø 3,0 mm



MICRO
BONE DRILL



UNIVERSAL
HAND DRILL



DRILL BIT

- 1.5 3.5
- 2.0 4.0
- 2.5 4.5
- 3.0 5.0

TRANSORAL INSTRUMENTS

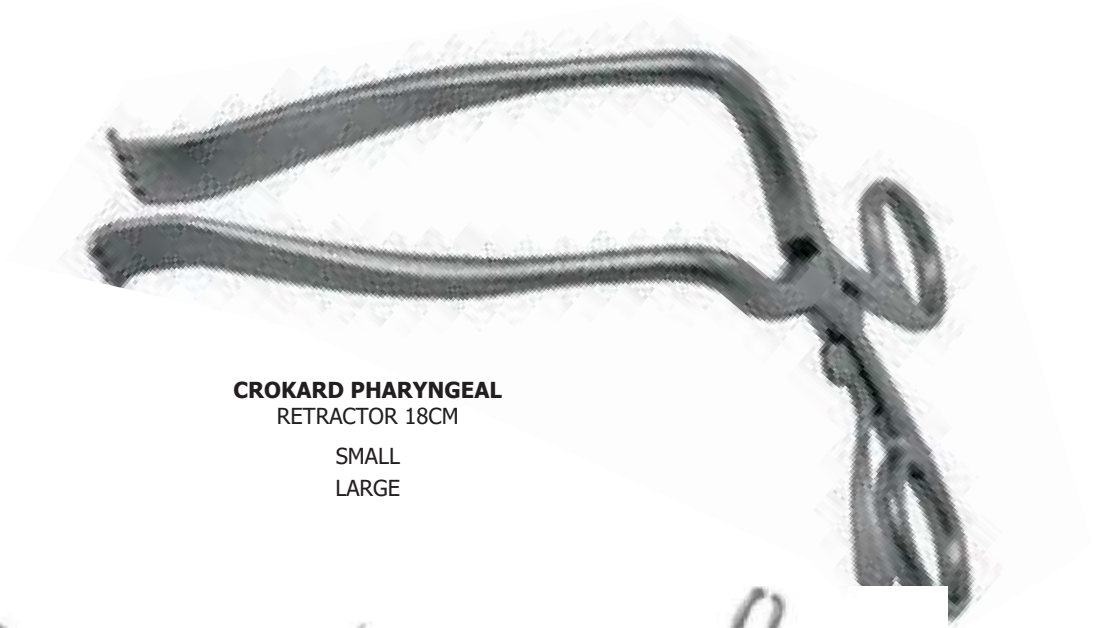

CROKARD PHARYNGEAL
RETRACTOR 18CM

SMALL
LARGE



CROKARD LIGAMENT
GRASPING TOOTH FORCEPS, 25CM



CROKARD BAYONET
MICRO DISSECTOR, 25CM



CROKARD ODONTOID
PEG GRASPING FORCEPS, 23CM

BLADES



B.P. Handle 3
LONG HANDLE
B.P. Handle 3



B.P. Handle 4
LONG HANDLE
B.P. Handle 4



B.P. Handle 7



ROUND. Handle 3



B.P. Handle Curved



VERTICAL CUTTING
HORIZONTAL CUTTING
VERTICAL CUTTING



ROUND HANDLE



No.10



No.11



No.12



No.15



No.21



No.23

CUTTER



Liston



14 cm – 51/2?



17 cm – 63/4?



20 cm – 8?



22 cm – 83/4?



14 cm – 51/2?



17 cm – 63/4?



20 cm – 8?



22 cm – 83/4?



Liston-mini



15 cm – 6?



15 cm – 6?

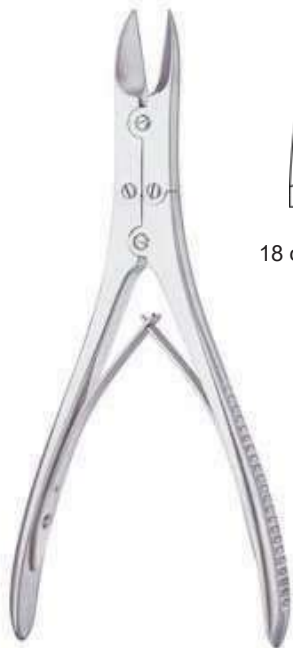

Ruskin-Rowland



18 cm – 71/8?



18 cm – 71/8?

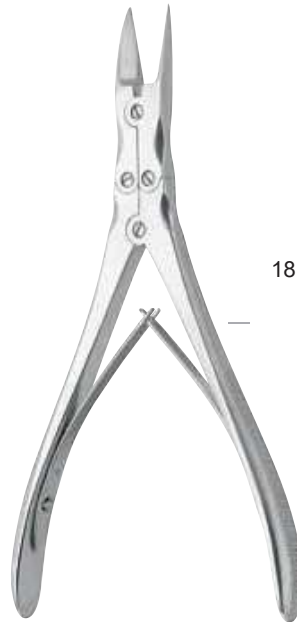

McIndoe



18 cm – 71/8?



18 cm – 71/8?

CUTTER



Liston-Stille

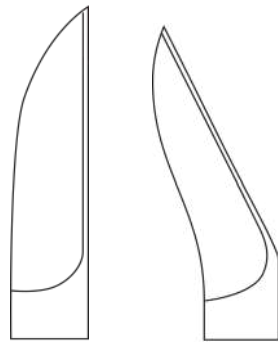

28 cm – 11?

28 cm – 11?



Liston-Key

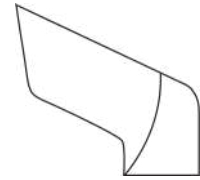

26 cm – 10 1/4?

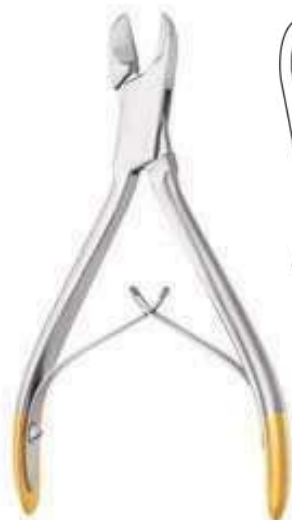

WIRE CUTTER

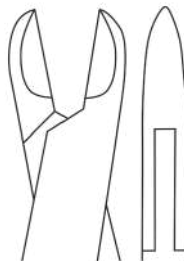

12 cm – 4 3/4?

T.C

CUTTER



TOP CUTTER

27 cm-10 1/2"

T.C



TC WIRE CUTTER

23 cm - 9"

T.C



WIRE CUTTER

19 cm - 7 1/2"

23 cm - 9"

T.C



DE VIBISS SKULL PUNCH



RIB SHEARS



WIRE CUTTING PLIER

17.5 cm-7"

BIPOLAR



19.5 cm
25cm
BIPOLAR COAGULATION
FORCEPS BAYONET TYPE
NON STICK



19.5 cm
BIPOLAR COAGULATION
FORCEPS BAYONET TYPE
WITH TWO PINS
NON STICK



19.5 cm
BIPOLAR COAGULATION
FORCEPS BAYONET TYPE
WITH SUCTION
NON STICK



16 cm
19.5 cm
BIPOLAR COAGULATION
FORCEPS (ST.)
NON STICK



16 cm
19.5 cm
BIPOLAR COAGULATION
FORCEPS (ST.)
WITH TWO PINS
NON STICK



16 cm
19.5 cm
BIPOLAR COAGULATION
FORCEPS CURVED
NON STICK



16 cm
19.5 cm
BIPOLAR COAGULATION
FORCEPS CURVED
WITH TWO PINS
NON STICK



16 cm
19.5 cm
BIPOLAR COAGULATION
FORCEPS CURVED
BAYONET NON STICK



16 cm
19.5 cm
BIPOLAR COAGULATION
FORCEPS CURVED
WITH SUCTION
BAYONET NON STICK



16 cm
19.5 cm
BIPOLAR COAGULATION
FORCEPS CURVED
WITH TWO PINS
BAYONET NON STICK

BIPOLAR



16 cm
19.5 cm
25 cm
BIPOLAR COAGULATION
FORCEPS BAYONET TYPE



16 cm
BIPOLAR
COAGULATION
FORCEPS BAYONET TYPE
WITH TWO PINS



16 cm
19.5 cm
BIPOLAR
COAGULATION
FORCEPS BAYONET TYPE
WITH SUCTION



16 cm
19.5 cm
BIPOLAR
COAGULATION
FORCEPS (ST.)



16 cm
19.5 cm
BIPOLAR
COAGULATION
FORCEPS (ST.)
WITH TWO PINS



ANGLED BIPOLAR
FORCEPS



16 cm
19.5 cm
BIPOLAR
COAGULATION
FORCEPS CURVED



16 cm
19.5 cm
BIPOLAR COAGULATION
FORCEPS CURVED
WITH TWO PINS



16 cm
19.5 cm
BIPOLAR
COAGULATION
FORCEPS CURVED
BAYONET



16 cm
19.5 cm
BIPOLAR
COAGULATION
FORCEPS CURVED
WITH SUCTION
BAYONET



16 cm
19.5 cm
BIPOLAR
COAGULATION
FORCEPS CURVED
WITH TWO PINS
BAYONET



CABLE



BIPOLAR CABLE FLAT PIN



BIPOLAR CABLE TWO PIN

BIPOLAR



11cm
14cm

ADSON FORCEPS
11cm, 14cm



McPHERSON STRAIGHT FORCEPS 8cm



McPHERSON CURVED FORCEPS 9cm



JEWELER FORCEPS 11cm



BIPOLAR FORCEPS 10cm



14cm

ADSON FORCEPS
11cm, **Tip-0.4mm**
NON STICK



McPHERSON STRAIGHT FORCEPS 8cm **Tip-0.4mm**
NON STICK



McPHERSON CURVED FORCEPS 9cm **Tip-0.4mm**
NON STICK



JEWELER FORCEPS 11cm **Tip-0.4mm**
NON STICK



BIPOLAR FORCEPS
Tip-0.4mm 10cm
NON STICK

GENERAL FORCEPS

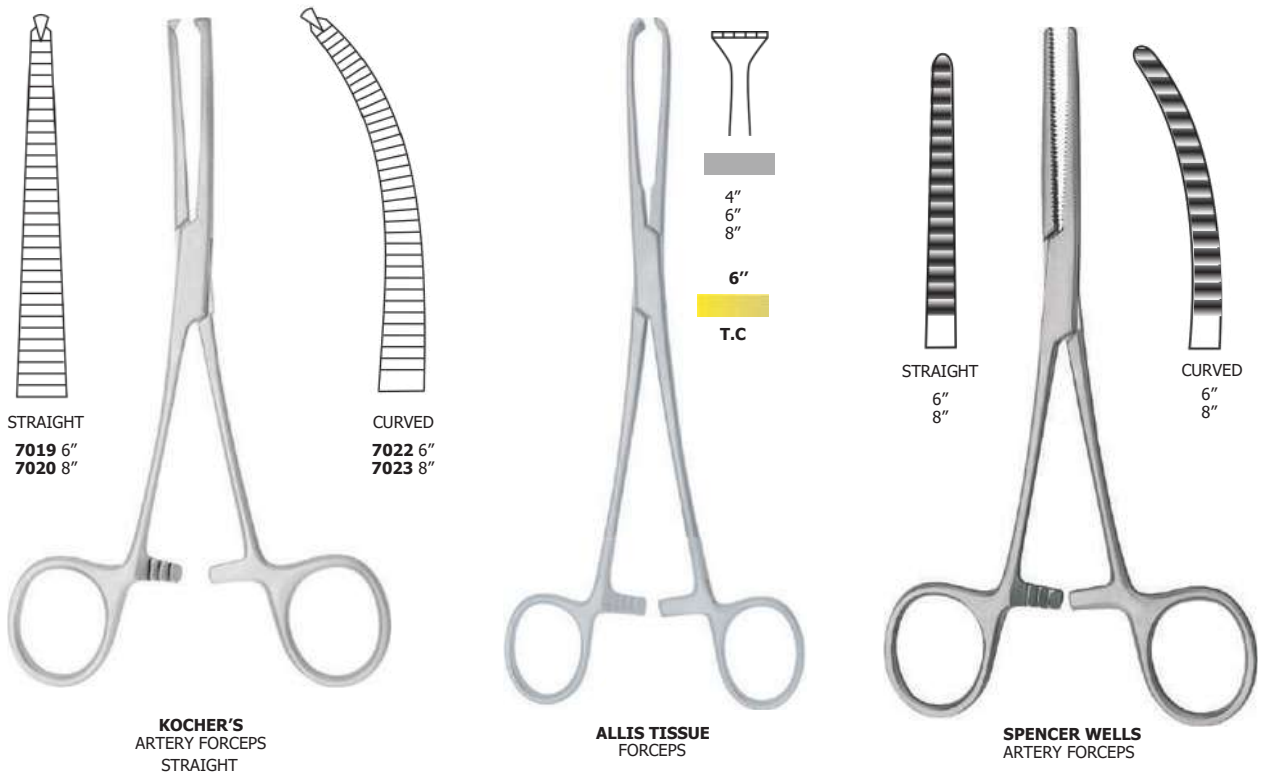
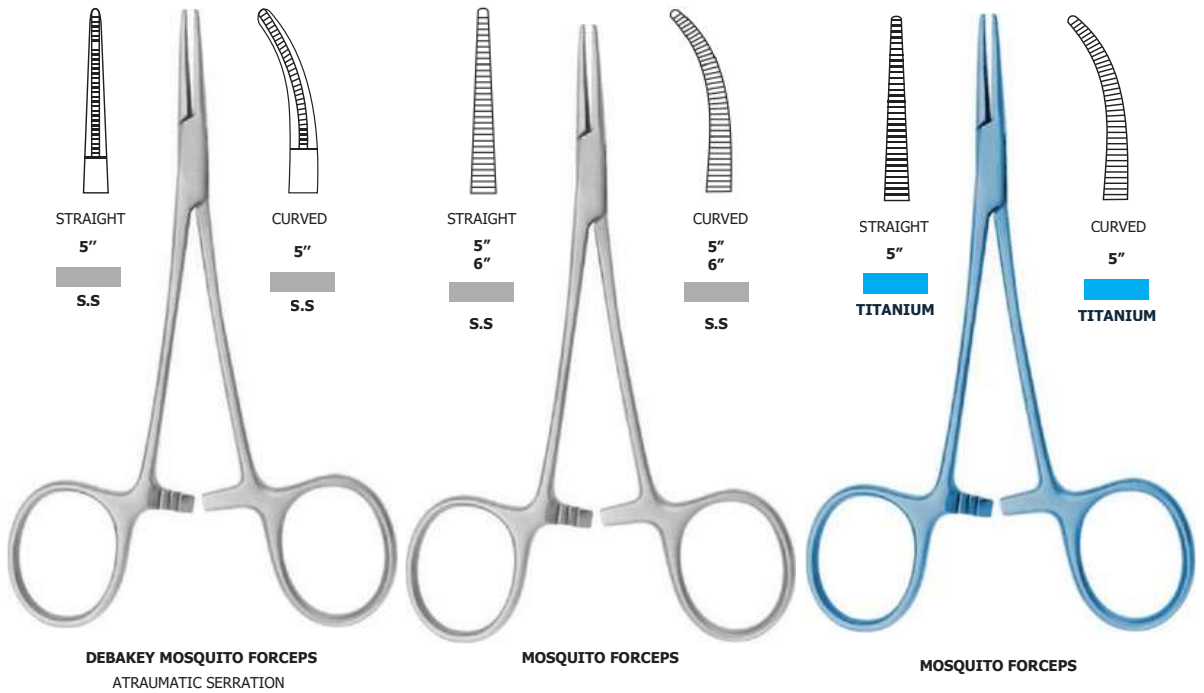

GENERAL FORCEPS



DANDY SCALP HEMOSTATIC FORCEPS
CURVED ON SIDE SERRATED 14CM



6"
8"
10"
MIXTURE LIGATURE
RIGHT ANGLED FORCEPS

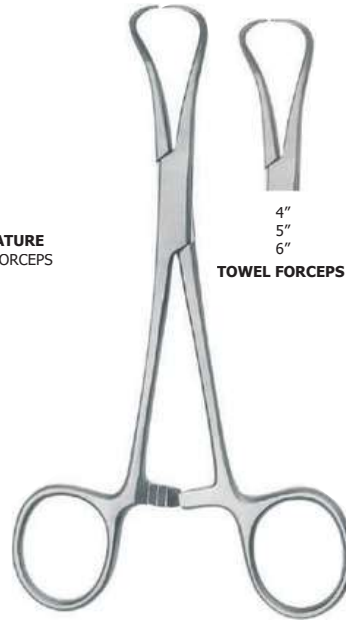

4"
5"
6"
TOWEL FORCEPS



TOWEL CLIP
CROSS ACTION

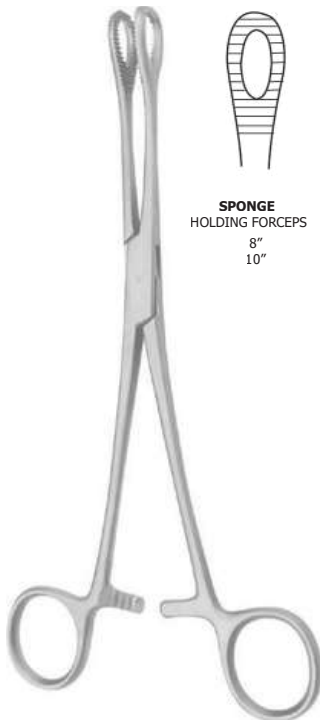

SPONGE
HOLDING FORCEPS
8"
10"



CHEATLE
JAR



CHEATLE
FORCEPS
10"

LIGHTS



**FIBER OPTIC
HEAD LIGHT BAND**



**LED LIGHTS HEADBAND
WITH REACHABLE BATTERY 5 V**



**HALOGEN
FIBER OPTIC COLD LIGHT SOURCE
DOUBLE POINT 24V-250 W**



**HALOGEN
FIBER OPTIC COLD LIGHT SOURCE
SINGLE POINT 15 V-150 W**



FIBER OPTIC CABLE

3.5mm LENGTH 230cm
4.5mm LENGTH 230cm



**ULTRA COMPACT MINI
XENON LIGHT SOURCE 300W**



LED LIGHTS SOURCE

HOLLOWWARE INSTRUMENTS



SURGICAL TRAY WITH LID
HEAVY STAINLESS STEEL

6" x 9"
7" x 11"
8" x 10"
10" x 12"
12" x 15"



DRESSING DRUMS
SEAMLESS STAINLESS STEEL

6" x 6"
9" x 9"
9" x 11"



MEASURING BOWL



MICRO INSTRUMENT POINTS



BOWL
STAINLESS STEEL

3"
4"
5"
6"
8"



KIDNEY TRAY

8"
10"



**INSTRUMENTS STERILIZING
PERFORATOR BOX**
STAINLESS STEEL

8" x 4" x 2"
11" x 7" x 2"
12" x 10" x 3"
14" x 10" x 2"



AUTOClave INSTRUMENT BOX
WITH SILICONE MATT
STAINLESS STEEL

8" x 4" x 1"
9" x 8" x 1"
14" x 8" x 1"



HEALTHCORE

VENTURES

build.scale.expand.

Unit no 157, Kaliandas Udyog Bhavan, near Century Bazar, Prabhadevi, Mumbai- 400025

Tel: +91 86554 11521

Email: sales@healthcoreventures.com

Web: www.healthcoreventures.com